



Kent Academic Repository

Ziai, Mohamed A. and Batchelor, John C. (2015) *Passive UHF RFID Tilt Sensor*.
In: IEEE ICEAA, 7-11 September 2015, Turin.

Downloaded from

<https://kar.kent.ac.uk/51048/> The University of Kent's Academic Repository KAR

The version of record is available from

<http://www.iceaa.net/j3/>

This document version

Author's Accepted Manuscript

DOI for this version

Licence for this version

UNSPECIFIED

Additional information

Versions of research works

Versions of Record

If this version is the version of record, it is the same as the published version available on the publisher's web site. Cite as the published version.

Author Accepted Manuscripts

If this document is identified as the Author Accepted Manuscript it is the version after peer review but before type setting, copy editing or publisher branding. Cite as Surname, Initial. (Year) 'Title of article'. To be published in *Title of Journal*, Volume and issue numbers [peer-reviewed accepted version]. Available at: DOI or URL (Accessed: date).

Enquiries

If you have questions about this document contact ResearchSupport@kent.ac.uk. Please include the URL of the record in KAR. If you believe that your, or a third party's rights have been compromised through this document please see our [Take Down policy](https://www.kent.ac.uk/guides/kar-the-kent-academic-repository#policies) (available from <https://www.kent.ac.uk/guides/kar-the-kent-academic-repository#policies>).

Passive UHF RFID Tilt Sensor

M.A. Ziai

J.C. Batchelor

Abstract – In this paper we introduce a bio-axis passive wireless UHF RFID tilt sensor for applications such as to increase safety in warehouse environment and damage detection in consumer goods and where long term monitoring of the product is essential without the need to supply power to the sensors. Simulation and prototype testing indicate it is possible to detect and isolate tilting in 3 axes.

1 INTRODUCTION

Tilt sensors are used to measure slope and tilt within a limited range of motion. Various types of tilt sensor such as solid pendulum tilt, liquid pendulum tilt, micro-electro-mechanical system tilt, and compounding tilt detectors are commonly used in the control of automatic tilt adjusting platforms. Tilt sensors are applied in many fields, such as communications, consumer electronics products, construction engineering, geo-sensing of land movements, electro-mechanical equipment, tanks, ships, cars, radar systems, missiles and so on.

Radio Frequency Identification (RFID) is an established technology for asset tracking. Market forecasts indicate that by 2022 more than 56 billion radio frequency tags will be sold annually to retail consumer goods businesses in Europe alone with market share of at least 25% of the total identification volume in supply chain [1].

In 2009/10 the storage, warehousing and road haulage industries reported over 8500 work related accidents to the Health and Safety Executive (HSE) and Local Authorities in UK. Almost 1600 of these accidents were classified as major injuries such as fractures and amputations [2]. In cases where personnel were injured, companies could be heavily fined for safety failings. This issue could be addressed by transforming into passive tilt sensors the UHF RFID tags that are already applied for asset management. These new devices could determine the tilt and roll of tagged products during transportation and improve safety monitoring for handling staff on a long-term and continual basis without the need to incorporate batteries on the tags.

2 TILT SENSOR DESIGN

The passive UHF tilt sensor proposed in this publication is comprised of an *antenna* and *detuning* lines and the *tilt sensing* device. The structure is etched on 1.6 mm thickness FR4 substrate. A simplified schematic of the design is given in Fig.1 (a). The tilt sensor device has a recess machined in PVC polymer fitted above the antenna. Two pairs of

low-profile mini-switches have been designed and fitted on the inside face of the recess. The switch pairs are connected to the tag antenna port via *detuning* lines. The switches in each pair are mounted opposite each other across the recess, and the two pairs are in orthogonal planes. The detuning line lengths at the 0°, 90°, 180° and 270° connections are $L1$, $L2$, $L3$ and $L4$ respectively. A steel ball is placed inside the recess and is free to travel in any direction inside the recess as shown in Fig.1 (b).

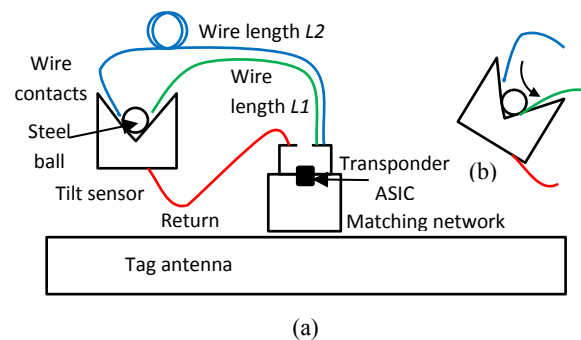

Figure 1: (a) tilt sensing tag schematic showing 2 of 4 wire connections, (b) tilt sensor tilted in one axis.

2.1 Operation Principles

When the tag is in the horizontal position (*un-tilted*), Fig. 1(a), the ball is centered in the recess and makes no connection with any of the switches. If the tag is now tilted in one axis, the steel ball will come into contact with one switch and connect one of the *detuning* lines to the antenna port, Fig. 1(b). The resulting connection affects the antenna matching to the RFID ASIC. Since the current path is different for each of the four tilt directions, each is associated with a different mismatch and therefore with identifiable activation powers. Therefore not only the tilt, but also the direction of the tilt can be specified.

2.2 Antenna Design

A long range platform tolerant antenna was designed on a 1.6 mm FR4 for applications in electromagnetically harsh environments, where close proximity to metallic or water-rich platforms must have little effect on the sensor performance. The antenna and the sensing elements are encapsulated in Acrylonitrile Butadiene Styrene (ABS) casing to protect the antenna and the sensing element against mechanical impact and corrosive chemicals.

¹ School of Engineering and Digital Arts, University of Kent, UK .
e-mail: J.C. Batchelor@Kent.ac.uk, tel.: +44 (0) 1227 827004. e-mail: M.A.ziai_5@kent.ac.uk

The planar antenna is designed by folding a wide conductor to form a narrow slot in the center as shown in Fig. 2, with the dimensions given in Table 1. The radiating element of the antenna and the *detuning* lines (L1-L4) are isolated from the platform by cladding the opposite face of the FR4 substrate with a thin conductive layer. There are no via connections required between the radiating element and the conductive layer to reduce the complexity of the tag for potential manufacture by additive technology. An RFID ASIC is connected across the open ends of the folded conductor to respond to the UHF RFID reader and provide a unique identification. The *detuning* lines (shown as free wires in Fig.1) are etched as convoluted structures and are connected to the antenna port via the tilt switches in the recess as shown in Fig. 1.

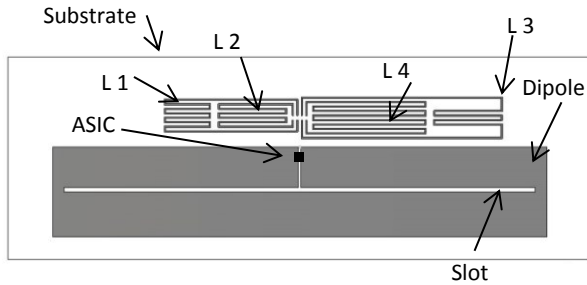

Figure 2: Tilt sensor antenna structure with meandered detuning lines.

Table1: Tag antenna dimensions

Element	Length mm	Width mm	Thickness mm
Dipole	110	20	0.02
Slot	105	1	-
L1	133	0.3	0.02
L 2	103	0.3	0.02
L 3	161	0.3	0.02
L 4	216	0.3	0.02
Conducting layer	130	35	0.02
Substrate	130	35	1.6

3 SIMULATED RESULTS

The tag antenna structure without the meandered sensing lines was initially designed and tuned in CST Microwave Studio to respond at the American RFID frequency band (905-928MHz). The sensing section was then added and retuned to have maximum power transmission between the antenna and the ASIC when in the *un-tilted* position (all tilt switches open) as shown in Fig. 3. Maximum read range is achieved when *un-tilted* as in this position the tag antenna impedance was conjugately matched to the ASIC. The read range is given by [3]:

$$d \leq \lambda/4\pi\sqrt{EIRP \times G_{tag} \times \tau/P_{th}} \quad (1)$$

where $EIRP$ is the effective isotropic radiated power of the reader, G_{tag} is the tag antenna gain, P_{th} is the ASIC circuit activation threshold power. The power transmission coefficient τ between the tag antenna and the transponder ASIC is related to the reflection coefficient Γ . The reflection and power transfer coefficients are referred to the ASIC input impedance by [4]:

$$\tau = 1 - |\Gamma|^2 = 4R_{ic}R_{ant}/|Z_{ic} + Z_{ant}|^2 \quad (2)$$

where Z_{ic} and Z_{ant} are the ASIC and antenna port impedances respectively. R_{ic} and R_{ant} are, in turn, the ASIC and antenna port resistances.

The tag antenna was simulated with various *detuning* line lengths in order to obtain 5-10 MHz difference between the resonance frequencies for each tilt state. The simulated reflection coefficients of the antenna shown in Fig. 3 depict the detuning effect at each state, where for longer *detuning* lines the antenna resonance frequency reduces.

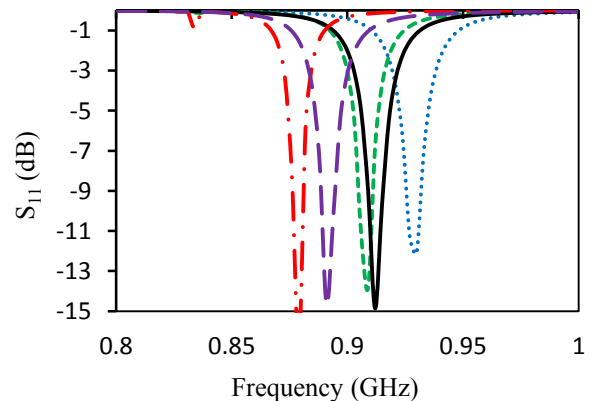

Figure 3: Simulated S_{11} of the tag antenna in *un-tilted* position (solid), Detune line 1 (dotted), Detune line 2 (short-dashed), Detune line 3 (long-dashed) and Detune line 4 (dash-dotted).

4 MEASURED RESULTS

A prototype tag was fabricated (Fig. 4) and observed to function correctly in the *un-tilted*, *tilted left*, *tilted right*, *tilted back* and *tilted forward* states. The read range was measured in a laboratory environment using a Voyantic Tagformance RFID characterization system [5]. This system measures the backscattered powers for tags under test as a function of calibrated transmit power over a fixed transmission distance. The transmit power was used to determine the ASIC activation power P_{th} as a function of frequency. The read range d was extrapolated by the equipment using the Friis transmission equation (1). The system established and automatically subtracted cable and other losses using a benchmark tag with a known response.

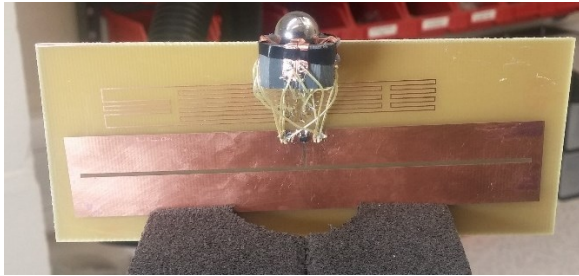

Figure 4, Prototype tilt sensor without encapsulation.

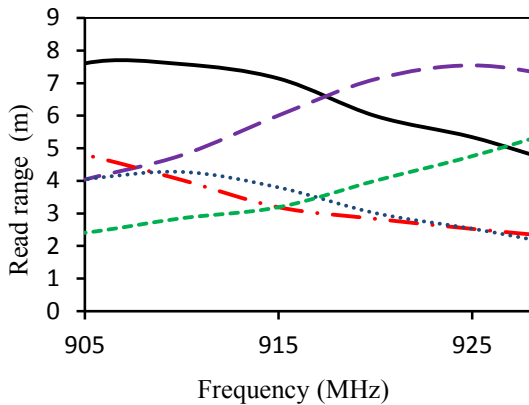

Figure 5: Measured read range in *un-tilted* position (solid), *tilted left* (dotted), *tilted right* (short-dashed), *tilted back* (long-dashed) and *tilted forward* (dash-dotted).

At 910 MHz a maximum read range of 8m was achieved for the *un-tilted* tag and considerably less for all tilt stages as shown in Fig. 5. For a tag position fixed in relation to the interrogation device, the reader is calibrated to record the backscattered power and signal phase at each frequency point for each tilt state. The measured backscattered signal power and phase can then be compared to the calibration curve shown in Figs. 6 and 7 respectively

and related to one of the five tilt states to determine the tilt direction.

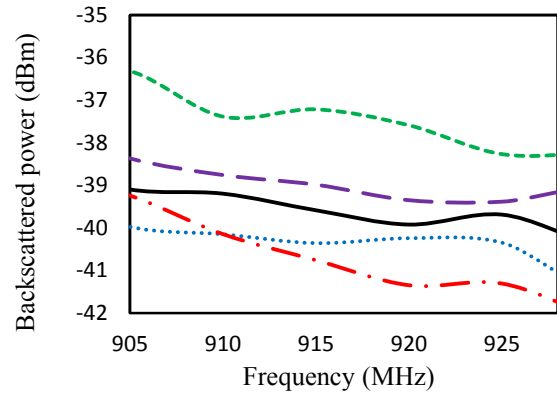

Figure 6: Backscattered power in *un-tilted* state (solid), *tilted left* (dotted), *tilted right* (short-dashed), *tilted back* (long-dashed) and *tilted forward* (dash-dotted).

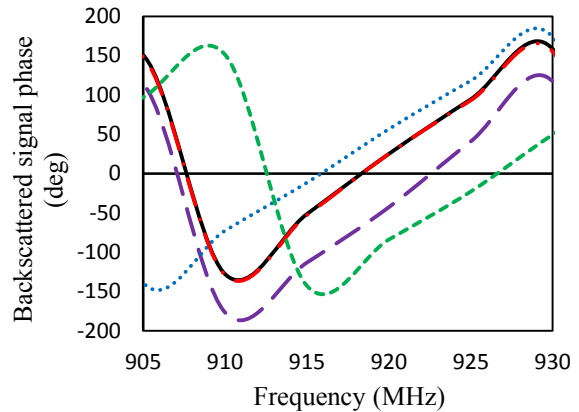

Figure 7: Backscattered signal phase at *un-tilted* state (solid), *tilted left* (dotted), *tilted right* (short-dashed), *tilted back* (long-dashed) and *tilted forward* (dash-dotted).

5 CONCLUSIONS

A platform tolerant smart tag is described to sense the tilt and tilt direction of a tagged object when mounted on a harsh electromagnetic platform such as a good conductor. Read range is demonstrated to long when the tag is in the *un-tilted* position and to become considerably less when the tag is tilted along any of its axes. Measured backscattered signal powers and phases can be compared to calibrated values to determine the direction of the tilt. The tilt angle or the tilt sensitivity of the smart tag is adjustable by altering the position of the switches in the tilt recess element. Avoiding via through connections between the radiating element and the conducting plane in the tag antenna design makes the

proposed smart tag suitable for use in new fabrication processes such as additive manufacture.

References

- [1] BRIDGE, EU FP6 Programme, WP13.
- [2] HSS: helping prevent accidents in storage and warehousing, Western Business Publishing, 01 August 2013.
- [3] K. Finkenzeller, "Physical Principles of RFID Systems," in RFID Handbook: Fundamentals and Applications in Contactless Smart Cards and Identification, 3rd ed., New York: Wiley, 2010, pp. 61-154
- [4] K.V.S. Rao, P.V. Nikitin and S.F. Lam, "Impedance matching concepts in RFID transponder design", in Proc. 4th IEEE Workshop on Automatic Identification Advanced Technologies (AutoID 2005), Buffalo, NY, 2005, pp. 39-42.
- [5] Tagformance. Voyantic LTd. www.voyantic.com/Tagformance.