



# Kent Academic Repository

Cavallaro, Francesca, Clery, Amanda, Gilbert, Ruth, van der Meulen, Jan, Kendall, Sally, Kennedy, Eilis, Phillips, Catherine and Harron, Katie (2024) *Evaluating the real-world implementation of the Family Nurse Partnership in England: a data linkage study*. *Health and social care delivery research*, 12 (11). pp. 1-223. ISSN 2755-0079.

## Downloaded from

<https://kar.kent.ac.uk/106184/> The University of Kent's Academic Repository KAR

## The version of record is available from

<https://doi.org/10.3310/BVDW6447>

## This document version

Publisher pdf

## DOI for this version

## Licence for this version

CC BY (Attribution)

## Additional information

## Versions of research works

### Versions of Record

If this version is the version of record, it is the same as the published version available on the publisher's web site. Cite as the published version.

### Author Accepted Manuscripts

If this document is identified as the Author Accepted Manuscript it is the version after peer review but before type setting, copy editing or publisher branding. Cite as Surname, Initial. (Year) 'Title of article'. To be published in **Title of Journal**, Volume and issue numbers [peer-reviewed accepted version]. Available at: DOI or URL (Accessed: date).

### Enquiries

If you have questions about this document contact [ResearchSupport@kent.ac.uk](mailto:ResearchSupport@kent.ac.uk). Please include the URL of the record in KAR. If you believe that your, or a third party's rights have been compromised through this document please see our [Take Down policy](https://www.kent.ac.uk/guides/kar-the-kent-academic-repository#policies) (available from <https://www.kent.ac.uk/guides/kar-the-kent-academic-repository#policies>).



## Health and Social Care Delivery Research

Volume 12 • Issue 11 • May 2024

ISSN 2755-0079

# Evaluating the real-world implementation of the Family Nurse Partnership in England: a data linkage study

*Francesca Cavallaro, Amanda Clery, Ruth Gilbert, Jan van der Meulen, Sally Kendall,  
Eilis Kennedy, Catherine Phillips and Katie Harron*





# Evaluating the real-world implementation of the Family Nurse Partnership in England: a data linkage study

Francesca Cavallaro<sup>1</sup>, Amanda Clery<sup>1</sup>, Ruth Gilbert<sup>1</sup>,  
Jan van der Meulen<sup>1,2</sup>, Sally Kendall<sup>1,3</sup>, Eilis Kennedy<sup>1,4</sup>,  
Catherine Phillips<sup>1,3</sup> and Katie Harron<sup>1\*</sup>

<sup>1</sup>UCL Great Ormond Street Institute of Child Health, London, UK

<sup>2</sup>London School of Hygiene and Tropical Medicine, London, UK

<sup>3</sup>Centre for Health Services Studies, University of Kent, Canterbury, UK

<sup>4</sup>Eilis Kennedy, Tavistock and Portman NHS Foundation Trust, London, UK

\*Corresponding author

**Disclaimer:** This report contains transcripts of interviews conducted in the course of the research, or similar, and contains language which may offend some readers.

Published May 2024

DOI 10.3310/BVDW6447

This report should be referenced as follows:

Cavallaro F, Clery A, Gilbert R, van der Meulen J, Kendall S, Kennedy E, *et al.* Evaluating the real-world implementation of the Family Nurse Partnership in England: a data linkage study. *Health Soc Care Deliv Res* 2024;**12**(11). <https://doi.org/10.3310/BVDW6447>



# Health and Social Care Delivery Research

ISSN 2755-0079 (Online)

A list of Journals Library editors can be found on the [NIHR Journals Library website](#)

*Health and Social Care Delivery Research* (HSDR) was launched in 2013 and is indexed by Europe PMC, DOAJ, INAHTA, Ulrichsweb™ (ProQuest LLC, Ann Arbor, MI, USA), NCBI Bookshelf, Scopus and MEDLINE.

This journal is a member of and subscribes to the principles of the Committee on Publication Ethics (COPE) ([www.publicationethics.org/](http://www.publicationethics.org/)).

Editorial contact: [journals.library@nhr.ac.uk](mailto:journals.library@nhr.ac.uk)

This journal was previously published as *Health Services and Delivery Research* (Volumes 1–9); ISSN 2050-4349 (print), ISSN 2050-4357 (online)

The full HSDR archive is freely available to view online at [www.journalslibrary.nhr.ac.uk/hsdr](http://www.journalslibrary.nhr.ac.uk/hsdr).

## Criteria for inclusion in the *Health and Social Care Delivery Research* journal

Manuscripts are published in *Health and Social Care Delivery Research* (HSDR) if (1) they have resulted from work for the HSDR programme, and (2) they are of a sufficiently high scientific quality as assessed by the reviewers and editors.

## HSDR programme

The HSDR programme funds research to produce evidence to impact on the quality, accessibility and organisation of health and social care services. This includes evaluations of how the NHS and social care might improve delivery of services.

For more information about the HSDR programme please visit the website at <https://www.nhr.ac.uk/explore-nhr/funding-programmes/health-and-social-care-delivery-research.htm>

## This article

The research reported in this issue of the journal was funded by the HSDR programme or one of its preceding programmes as award number 17/99/19. The contractual start date was in September 2019. The draft manuscript began editorial review in October 2022 and was accepted for publication in February 2023. The authors have been wholly responsible for all data collection, analysis and interpretation, and for writing up their work. The HSDR editors and production house have tried to ensure the accuracy of the authors' manuscript and would like to thank the reviewers for their constructive comments on the draft document. However, they do not accept liability for damages or losses arising from material published in this article.

This article presents independent research funded by the National Institute for Health and Care Research (NIHR). The views and opinions expressed by authors in this publication are those of the authors and do not necessarily reflect those of the NHS, the NIHR, the HSDR programme or the Department of Health and Social Care. If there are verbatim quotations included in this publication the views and opinions expressed by the interviewees are those of the interviewees and do not necessarily reflect those of the authors, those of the NHS, the NIHR, the HSDR programme or the Department of Health and Social Care.

This article was published based on current knowledge at the time and date of publication. NIHR is committed to being inclusive and will continually monitor best practice and guidance in relation to terminology and language to ensure that we remain relevant to our stakeholders.

Copyright © 2024 Cavallaro *et al.* This work was produced by Cavallaro *et al.* under the terms of a commissioning contract issued by the Secretary of State for Health and Social Care. This is an Open Access publication distributed under the terms of the Creative Commons Attribution CC BY 4.0 licence, which permits unrestricted use, distribution, reproduction and adaptation in any medium and for any purpose provided that it is properly attributed. See: <https://creativecommons.org/licenses/by/4.0/>. For attribution the title, original author(s), the publication source – NIHR Journals Library, and the DOI of the publication must be cited.

Published by the NIHR Journals Library ([www.journalslibrary.nhr.ac.uk](http://www.journalslibrary.nhr.ac.uk)), produced by Newgen Digitalworks Pvt Ltd, Chennai, India ([www.newgen.co](http://www.newgen.co)).



# Abstract

## Evaluating the real-world implementation of the Family Nurse Partnership in England: a data linkage study

Francesca Cavallaro<sup>1</sup>, Amanda Clery<sup>1</sup>, Ruth Gilbert<sup>1</sup>,  
Jan van der Meulen<sup>1,2</sup>, Sally Kendall<sup>1,3</sup>, Eilis Kennedy<sup>1,4</sup>,  
Catherine Phillips<sup>1,3</sup> and Katie Harron<sup>1\*</sup>

<sup>1</sup>UCL Great Ormond Street Institute of Child Health, London, UK

<sup>2</sup>London School of Hygiene and Tropical Medicine, London, UK

<sup>3</sup>Centre for Health Services Studies, University of Kent, Canterbury, UK

<sup>4</sup>Eilis Kennedy, Tavistock and Portman NHS Foundation Trust, London, UK

\*Corresponding author [k.harron@ucl.ac.uk](mailto:k.harron@ucl.ac.uk)

**Background/objectives:** The Family Nurse Partnership is an intensive home visiting programme for adolescent mothers. We aimed to evaluate the effectiveness of the Family Nurse Partnership on outcomes up to age 7 using national administrative data.

**Design:** We created a linked cohort of all mothers aged 13–19 using data from health, educational and children's social care and defined mothers enrolled in the Family Nurse Partnership or not using Family Nurse Partnership system data. Propensity scores were used to create matched groups for analysis.

**Setting:** One hundred and thirty-six local authorities in England with active Family Nurse Partnership sites between 2010 and 2017.

**Participants:** Mothers aged 13–19 at last menstrual period with live births between April 2010 and March 2019, living in a Family Nurse Partnership catchment area and their firstborn child(ren).

**Interventions:** The Family Nurse Partnership includes up to 64 home visits by a family nurse from early pregnancy until the child's second birthday and is combined with usual health and social care. Controls received usual health and social care.

**Main outcome measures:** Indicators of child maltreatment (hospital admissions for injury/maltreatment, referral to social care services); child health and development (hospital utilisation and education) outcomes and maternal hospital utilisation and educational outcomes up to 7 years following birth.

**Data sources:** Family Nurse Partnership Information System, Hospital Episode Statistics, National Data Register.

**Results:** Of 110,520 eligible mothers, 25,680 (23.2%) were enrolled in the Family Nurse Partnership. Enrolment rates varied across 122 sites (range: 11–68%). Areas with more eligible mothers had lower enrolment rates. Enrolment was higher among mothers aged 13–15 (52%), than 18–19 year-olds (21%).

Indicators of child maltreatment: we found no evidence of an association between the Family Nurse Partnership and indicators of child maltreatment, except for an increased rate of unplanned admissions for maltreatment/injury-related diagnoses up to age 2 for children born to Family Nurse Partnership mothers (6.6% vs. 5.7%, relative risk 1.15; 95% confidence interval 1.07 to 1.24).

Child health and developmental outcomes: there was weak evidence that children born to Family Nurse Partnership mothers were more likely to achieve a Good Level of Development at age 5 (57.5% vs.



## ABSTRACT

55.4%, relative risk 1.05; 95% confidence interval 1.00 to 1.09). Maternal outcomes: There was some evidence that Family Nurse Partnership mothers were less likely to have a subsequent delivery within 18 months of the index birth (8.4% vs. 9.3%, relative risk 0.92; 95% confidence interval 0.88 to 0.97). Younger and more vulnerable mothers received higher numbers of visits and were more likely to achieve fidelity targets. Meeting the fidelity targets was associated with some outcomes.

**Limitations:** Bias by indication and variation in the intervention and usual care over time and between areas may have limited our ability to detect effects. Multiple testing may have led to spurious, significant results.

**Conclusions:** This study supports findings from evaluations of the Family Nurse Partnership showing no evidence of benefit for maltreatment outcomes measured in administrative data. Amongst all the outcomes measured, we found weak evidence that the Family Nurse Partnership was associated with improvements in child development at school entry, a reduction in rapid repeat pregnancies and evidence of increased healthcare-seeking in the mother and child.

**Future work:** Future evaluations should capture better measures of Family Nurse Partnership interventions and usual care, more information on maternal risk factors and additional outcomes relating to maternal well-being.

**Study registration:** The study is registered as NIHR CRN Portfolio (42900).

**Funding:** This award was funded by the National Institute of Health and Care Research (NIHR) Health and Social Care Delivery Research programme (NIHR award ref: 17/99/19) and is published in full in *Health and Social Care Delivery Research*; Vol. 12, No. 11. See the NIHR Funding and Awards website for further award information.

# Contents

List of tables	xi
List of figures	xvii
List of boxes	xxi
List of abbreviations	xxiii
Plain language summary	xxv
Scientific summary	xxvii
<b>Chapter 1 Background</b>	<b>1</b>
Chapter outline	1
Adolescent pregnancy and adverse outcomes	1
The Family Nurse Partnership and early years health visiting in England	1
Literature review – evidence of effect of Family Nurse Partnership programmes on maternal and child outcomes	3
<i>Review approach</i>	3
<i>USA randomised trials</i>	3
<i>England Building Blocks randomised trial</i>	4
<i>Other randomised trials in Germany, the Netherlands and Canada</i>	4
<i>Non-randomised studies in Australia, Scotland and the USA</i>	5
<i>Other evidence</i>	5
<i>Synthesis</i>	5
Rationale for the present study	6
Research aims and objectives	6
<b>Chapter 2 Methods</b>	<b>7</b>
Chapter outline	7
Study design and participants	7
Data sources	7
<i>Hospital Episode Statistics – Hospital Admissions Data</i>	7
<i>National Pupil Database – education and social care data for mothers enrolled or not in Family Nurse Partnership and their children</i>	8
<i>Family Nurse Partnership information system – Family Nurse Partnership service data for mothers enrolled in Family Nurse Partnership</i>	8
Linkage Family Nurse Partnership-Hospital Episode Statistics	9
<i>Linking mothers enrolled in Family Nurse Partnership to Hospital Episode Statistics</i>	9
<i>Characteristics of unlinked mothers</i>	9
<i>Description of linkage quality</i>	9
Identification of local authorities and enrolment dates for each Family Nurse Partnership site	9
<i>Mothers aged 13–19</i>	9
<i>Mothers aged 20–24</i>	10
Description of Hospital Episode Statistics cohorts	10
<i>Mothers aged 13–19</i>	10

## CONTENTS

Identification of Hospital Episode Statistics child cohort	10
Hospital Episode Statistics – National Pupil Database linkage	11
<i>Description of linkage</i>	11
<i>Characteristics of unlinked mothers and children</i>	11
Definition of outcome variables	12
<i>Indicators of child maltreatment</i>	12
<i>Child health, developmental and educational outcomes</i>	13
<i>Maternal outcomes</i>	13
<i>Follow-up cohorts</i>	15
Definition of exposure variables	16
Analyses	16
<i>Descriptive analyses</i>	16
<i>Enrolment rate and maternal risk factors associated with enrolment in the Family Nurse Partnership (Objective 1)</i>	17
<i>Effect of the Family Nurse Partnership on maternal and child outcomes (Objective 2)</i>	18
<i>Contextual factors associated with benefitting from Family Nurse Partnership (Objective 3)</i>	20
Qualitative analysis	21
Changes from protocol	22
<b>Chapter 3 Results</b>	<b>23</b>
Chapter outline	23
Description of study cohort	23
<i>Description of mothers in study cohort</i>	23
Objective 1 – which groups of adolescent mothers receive Family Nurse Partnership across local authorities?	23
<i>Key messages</i>	23
<i>Enrolment among mothers 13–19</i>	25
<i>Risk factors for enrolment among mothers aged 13–19</i>	25
<i>Stratified analyses according to site enrolment level, English region and year of delivery among mothers 13–19</i>	26
<i>Funnel plots of variation in enrolment rates</i>	29
Objective 2 – what was the effect of Family Nurse Partnership enrolment on maternal and child outcomes?	29
<i>Key messages</i>	29
<i>Descriptive analysis of outcomes of interest according to maternal risk factors</i>	30
<i>Descriptive (unadjusted) analysis of outcomes of interest according to enrolment in Family Nurse Partnership</i>	30
<i>Propensity score matching</i>	30
<i>Subgroup analyses</i>	34
<i>Sensitivity analyses</i>	35
<i>Multivariable regression (adjusted) analyses</i>	35
Objective 3 – which programme and contextual factors influence the effect of Family Nurse Partnership?	35
<i>Key messages</i>	35
<i>Description of attrition, fidelity targets and dosage in the Family Nurse Partnership</i>	37
<i>Participant, programme and nurse characteristics associated with dosage in the Family Nurse Partnership</i>	43
<i>Effect of programme and contextual factors and dosage on outcomes</i>	45
<b>Chapter 4 Discussion and implications of evaluation findings</b>	<b>49</b>
Chapter outline	49

Objective 1 – which groups of adolescent mothers receive Family Nurse Partnership across local authorities?	49
<i>Summary of main results</i>	49
<i>Comparison with existing evidence</i>	49
<i>Interpretation</i>	50
Objective 2 – what is the effect of Family Nurse Partnership enrolment on maternal and child outcomes?	51
<i>Summary of main results</i>	51
<i>Comparison with existing evidence</i>	52
<i>Interpretation</i>	54
Objective 3 – what contextual and programme factors influence the effect of Family Nurse Partnership?	56
<i>Summary of main results and comparison with previous evidence</i>	56
<i>Interpretation</i>	57
Strengths and limitations	57
<i>Strengths</i>	57
<i>Limitations</i>	58
Patient and public involvement	61
Equality, diversity and inclusion	62
Conclusions	62
Implications for policy and practice	64
<i>Delivering interventions to high-risk families</i>	64
<i>Improving data to support quasi-experimental research studies</i>	64
Recommendations for research	65
<i>Development of the intervention</i>	65
<i>Improvement of delivery, including targeting</i>	65
<i>Measuring the right outcomes</i>	66
<i>Design of future studies</i>	66
<b>Additional information</b>	<b>67</b>
<b>References</b>	<b>71</b>
<b>Appendix 1</b> Summary of literature review of effectiveness of Family Nurse Partnership on birth, child and maternal outcomes	<b>83</b>
<b>Appendix 2</b> Additional information on creating the linked cohort	<b>89</b>
<b>Appendix 3</b> International Classification of Diseases, 10th Revision code lists	<b>107</b>
<b>Appendix 4</b> Additional information on methods for Objective 3	<b>117</b>
<b>Appendix 5</b> Additional information on results for Objective 1: enrolment in the Family Nurse Partnership	<b>121</b>
<b>Appendix 6</b> Maternal and child outcomes according to maternal risk factors at enrolment or 20 weeks of pregnancy	<b>173</b>
<b>Appendix 7</b> Additional information on Objective 2: propensity score generation and matching	<b>191</b>

## CONTENTS

<b>Appendix 8</b> Additional information on Objective 2	<b>195</b>
<b>Appendix 9</b> Additional information on Objective 2: sensitivity analyses	<b>203</b>
<b>Appendix 10</b> Additional results for Objective 3	<b>213</b>
<b>Appendix 11</b> Timeline for data access	<b>223</b>

## List of tables

<b>TABLE 1</b> Family Nurse Partnership outcomes and data sources	15
<b>TABLE 2</b> Numbers of mothers aged 13–19 and 20–24 and their children, with follow-up at birth, 2 and 7 years, in the main analysis comparing mothers who were enrolled in the FNP with mothers living in areas in which FNP was offered at the time of pregnancy	16
<b>TABLE 3</b> Maternal risk factors prior to enrolment (FNP participants) or antenatal booking appointment (controls)	17
<b>TABLE 4</b> Fidelity targets: number of completed visits expected at each phase of the programme	21
<b>TABLE 5</b> Selected characteristics of mothers aged 13–19 ever enrolled or not in the FNP	24
<b>TABLE 6</b> Risk factors for FNP enrolment among mothers aged 13–19 at LMP, living in a LA with an active FNP site at the time of first antenatal appointment (England, births between April 2010 and March 2017)	27
<b>TABLE 7</b> Description of indicators of child maltreatment among study cohort of first-time mothers 13–19 giving birth between April 2010 and March 2019	31
<b>TABLE 8</b> Description of selected child health, developmental and educational outcomes among study cohort of first-time mothers aged 13–19	31
<b>TABLE 9</b> Description of maternal outcomes among study cohort of first-time mothers aged 13–19	33
<b>TABLE 10</b> Relative risks and 95% CIs for indicators of child maltreatment comparing mothers enrolled in the FNP vs. mothers who were not enrolled, for mothers aged 13–19 in the propensity-score-matched cohort	37
<b>TABLE 11</b> Relative risks and 95% CIs for health, developmental and educational outcomes comparing mothers enrolled in the FNP vs. mothers who were not enrolled, for mothers aged 13–19 in the propensity-score-matched cohort	38
<b>TABLE 12</b> Relative risks and 95% CIs for maternal outcomes comparing mothers enrolled in the FNP vs. mothers who were not enrolled, for mothers aged 13–19 in the propensity-score-matched cohort	39
<b>TABLE 13</b> Summary of time and visit targets in each stage of the FNP programme for mothers with births between April 2010 and January 2018 aged 13–19 at LMP	43
<b>TABLE 14</b> Pregnancy targets: maternal, programme and area-level characteristics associated with meeting fidelity targets in pregnancy, for mothers giving birth between April 2010 and January 2018 aged 13–19 at LMP	45

<b>TABLE 15</b> Infancy targets: maternal, programme and area-level characteristics associated with meeting fidelity targets in infancy, for mothers giving birth between April 2010 and January 2018 aged 13–19 at LMP	<b>46</b>
<b>TABLE 16</b> Toddlerhood targets: maternal, programme and area-level characteristics associated with meeting fidelity targets in toddlerhood, for mothers giving birth between April 2010 and January 2018 aged 13–19 at LMP	<b>47</b>
<b>TABLE 17</b> Adjusted RRs and 95% CIs comparing outcomes for mothers who achieved fidelity targets at each stage of the programme with those who did not achieve the fidelity targets in that stage, for births between April 2010 and January 2018 to mothers aged 13–19 at LMP	<b>48</b>
<b>TABLE 18</b> Potential sources of bias in the evaluations of the Family Nurse Partnership in England using linked administrative data and information needed to assess their likely extent	<b>58</b>
<b>TABLE 19</b> Effectiveness of FNP on birth and child outcomes – summary of the literature	<b>84</b>
<b>TABLE 20</b> Effectiveness of FNP on maternal outcomes – summary of the literature	<b>87</b>
<b>TABLE 21</b> Algorithm used to link FNP cohort members (mothers and children) with missing NHS number to the NHS Personal Demographic Service in order to obtain an NHS number prior to linkage with HES	<b>92</b>
<b>TABLE 22</b> Algorithm used to link all FNP cohort members (mothers and children) to HES, following retrieval of missing NHS numbers via the Personal Demographic Service	<b>92</b>
<b>TABLE 23</b> Percentage of records with missing valid identifiers for linkage among mothers recorded in the FNP IS from 2010 to 2019	<b>92</b>
<b>TABLE 24</b> Characteristics of FNP mothers who did and did not link to a HESID	<b>93</b>
<b>TABLE 25</b> Agreement between information recorded in FNP IS and HES for mothers who linked to a HESID APC record	<b>95</b>
<b>TABLE 26</b> Family Nurse Partnership site enrolment activity dates between April 2010 and March 2019 (mothers aged 13–19)	<b>97</b>
<b>TABLE 27</b> Family Nurse Partnership site enrolment activity dates between April 2010 and March 2019 (mothers aged 20–24)	<b>102</b>
<b>TABLE 28</b> Algorithm used to link mothers and babies in the study cohort to NPD	<b>102</b>
<b>TABLE 29</b> Characteristics of mothers in cohort who linked and did not link to NPD	<b>103</b>
<b>TABLE 30</b> Characteristics of FNP mothers in cohort who linked and did not link to NPD (from information recorded in FNP IS)	<b>104</b>
<b>TABLE 31</b> Characteristics of children in cohort who linked and did not link to NPD	<b>105</b>

<b>TABLE 32</b> Numbers of mothers enrolled in each FNP site, for first-time mothers aged 13–19 at LMP by FNP site – births between April 2010 and March 2017	<b>121</b>
<b>TABLE 33</b> Characteristics of mothers aged 13–19 at LMP, ever enrolled in the FNP (information from the FNP IS)	<b>128</b>
<b>TABLE 34</b> Characteristics of mothers aged 13–19 ever enrolled and never enrolled in the FNP (information from HES and NPD)	<b>129</b>
<b>TABLE 35</b> Characteristics of mothers aged 20–24 ever enrolled and never enrolled in the FNP (information from HES and NPD)	<b>132</b>
<b>TABLE 36</b> Comparison of maternal risk factors among eligible mothers aged 13–19 living in an area with an active FNP site at the time of first antenatal appointment and those living in an area where FNP was never commissioned, births between March 2010 and April 2017	<b>133</b>
<b>TABLE 37</b> Distribution of FNP sites, first-time adolescent mothers enrolled in FNP, eligible mothers and median and maximum caseloads by quartile of enrolment rates, births between March 2010 and April 2017	<b>135</b>
<b>TABLE 38</b> Risk factors for enrolment in the FNP in high- and low-enrolment sites, among mothers aged 13–19 at LMP, living in a LA with an active FNP site at the time of first antenatal appointment – England, births April 2010–March 2017	<b>135</b>
<b>TABLE 39</b> Predictors of enrolment in the FNP by English region, among mothers aged 13–19 at LMP, living in a LA with an active FNP site at the time of first antenatal appointment – England, births between April 2010 and March 2017	<b>140</b>
<b>TABLE 40</b> Predictors of enrolment in the FNP by financial year, among mothers aged 13–19 at LMP, living in a LA with an active FNP site at the time of first antenatal appointment – England, births between April 2010 and March 2017	<b>159</b>
<b>TABLE 41</b> Predictors of FNP enrolment among mothers aged 20–24 at LMP, living in a LA with an active FNP site at the time of first antenatal appointment, giving birth between November 2016 and March 2019	<b>170</b>
<b>TABLE 42</b> Indicators of child maltreatment among study cohort of first-time mothers aged 13–19 according to risk factors at enrolment or 20 weeks of pregnancy	<b>174</b>
<b>TABLE 43</b> Child health outcomes up to 2 years among study cohort of first-time mothers aged 13–19 according to risk factors at enrolment or 20 weeks of pregnancy	<b>177</b>
<b>TABLE 44</b> Child education outcomes up to age 7 among study cohort of first-time mothers aged 13–19 according to risk factors at enrolment or 20 weeks of pregnancy	<b>180</b>
<b>TABLE 45</b> Child development outcomes up to age 7 among study cohort of first-time mothers aged 13–19 according to risk factors at enrolment or 20 weeks of pregnancy	<b>183</b>
<b>TABLE 46</b> Child health outcomes up to 7 years among study cohort of first-time mothers aged 13–19 according to risk factors at enrolment or 20 weeks of pregnancy	<b>186</b>



<b>TABLE 47</b> Maternal health outcomes among study cohort of first-time mothers aged 13–19 according to risk factors at enrolment or 20 weeks of pregnancy	<b>188</b>
<b>TABLE 48</b> Balance of maternal risk factors in the propensity-score-matched cohort of all mothers aged 13–19 giving birth between April 2010 and March 2019	<b>192</b>
<b>TABLE 49</b> Description of all child health, developmental and educational outcomes among study cohort of first-time mothers aged 13–19	<b>196</b>
<b>TABLE 50</b> Relative risks and 95% CIs for domains of a Good Level of Development (school readiness) comparing mothers enrolled in the FNP vs. mothers who were not enrolled, for mothers aged 13–19 in the propensity-score-matched cohort	<b>197</b>
<b>TABLE 51</b> Subgroup analysis: RRs comparing outcomes for mothers enrolled in the FNP vs. mothers who were never enrolled in the FNP, living within an area in which FNP was offered at the time of pregnancy, within each subgroup	<b>200</b>
<b>TABLE 52</b> Sensitivity analyses: RRs and 95% CIs for indicators of child maltreatment comparing mothers enrolled in the FNP vs. mothers who were not enrolled, for mothers aged 13–19 in the propensity-score-matched cohort	<b>206</b>
<b>TABLE 53</b> Sensitivity analyses: RRs and 95% CIs for child health, developmental and education outcomes comparing mothers enrolled in the FNP vs. mothers who were not enrolled, for mothers aged 13–19 in the propensity-score-matched cohort	<b>207</b>
<b>TABLE 54</b> Sensitivity analyses: RRs and 95% CIs for maternal outcomes comparing mothers enrolled in the FNP vs. mothers who were not enrolled, for mothers aged 13–19 in the propensity-score-matched cohort	<b>208</b>
<b>TABLE 55</b> Sensitivity analyses of modelling approaches: RRs comparing Indicators of child maltreatment for mothers enrolled in the FNP vs. mothers who were never enrolled in the FNP, living within an area in which FNP was offered at the time of pregnancy	<b>209</b>
<b>TABLE 56</b> Sensitivity analyses of modelling approaches: RRs comparing child health, developmental and educational outcomes for mothers enrolled in the FNP vs. mothers who were never enrolled in the FNP, living within an area in which FNP was offered at the time of pregnancy	<b>210</b>
<b>TABLE 57</b> Sensitivity analyses of modelling approaches: RRs maternal outcomes for mothers enrolled in the FNP vs. mothers who were never enrolled in the FNP, living within an area in which FNP was offered at the time of pregnancy	<b>211</b>
<b>TABLE 58</b> Maternal characteristics and number of visits and fidelity targets at each stage of the programme, for mothers giving birth between April 2010 and January 2018 aged 13–19 at LMP, according to HES and NPD data at enrolment	<b>213</b>
<b>TABLE 59</b> Nurse and participant characteristics and number of visits and fidelity targets at each stage of the programme, for mothers giving birth between April 2010 and January 2018 aged 13–19 at LMP, according to FNP information at enrolment	<b>217</b>

<b>TABLE 60</b> Pregnancy targets: year of delivery and fidelity targets in pregnancy, for mothers giving birth between April 2010 and January 2018 aged 13–19 at LMP	<b>220</b>
<b>TABLE 61</b> Infancy targets: year of delivery and fidelity targets in infancy, for mothers giving birth between April 2010 and January 2018 aged 13–19 at LMP	<b>221</b>
<b>TABLE 62</b> Toddlerhood targets: year and season of delivery and fidelity targets in toddlerhood, for mothers giving birth between April 2010 and January 2018 aged 13–19 at LMP	<b>222</b>



# List of figures

<b>FIGURE 1</b> Family Nurse Partnership site activity status in March 2019 among all FNP sites active during the study period (2010–9), by English LA	2
<b>FIGURE 2</b> Identification of FNP participants and comparison group among cohort of mothers aged 13–19	11
<b>FIGURE 3</b> Description of linkage of the NPD and HES – mothers in cohort	12
<b>FIGURE 4</b> Description of linkage of the NPD to HES – children in cohort	12
<b>FIGURE 5</b> Family Nurse Partnership evaluation – data sources and outcomes	14
<b>FIGURE 6</b> Percentage enrolment in the FNP among eligible mothers aged 13–19, living in a LA with an active FNP site at the time of first antenatal appointment, by LA – England, births between 1 April 2010 and 31 March 2017	26
<b>FIGURE 7</b> Unadjusted funnel plots of variation in FNP enrolment rates among eligible first-time mothers aged 13–19 across FNP sites, by maternal age, births between April 2010 and March 2017	29
<b>FIGURE 8</b> Indicators of child maltreatment: adjusted RRs and 95% CIs comparing outcomes for mothers enrolled in the FNP vs. mothers who were not enrolled, for mothers aged 13–19 and giving birth in an area in which FNP was offered at the time of pregnancy	35
<b>FIGURE 9</b> Child health, developmental and educational outcomes: adjusted RRs and 95% CIs comparing mothers enrolled in the FNP vs. mothers who were not enrolled, for mothers aged 13–19 and giving birth in an area in which FNP was offered at the time of pregnancy	36
<b>FIGURE 10</b> Maternal outcomes: adjusted RRs and 95% CIs comparing outcomes for mothers enrolled in the FNP vs. mothers who were not enrolled, for mothers aged 13–19 and giving birth in an area in which FNP was offered at the time of pregnancy	36
<b>FIGURE 11</b> Child unplanned admissions for maltreatment/injury in the 2 years following birth: subgroup analysis presenting adjusted RRs and 95% CIs comparing mothers enrolled in the FNP vs. mothers who were not enrolled, for mothers aged 13–19 and giving birth in an area in which FNP was offered at the time of pregnancy	40
<b>FIGURE 12</b> Good level of development: subgroup analysis presenting adjusted RRs and 95% CIs comparing mothers enrolled in the FNP vs. mothers who were not enrolled, for mothers aged 13–19 and giving birth in an area in which FNP was offered at the time of pregnancy	41
<b>FIGURE 13</b> Subsequent delivery within 18 months: subgroup analysis presenting adjusted RRs and 95% CIs comparing mothers enrolled in the FNP vs. mothers who were not enrolled, for mothers aged 13–19 and giving birth in an area in which FNP was offered at the time of pregnancy	41

<b>FIGURE 14</b> Maternal unplanned admissions for any diagnosis in the 2 years following delivery: subgroup analysis presenting adjusted RRs and 95% CIs comparing mothers enrolled in the FNP vs. mothers who were not enrolled, for mothers aged 13–19 and giving birth in an area in which FNP was offered at the time of pregnancy	42
<b>FIGURE 15</b> Percentage of mothers meeting fidelity targets for the number of expected visits in pregnancy, infancy and toddlerhood, according to FNP site, for births between April 2010 and January 2018 to mothers aged 13–19 at LMP	44
<b>FIGURE 16</b> Time periods and ages of cohort members included in the study	90
<b>FIGURE 17</b> Description of FNP cohort and linkage to HES	91
<b>FIGURE 18</b> Identification of FNP participants and comparison group among cohort of mothers aged 20–24	96
<b>FIGURE 19</b> Linkage of mothers in study cohort to their first child(ren)	97
<b>FIGURE 20</b> Flow of participants through the full FNP programme, from enrolment to completion	118
<b>FIGURE 21</b> Flow of participants through the pregnancy stage of the programme	118
<b>FIGURE 22</b> Flow of participants through the infancy stage of the programme	119
<b>FIGURE 23</b> Flow of participants through the toddlerhood stage of the programme	119
<b>FIGURE 24</b> Adjusted ORs and 95% CIs comparing FNP enrolment by maternal age, stratified by region	169
<b>FIGURE 25</b> Adjusted ORs and 95% CIs comparing FNP enrolment by ethnic group, stratified by region	169
<b>FIGURE 26</b> Adjusted ORs and 95% CIs comparing FNP enrolment by area-level deprivation (quintile of IMD), stratified by region	170
<b>FIGURE 27</b> Adjusted funnel plots of variation in FNP enrolment among eligible first-time adolescent mothers across FNP sites, by maternal age at birth	172
<b>FIGURE 28</b> Overlap in the distribution of propensity scores between mothers who were and were not enrolled in FNP	191
<b>FIGURE 29</b> Propensity scores for all FNP mothers and those included in the matched cohort for analysis	191
<b>FIGURE 30</b> Standardised differences comparing maternal risk factors in the propensity-score-matched cohort of all mothers aged 13–19 giving birth between April 2010 and March 2019	192
<b>FIGURE 31</b> Subgroup analysis: child unplanned admissions for maltreatment/injury up to age 2: adjusted RRs and 95% CIs comparing mothers enrolled in the FNP vs. mothers who were not enrolled, for mothers aged 13–19 and giving birth in an area in which FNP was offered at the time of pregnancy by region and year of delivery	198

<b>FIGURE 32</b> Subgroup analysis: Good Level of Development (school readiness): adjusted RRs and 95% CIs comparing mothers enrolled in the FNP vs. mothers who were not enrolled, for mothers aged 13–19 and giving birth in an area in which FNP was offered at the time of pregnancy by region and year of delivery	<b>198</b>
<b>FIGURE 33</b> Subgroup analysis: subsequent births within 18 months: adjusted RRs and 95% CIs comparing mothers enrolled in the FNP vs. mothers who were not enrolled, for mothers aged 13–19 and giving birth in an area in which FNP was offered at the time of pregnancy by region and year of delivery	<b>199</b>
<b>FIGURE 34</b> Subgroup analysis: maternal unplanned admissions for any diagnosis in the 2 years following delivery: adjusted RRs and 95% CIs comparing mothers enrolled in the FNP vs. mothers who were not enrolled, for mothers aged 13–19 and giving birth in an area in which FNP was offered at the time of pregnancy by region and year of delivery	<b>199</b>
<b>FIGURE 35</b> Sensitivity analysis 1: overlap in the distribution of propensity scores between mothers who were and were not enrolled in FNP (top figure); propensity scores for all FNP mothers and those included in the matched without replacement cohort for analysis (bottom figure)	<b>203</b>
<b>FIGURE 36</b> Sensitivity analysis 2: overlap in the distribution of propensity scores between mothers who were and were not enrolled in FNP (top figure); propensity scores for all FNP mothers and those included in the matched without replacement cohort for analysis (bottom figure)	<b>204</b>
<b>FIGURE 37</b> Sensitivity analyses: RRs and 95% CIs for indicators of child maltreatment comparing mothers enrolled in the FNP vs. mothers who were not enrolled, for mothers aged 13–19 in the propensity-score-matched cohort	<b>205</b>
<b>FIGURE 38</b> Sensitivity analyses: RRs and 95% CIs for child health, developmental and education outcomes comparing mothers enrolled in the FNP vs. mothers who were not enrolled, for mothers aged 13–19 in the propensity-score-matched cohort	<b>205</b>
<b>FIGURE 39</b> Sensitivity analyses: RRs and 95% CIs for maternal outcomes comparing mothers enrolled in the FNP vs. mothers who were not enrolled, for mothers aged 13–19 in the propensity-score-matched cohort	<b>206</b>
<b>FIGURE 40</b> Distribution of visits for each stage of the programme, for mothers giving birth between April 2010 and January 2018 aged 13–19 at LMP	<b>213</b>



## List of boxes

<b>BOX 1</b> Findings from qualitative analysis on the themes of ‘Persistence’, ‘Acceptance’ and ‘Dedication’	<b>51</b>
<b>BOX 2</b> Findings from qualitative analysis on the themes of ‘Time’	<b>57</b>
<b>BOX 3</b> Findings from qualitative analysis on the themes of ‘Progress’, ‘Lack of understanding’, ‘Value’ and ‘Holistic approach’	<b>63</b>





## List of abbreviations

A&E	accident and emergency	ICD-10	International Classification of Diseases, 10th Revision
APC	admitted patient care		
CiN	Child in Need	IDACI	Income Deprivation Affecting Children Index
CLA	Child Looked After		
CPP	child protection plan	IMD	Index of Multiple Deprivation
DfE	Department for Education	IQ	intelligence quotient
EYFSP	early years foundation stage profile	LA	local authority
FNP	Family Nurse Partnership	LMP	last menstrual period
FNP IS	Family Nurse Partnership information system	NFP	Nurse Family Partnership
FSM	free school meals	NPD	National Pupil Database
GCSE	General Certificate of Secondary Education	ONS	Office for National Statistics
GP	general practitioner	OPCS-4	Office of Population, Censuses and Surveys Classification of Surgical Operations and Procedures, version 4
HES	Hospital Episode Statistics	PPI	patient and public involvement
HESID	Hospital Episode Statistics Identifier	PRU	Pupil Referral Unit
		SEN	Special Educational Needs
		UPN	Unique Pupil Number



## Plain language summary

The Family Nurse Partnership is an intensive home visiting service that offers first-time young mothers up to 64 visits with a family nurse from pregnancy to their child's second birthday. The Family Nurse Partnership aims to improve birth outcomes, child health and development and promote economic self-sufficiency among young mothers. Previous research in England found no differences in birthweight, maternal smoking, repeat pregnancies or accident and emergency attendances between mothers who did or did not take part in the Family Nurse Partnership. However, children in the Family Nurse Partnership group had better measures of development at school age.

We aimed to add to the evidence from earlier studies, by using electronic records that are routinely collected as part of health, education and social care services, to compare outcomes for around 26,000 mothers enrolled in the Family Nurse Partnership between 2010 and 2019 with similar mothers who were not enrolled.

This study showed that around one in four mothers who were eligible for the programme were enrolled in the Family Nurse Partnership, and family nurses gave priority to mothers who were younger, more deprived or who had other markers of vulnerability (e.g. a history of substance misuse, violence, self-harm or mental health conditions). We found no evidence of a difference in indicators of child maltreatment between mothers who were enrolled in the Family Nurse Partnership and those who were not enrolled, but we found weak evidence to suggest that children born to mothers enrolled in the Family Nurse Partnership were more likely to achieve a Good Level of Development at school entry (age 5). We also saw that mothers enrolled in the Family Nurse Partnership were less likely than those who were not enrolled to have their next child within 18 months of their first child.

More research is needed to understand which elements of intensive home visiting services work best, for whom and when. This will help inform decisions about whether it is better to offer highly intensive services for a small portion of the target population or to extend and enhance existing universal health visiting services to better support all adolescent mothers.



# Scientific summary

## Background

The Family Nurse Partnership (FNP) is an intensive home visiting programme supporting young first-time mothers, which has a strong evidence base from several randomised trials in the USA. Mothers enrolled in the FNP receive up to 64 home visits by a dedicated family nurse, from early pregnancy until the child's second birthday. The FNP aims to improve birth outcomes, child health and development and promote economic self-sufficiency among young mothers. Although a randomised trial of the FNP in England found no evidence of benefit on smoking in pregnancy, birthweight, hospital admissions before age 2 or second pregnancy within 2 years, improved cognitive development outcomes were reported, and there remains strong support for the programme locally.

Our population-based study used longitudinal linked observational data between the health, education and social care sectors to evaluate the effects of FNP on outcomes of eligible mothers and their children up to age 7 and generated evidence on the factors that may influence effectiveness and programme engagement (including participant and programme characteristics). We aimed to generate evidence on which groups of mothers and children benefit from the real-world implementation of FNP in England in order to inform the targeting and commissioning of services.

## Objectives

1. Determine the rate of and characteristics associated with enrolment in FNP among young mothers across local authorities in England.
2. Determine the effect of FNP on maternal and child outcomes, including identifying which families benefit the most from FNP.
3. Identify contextual and programme factors that might influence the effect of FNP.

## Methods

We created a linked cohort of all mothers aged 13–19 using data from health, educational and children's social care and defined mothers enrolled in FNP or not using FNP system data. Propensity scores based on pre-enrolment maternal characteristics were used to create matched groups for analysis.

## Setting

One hundred and thirty-six local authorities in England with active FNP sites between 2010 and 2019.

## Participants

Mothers aged 13–19 at last menstrual period with their first live birth between April 2010 and March 2019, living in a FNP catchment area and their firstborn child(ren).

## Interventions

The FNP includes up to 64 home visits by a family nurse from early pregnancy until the child's second birthday and is combined with usual health and social care. Controls received usual health and social care alone.

## Main outcome measures

Indicators of child maltreatment (hospital admissions for injury/maltreatment, referral to social care services); child health and development (hospital utilisation and education) outcomes and maternal hospital utilisation and educational outcomes up to 7 years following birth.

## Data sources

Family Nurse Partnership Information System data on programme participation linked with hospital admissions, outpatient referrals/attendances and accident and emergency (A&E) attendances from Hospital Episode Statistics and information on pupils attending state schools or children in contact with social care services in England from the National Pupil Database.

## Results

### Objective 1

Of 110,520 eligible mothers aged 13–19 years who gave birth between April 2010 and March 2017, 25,680 (23.2%) were enrolled in FNP: 14% were aged 13–15 years. Enrolment rates varied across 122 sites (range: 11–68%). Areas with more eligible mothers had lower enrolment rates. Enrolment was higher among mothers aged 13–15 (52%) than 18–19 year-olds (21%). Only 26% of mothers with markers of vulnerability (including living in the most deprived area decile or previous mental health-related hospitalisations) were enrolled.

### Objective 2

Indicators of child maltreatment: we found no evidence of an association between FNP and indicators of child maltreatment, except for an increased rate of unplanned admissions for maltreatment/injury-related diagnoses up to age 2 for children born to mothers enrolled in FNP [6.6% vs. 5.7%, relative risk (RR) 1.15; 95% confidence interval (CI) 1.07 to 1.24] and weak evidence of a reduction in the percentage of children with a child protection plan for those born to mothers enrolled in FNP (5.1% vs. 6.1%, RR 0.84; 95% CI 0.71 to 1.00).

Child health and developmental outcomes: FNP was associated with an increase in the number of children with  $\geq 1$  unplanned admission for any diagnosis up to age 2 and the number of children with  $\geq 1$  A&E attendance by age 2 and age 7. There was weak evidence that children born to FNP mothers were more likely to achieve a Good Level of Development (school readiness) at age 5 (57.5% vs. 55.4%, RR 1.05; 95% CI 1.00 to 1.09). There was no evidence of a difference between groups in Special Educational Needs provision or attainment at Key Stage 1, but FNP was associated with an increase in the percentage of children registered for Free School Meals (51.2% vs. 46.7%, RR 1.09; 95% CI 1.04 to 1.14).

## Maternal outcomes

Mothers enrolled in FNP were more likely to have unplanned hospital admissions for any diagnosis (and for adversity and mental health diagnoses) in the 2 years following birth, compared with mothers who were not enrolled. This effect persisted until 7 years following birth, though the size of the effect

decreased over time. Mothers enrolled in FNP were less likely to have a subsequent delivery within 18 months of the index birth (8.4% vs. 9.3%, RR 0.92; 95% CI 0.88 to 0.97) compared to those who were not enrolled.

### **Objective 3**

Fifty-eight per cent of mothers enrolled in FNP completed the programme (42% left early). Attrition was 8% during pregnancy, 23% in infancy (between birth and 1 year) and 19% in toddlerhood (between 1 and 2 years). Mothers received on average 38 visits and 42 hours of contact time with family nurses during the programme. Younger and more vulnerable mothers received higher numbers of visits and were more likely to achieve fidelity targets for the expected number of visits at each stage of the programme. After adjusting for these characteristics, mothers who met the target for the number of expected visits in pregnancy were less likely to have a subsequent birth within 18 months than those who did not meet the target; children born to mothers who met the target in infancy and toddlerhood were more likely to have an unplanned hospital admission for maltreatment/injury up to age 2 than those who did not meet the targets in these stages.

## **Conclusions**

Our findings support previous evaluations of FNP in England, which show no evidence of an impact on child maltreatment outcomes but some weak evidence that FNP is associated with improvements in some child development measures.

### **Limitations**

Mothers enrolled in FNP were more vulnerable than those who were not, but we could only control for maternal characteristics associated with enrolment that were captured in administrative data. Residual confounding could have limited our ability to detect beneficial effects of the programme. The weak evidence for small improvements in school readiness as measured by a Good Level of Development, and reductions in the number of rapid repeat pregnancies may therefore reflect larger positive effects of the programme. As these outcomes were the only 'positive' effects amongst the many outcomes that were evaluated, they could be due to chance.

There are challenges in interpreting outcomes captured in administrative data: the increased rates of unplanned admissions and A&E attendances in the mother and child associated with FNP may reflect higher rates of health problems or appropriate care seeking when a health problem such as injury occurs as a result of advice and support from family nurses. This finding could therefore be interpreted as demonstrating that family nurses can have a long-term effect on maternal health care-seeking behaviours.

This study was not designed to identify effects on a range of other important outcomes, including changes in self-reported maternal mental health, well-being, confidence, behaviour and mother/parent-child engagement and interaction.

### **Implications**

Despite reductions in teenage pregnancies over recent decades, there remains a significant population of young and vulnerable mothers in England who need intensive support. Currently, the majority of these mothers are not receiving support from FNP, as it is not offered in all areas and is only offered to around one in four mothers in areas in which it is commissioned. Expecting to detect effects of home visiting that starts in pregnancy on birth outcomes and on relatively insensitive child development measures and other child outcomes may be unreasonable in the context of social disadvantage, discrimination and other challenges that adolescent mothers face before, during and after pregnancy. However, there is strong support for FNP locally, and FNP practitioners report that mothers participating in the programme develop more reflective parenting and awareness of their child's needs.



Without better evidence, removing support for young mothers could be harmful, especially in the context of increasing social disadvantage and widespread health visitor shortages. There remains uncertainty about whether it is better to commission highly intensive services like the FNP versus enhanced universal services.

### **Recommendations for research**

More research is needed to understand which elements of intensive interventions are most effective, for whom and when and to help inform decisions about whether it is better to commission highly intensive services for a small portion of the target population or to extend and enhance universal services to better support all adolescent mothers.

More research is needed to understand the effects of the programme on mothers who are not enrolled in FNP: we do not yet know if FNP diverts resources away from the usual care that an adolescent mother should receive or if FNP has a positive effect on mothers not enrolled in the programme through shared learning and practices.

Robust evaluation is needed of modifications to FNP, including changes in the Accelerated Design and Programme Testing sites, outcomes for mothers aged 20–24 years, outcomes for fathers and outcomes for subsequent children.

Better measures of changes in maternally reported well-being, confidence, mental health, parent–child interaction and child behaviour would improve evidence on whether the programme affects mothers and their children and how.

### **Study registration**

The study is registered as NIHR CRN Portfolio (42900).

### **Funding**

This award was funded by the National Institute of Health and Care Research (NIHR) Health and Social Care Delivery Research programme (NIHR award ref: 17/99/19) and is published in full in *Health and Social Care Delivery Research*; Vol. 12, No. 11. See the NIHR Funding and Awards website for further award information.

# Chapter 1 Background

Parts of this chapter have been reproduced from the published papers by Cavallaro *et al.*<sup>1</sup> and Cavallaro *et al.*<sup>2</sup> These are open-access articles distributed in accordance with the Creative Commons Attribution 4.0 Unported (CC BY 4.0) licence, which permits others to copy, redistribute, remix, transform and build upon this work for any purpose, provided the original work is properly cited, a link to the licence is given and an indication of whether changes were made. See: <http://creativecommons.org/licenses/by/4.0/>.

## Chapter outline

This chapter describes the context of adolescent pregnancy and the health visiting services available in England. It briefly describes the implementation of the Family Nurse Partnership (FNP) in England and reviews the literature on its effectiveness. It concludes with a description of the rationale for the present study and study objectives.

## Adolescent pregnancy and adverse outcomes

Each year, approximately 3% of babies (~16,000 in 2020) are born to mothers aged < 20 years in England and Wales.<sup>3</sup> Adolescent mothers are more likely to experience adversity, be less engaged with education and employment and have rapid repeat pregnancies compared with older mothers.<sup>4-7</sup> For their children, young maternal age is associated with a higher incidence of preterm birth, low birthweight<sup>8,9</sup> and a greater risk of child maltreatment and associated adverse long-term consequences, including poorer physical health and social, emotional and cognitive outcomes.<sup>10-12</sup> These adverse maternal and child outcomes of adolescent pregnancy, due to social adversity, disruption to education and employment and child-rearing practices, are of major importance to public health research and the NHS.<sup>13,14</sup> Programmes supporting adolescent mothers, such as the FNP, are therefore likely to remain a priority for the NHS and local authorities (LAs).<sup>15</sup>

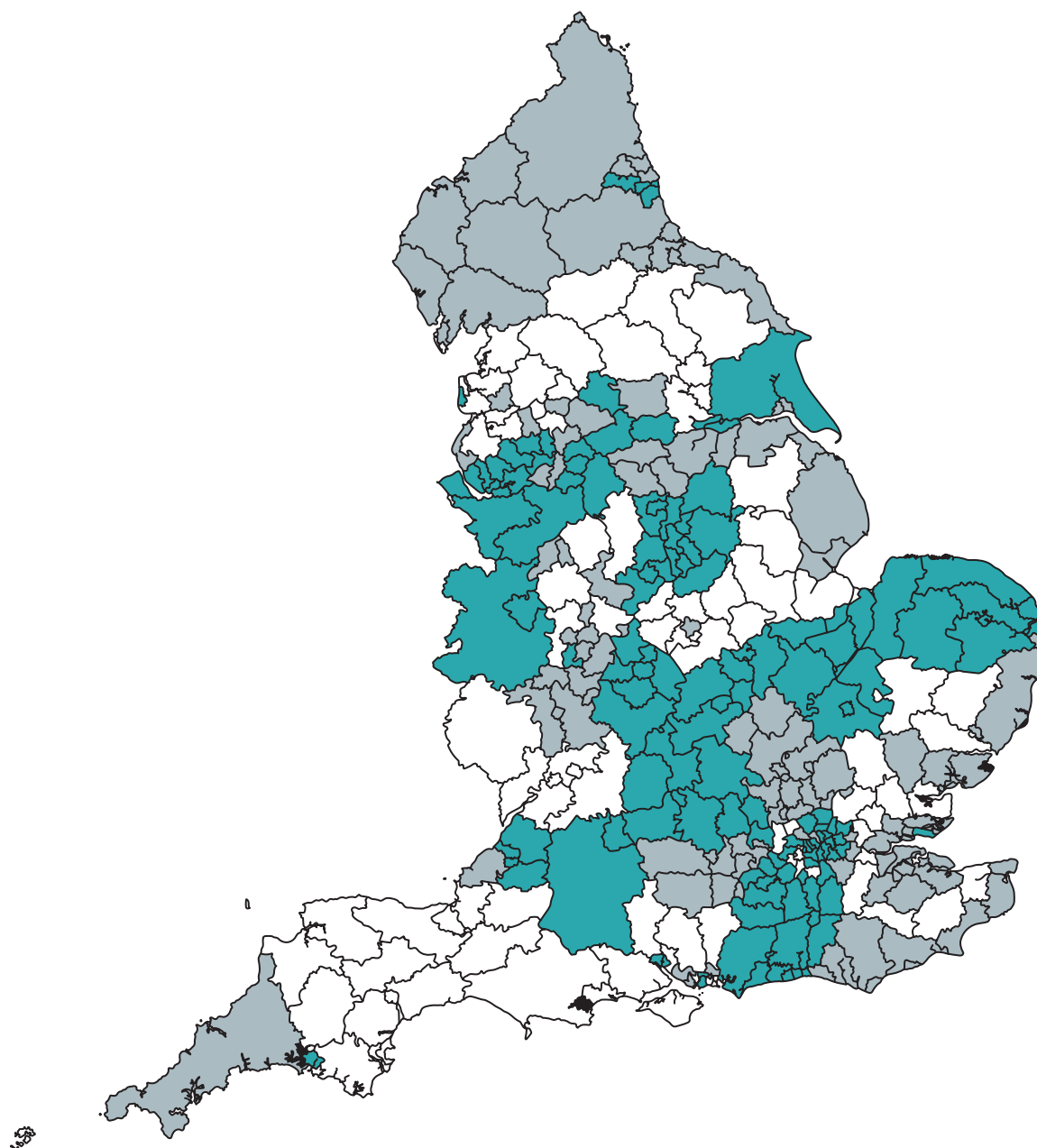
Understanding how best to target services to the most vulnerable mothers is key to improving the health of these mothers and their children. Evidence to help improve targeting is being called for by service providers, who need to understand the value of interventions in the context of their target populations and local services in order to inform commissioning and justify spending.<sup>16</sup>

## The Family Nurse Partnership and early years health visiting in England

Health visiting in England is delivered as part of the Healthy Child Programme. All families with children should receive a minimum of five visits from 28 weeks of pregnancy until the age of two and a half.<sup>17,18</sup> These mandated assessments allow health visitors to identify families in need of additional support and offer more intensive support, including additional health visitor contacts and referrals to other, more intensive, programmes. This model of proportionate universalism, an approach combining universal service provision accessible to all with more intensive services proportional to the level of need, has been recommended as key to reducing health inequalities in the UK.<sup>19</sup>

Several intensive health services aiming to reduce inequalities between adolescent and older mothers have been trialled; of these, FNP, an intensive home visiting programme supporting young first-time mothers, has a strong evidence base from several randomised trials in the USA and is recommended within the UK government's Healthy Child Programme.<sup>19,20</sup> Mothers enrolled in the FNP receive up to 64 home visits by a dedicated Family Nurse from early pregnancy until the child's second birthday. The FNP

aims to improve birth outcomes, child health and development and promote economic self-sufficiency among young mothers.<sup>21</sup> Although a randomised trial of the FNP in England found no evidence of benefit on smoking in pregnancy, birthweight, hospital admissions before age 2 or second pregnancy within 2 years, improved cognitive development outcomes were reported, and there remains strong support for the programme locally (see [Literature review – evidence of effect of Family Nurse Partnership programmes on maternal and child outcomes](#)).<sup>20-23</sup> The Building Blocks 2- to 6-year follow-up reported no evidence of effect on maltreatment outcomes but evidence of improved school readiness, measured by a Good Level of Development in the early years foundation stage profile (EYFSP) and improved educational achievement at Key Stage 1.<sup>24</sup> The FNP has been commissioned in > 130 English LAs since 2007 ([Figure 1](#)).



**FIGURE 1** Family Nurse Partnership site activity status in March 2019 among all FNP sites active during the study period (2010–9), by English LA.

## Literature review – evidence of effect of Family Nurse Partnership programmes on maternal and child outcomes

### Review approach

We conducted a literature review of the effect of FNP programmes on maternal and child outcomes using a combination of PubMed searches for 'FNP' or 'Nurse Family Partnership' (the original programme name in the USA) and identifying additional references through manual review of reference lists of previously identified papers from the USA, UK and other trials.

The evidence base for the FNP spans multiple countries and includes randomised controlled trials as well as a few non-randomised studies. Findings from this review were synthesised by the country in which the research was conducted, given differences in context and the importance of context (usual care) for the effect of interventions.

### USA randomised trials

Most of the literature on the effectiveness of the FNP stems from three randomised trials of the Nurse Family Partnership (NFP) conducted in the USA by David Olds and colleagues, including over 20 peer-reviewed articles. The trials were conducted in Elmira, New York (enrolment 1978–80), Memphis, Tennessee (enrolment 1990–1) and Denver, Colorado (enrolment 1994–5). A wide range of maternal and child outcomes were examined, with up to 20 years of follow-up.

Overall, the evidence from the three USA trials indicates a positive effect on some – but not all – maternal and child health and educational outcomes. Often, the positive effect was observed in a subsample of particularly vulnerable mothers but not in the entire cohort. The Elmira trial found a one-third reduction in all accident and emergency (A&E) admissions among children up to age 2 and ages 2–4; however, no effect was observed on all hospital admissions ages 2–4.<sup>25,26</sup> Although a reduction in mean A&E and hospital admissions for injury/maltreatment of 55% was reported in the second year of life, no such effect was detected for injury/maltreatment in ages 0–1 or 2–4. No effect was observed on this outcome for up to 2 years in the Memphis trial.<sup>27</sup> The Elmira trial was the only NFP trial to examine child abuse/maltreatment reports and found a 40% reduction in such reports up to age 15 (although this benefit was not evident before the age of 4 years).<sup>26,28</sup>

All three USA trials examined the effect of the NFP on child development and educational achievement. Results were mixed in the Elmira trial, with no effect up to age 4 for the whole sample and no effect on intellectual functioning at age 3 or 4 among children identified as maltreated.<sup>26,29</sup> There was no difference in intellectual functioning at age 3 or 4 among children of women smoking  $\geq 10$  cigarettes per day at enrolment; however, they did have higher intelligence quotient (IQ) scores (4.86 points on average) at this age than children of smoking mothers in the control arm.<sup>30</sup> The evidence in favour of a positive effect of the FNP was stronger in the Memphis and Denver trials, although these effects were concentrated in the subgroup of mothers with low psychological resources at enrolment (composite score including mental health, sense of mastery and intelligence scores), and even among this group, the positive effects were limited to only a few outcomes by age 6 and/or age 9 in the Denver trial.<sup>31–36</sup> Child mortality was only examined in the Memphis trial, which found no evidence of effect up to age 19 for all-cause mortality but a reduction in preventable-cause mortality in the NFP arm (0% vs. 1.6% in one control group,  $p = 0.04$ ).<sup>37</sup>

The effect of the NFP on maternal outcomes was weaker than on child outcomes. The Elmira trial found evidence of a 50% reduction in child abuse perpetration reports up to 15 years after giving birth.<sup>28,38</sup> There was evidence of 0.5 fewer subsequent births 15 years after the first birth among unmarried women of low socioeconomic status only in the Elmira trial but no evidence at 18 years in the Memphis trial or at 4 years in the Denver trial. However, there was evidence that NFP increased the subsequent birth interval by 5–28 months in all three trials (among the unmarried, low-socioeconomic subgroup in Elmira only).<sup>32,34,38,39</sup> There was no evidence of an effect on maternal educational qualifications beyond

6 months<sup>31,34,40,41</sup> or on experience of domestic violence in the three trials (weak evidence of a decrease in the Denver trial).<sup>28,34,42</sup> Evidence was mixed regarding the effect on drug use or impairment.<sup>34,38,42</sup> The effect of NFP on maternal mortality was only examined in the Memphis trial, with no evidence of a difference in all-cause mortality but weak evidence of a 1% reduction for mortality from external causes at 20 years.<sup>37</sup>

A more recent trial of 5670 Medicaid-eligible nulliparous pregnant mothers recruited between 2016 and 2020 in South Carolina found no evidence of an effect on birth outcomes (preterm birth, low birthweight, small for gestational age and perinatal death).<sup>43</sup>

### ***England Building Blocks randomised trial***

One randomised controlled trial of the FNP (the Building Blocks trial) was conducted in England, enrolling approximately 1600 expectant mothers in 2009–10.<sup>44</sup> The Building Blocks trial found no evidence of effect on the four primary outcomes – smoking in late pregnancy, birthweight, second pregnancy within 24 months of first birth and rates of A&E attendance or hospital admissions within 24 months of birth. Some secondary outcomes suggested small positive impacts of the FNP in the first 2 years of life, including maternally reported child cognitive and language development. Safeguarding concerns recorded in primary care records were higher for mothers enrolled in the FNP.

Results for follow-up to age 6 showed no difference for most maltreatment outcomes between the trial arms, including referrals to social services, children referred as Children in Need (CiN), duration for which children were assessed as in Need, children with a child protection plan (CPP) or who were Looked After.<sup>24</sup> However, children in the FNP arm spent on average 2 months less time in care than children in the usual care arm. There was no evidence of a difference in children not attending a hospital outpatient appointment, attending A&E for injury or ingestion or being admitted to hospital for the same causes.

Nonetheless, there was evidence of FNP's impact on some – but not all – child development and educational outcomes. There was no difference in Special Educational Needs (SEN) provision up to age 6 or educational attendance for ages 2–4. Children of FNP mothers were more likely to achieve a Good Level of Development at school entry (age 5) than in the usual care arm, with a greater beneficial impact on total point score (across 17 learning goals) observed for children of younger mothers. At Key Stage 1, children in the FNP arm were more likely to reach the expected level for reading; no other differences were observed for Key Stage 1 outcomes. The beneficial effects of the FNP were stronger among boys than girls (reading and writing), among younger mothers at enrolment (mathematics and writing) and among mothers not in employment, education or training at the time of enrolment (writing).

### ***Other randomised trials in Germany, the Netherlands and Canada***

Several other trials have been conducted in high-income countries. The VoorZorg trial in the Netherlands, enrolling in 2007–9, reported a reduction in child abuse/maltreatment reports by age 3 in the FNP arm, as well as a reduction in some types of interpersonal violence at 32 weeks of pregnancy and 24 months after birth.<sup>45,46</sup> A trial of a FNP-based model in Germany (Pro Kind) reported improved child development among high-risk women only, but no evidence of a difference in subsequent births within 2 years.<sup>47</sup> The follow-up trial evaluating outcomes at age 7 reported fewer behavioural problems in children, less child-abusive parenting, fewer maternal mental health problems and higher maternal life satisfaction in the intervention arm.<sup>48</sup> Some positive effects on mother–daughter interactions were also reported for a small subsample who agreed to participate in video recording.<sup>49</sup>

One randomised controlled trial in Canada has not yet published results on primary outcomes but has reported preliminary findings on a number of secondary outcomes, with a reduction in prenatal cannabis use and a modest reduction in cigarette use in smokers associated with the intervention but no reduction in rates of prenatal cigarette and alcohol use.<sup>50</sup>

### **Non-randomised studies in Australia, Scotland and the USA**

Non-randomised studies in the USA and Australia have reported reduced preterm births, child maltreatment, infant death and subsequent births among FNP participants compared with controls, as well as higher high school attainment and different patterns of A&E attendance.<sup>51–56</sup> These studies adjusted for confounders through propensity score matching, frequency matching and entropy balancing, although due to limited maternal characteristics, the potential for residual confounding remains. The Australian study compared participants to eligible women who were not referred to and never participated in the programme, thereby also being subject to likely residual confounding. One prospective cohort study in Scotland has not yet reported results.<sup>57</sup>

### **Other evidence**

A randomised controlled trial of group FNP in England, administering 44 FNP sessions to groups of 8–12 expectant mothers, found no evidence of effect on parenting or maternal sensitivity or on secondary outcomes [except for a higher proportion of mothers breastfeeding at 6 months, odds ratio (OR) 3.2; 95% confidence interval (CI) 0.99 to 10.6].<sup>58</sup>

### **Synthesis**

The available evidence on the effectiveness of the FNP is summarised in [Appendix 1](#).

The three USA trials of FNP showed mixed but overall positive impacts on child health and development outcomes and some maternal outcomes, similar to the more recent Netherlands trial. These results contrast with the Building Blocks trial in England, which showed no evidence of impact of FNP on most child outcomes, with the exception of some cognitive outcomes. There are two main contributing explanations for the difference in results observed in England compared with the USA and the Netherlands: first, there are likely important differences in usual care contexts between different countries. The social safety net is likely to be stronger in England than in the USA, with better access to services for adolescent mothers not enrolled in FNP (including the minimum five mandated health visiting contacts, universal health care free at the point of care, services provided through free Children's Centres, etc.), which may explain the lack of association for most outcomes in England. For example, the mothers in the control arm of the Building Blocks trial received an average 16 health visiting contacts up to the child's second birthday. Nonetheless, the usual care group in the Netherlands trial probably had access to similar or better levels of care than in England, with 9–11 home visits before the child's second birthday, as well as support from child welfare and mental health organisations,<sup>59</sup> indicating that there are important factors (beyond access to services) shaping the effect of FNP.

Second, there are notable differences in the eligibility criteria for FNP in England compared with other countries. The main eligibility criterion for enrolment in FNP in England is maternal age: adolescents who are aged up to 19 at last menstrual period (LMP), and who are first-time mothers, are eligible for enrolment as long as they live in a LA with a FNP site and are enrolled before 28 weeks of pregnancy. From November 2016, a few FNP sites extended their eligibility criteria to enable enrolment after 28 weeks gestation and among mothers aged 20–24 at LMP with other markers of vulnerability, recognising that mothers in these groups could also benefit.<sup>60</sup> Eligibility criteria for the Building Blocks trial (nulliparous, age ≤ 19, living in the catchment area of a local FNP team, < 25 weeks of pregnancy)<sup>44</sup> are therefore aligned with the practice in English FNP sites at that time. Young age is the main eligibility criteria for FNP in England, based on the ease of identifying the youngest adolescent mothers, associations between adolescent motherhood and social adversity, disrupted education and employment<sup>13,61</sup> and other factors contributing to poor birth and health outcomes among their children.<sup>5,6,62</sup>

In contrast, additional socioeconomic criteria such as unemployment, low educational level or low income are used in combination with maternal age in other countries,<sup>27,35,63</sup> based on logic models of how the original NFP was expected to provide benefits.<sup>64</sup> As a result, the population of young mothers enrolled in trials in other countries are a more selected and vulnerable group than in England, who

may stand to benefit more from the FNP (as evidenced by greater effectiveness in socioeconomically deprived groups demonstrated in the USA trials).<sup>32,36,38</sup>

### Rationale for the present study

Usual care available to adolescent mothers is likely to have declined between the Building Blocks trial study period and after the introduction of austerity measures in England – in particular, health visitor budgets have decreased since responsibility for commissioning health visiting services shifted from the NHS to local government in England in 2015.<sup>65</sup> Furthermore, evidence from the USA trials suggests that the youngest, most disadvantaged mothers are likely to benefit most from FNP.<sup>22</sup> Adequately powered subgroup analyses are needed to examine whether some groups of families benefit from FNP more than others. In addition, constrained conditions under which trials are conducted often do not match the complexity of real-world implementation of programmes.<sup>66</sup>

Linkage of existing administrative records provides a cost-efficient means of evaluating services as they are implemented in the real world by bringing together data from different sectors on a range of outcomes. They also allow for a sufficiently large sample size for subgroup analyses. Our population-based study aims to use longitudinal linked observational data between the health, education and social care sectors to evaluate the effects of FNP on outcomes of eligible mothers and their children up to age 7 to generate evidence on the factors that may influence effectiveness and programme engagement (including participant characteristics, setting, provider and programme delivery).<sup>67,68</sup> Evaluating outcomes for approximately 30,000 FNP families and up to 1 million controls built on the results of the Building Blocks trial<sup>24,44</sup> will provide increased statistical power to detect smaller differences, differences in rarer outcomes and subgroup differences for which the Building Blocks trial was underpowered. Use of these data for the real-world evaluation of FNP is important and necessary to inform the targeting and commissioning of services by generating evidence on which groups of mothers and their children benefit from the real-world implementation of FNP in England.

### Research aims and objectives

We aimed to evaluate the real-world, ongoing implementation of FNP in England on the outcomes of mothers participating in FNP and their children. Specifically, our objectives were to:

1. determine the rate of and characteristics associated with enrolment in FNP among young mothers across LAs in England
2. determine the effect of FNP on maternal and child outcomes, including identifying which families benefit the most from FNP
3. identify contextual and programme factors that might influence the effects of FNP.

## Chapter 2 Methods

Parts of this chapter have been reproduced from the published papers by Cavallaro *et al.*<sup>1</sup> and Cavallaro *et al.*<sup>2</sup> These are open-access articles distributed in accordance with the Creative Commons Attribution 4.0 Unported (CC BY 4.0) licence, which permits others to copy, redistribute, remix, transform and build upon this work for any purpose, provided the original work is properly cited, a link to the licence is given and an indication of whether changes were made. See: <http://creativecommons.org/licenses/by/4.0/>.

### Chapter outline

This chapter begins with a description of the study participants and data sources. It then describes the data linkages and manipulations performed for this study: linkage of FNP data to Hospital Admissions Data [Hospital Episode Statistics (HES)], creation of the cohort of FNP mothers and controls, creation of the child cohort and linkage of the FNP-HES mother and baby cohort to education and social care records [National Pupil Database (NPD)]. Lastly, it defines the outcome and exposure variables used, and the analyses conducted, in this study.

### Study design and participants

We created a retrospective cohort of all first-time mothers aged 13–19 years at LMP with live births in England between 1 April 2010 and 31 March 2019 and their first-born child(ren), using individual-level, linked, longitudinal data from routinely collected hospital, education and social care records. We also constructed a similar cohort of all first-time mothers aged 20–24 at LMP because some FNP sites implemented modified inclusion criteria to include young mothers up to this age. The cohort was created through linkage of hospital records (HES), education and social care records (NPD) and FNP programme data for mothers and their children. Our approach built on previous linkage of education and health records and validated methods of linking hospital records for mothers and babies.<sup>69–71</sup>

### Data sources

#### *Hospital Episode Statistics – Hospital Admissions Data*

Hospital records for mothers aged 13–24 years and their children in England were extracted from records of births and deliveries in HES. HES is a data warehouse containing details of all hospital admissions (from 1997), outpatient appointments (from 2003) and A&E visits (from 2010) at NHS hospitals in England.<sup>72</sup> HES data have been extensively used in research. In addition to the birth record, we linked information from hospital admissions and A&E attendances for mother and child (including up to 11 years before delivery for the mother; see [Appendix 2, Figure 16](#)).

Information captured in HES includes administrative data [including admission dates, NHS trust, general practitioner (GP) code]; demographic information (including age, sex, ethnicity) and clinical information (diagnoses and procedures). A unique 'Hospital Episode Statistics Identifier (HESID)' is assigned to enable episodes of care for the same individual to be combined (this has recently changed to a 'Token Person ID'). Diagnoses are coded by professional coders in hospitals using International Classification of Diseases, 10th Revision (ICD-10) codes (International Classification of Disease, version 10); procedures are coded using Office of Population, Censuses and Surveys Classification of Surgical Operations and Procedures, version 4 codes (OPCS-4).<sup>73,74</sup> Based on previous methodological work, we linked delivery records for mothers and birth records for their children within HES to create a mother–baby HES cohort.<sup>69</sup>



### ***National Pupil Database – education and social care data for mothers enrolled or not in Family Nurse Partnership and their children***

The HES cohort of mother–baby pairs were linked to education and social care records from the Department for Education for both mothers and children in FNP and comparison groups (including information before delivery for mothers). Information on assessments, attainment and progression at each Key Stage is available for all pupils in state schools in England, alongside eligibility for free school meals (FSM), information about SEN provision and information about absences and exclusions. NPD, including social care data, has been extensively used in research.<sup>75</sup>

For both mothers and their children in the cohort, we linked HES data to the following NPD databases:

- The Spring School Census (formerly PLASC), the Early Years Census, the Pupil Referral Unit (PRU) Census and Alternative Provision – including pupil-level information from 2002 (for the School Census) for pupils aged 2–19+ on SEN, FSM eligibility and information about absences and exclusions.
- The CiN Census – including information on referrals to children’s social services, assessments carried out upon these children and whether the children became the subject of a CPP, from 2008.<sup>76</sup>
- The Children Looked After (CLA) return – including information on all Looked After children and recent care leavers in England, from 2005.<sup>77,78</sup>

For mothers only, we linked to Key Stages 2 and 4 data, which include teacher assessments and/or test results in Year 6 (age 11) and Year 11 (age 16). We also linked to Key Stage 5 data (Year 12–13, ages 17–18) but did not use these data due to small numbers. For children only, we linked to the Early Years Census and EYFSP. These data include whether the child achieved a Good Level of Development at school entry (age 5), which we used as a proxy for school readiness, as well as Key Stage 1 assessment data (age 7).

A Unique Pupil Number (UPN) is used by the Department for Education (DfE) for linkage of CLA and CiN with the NPD. The UPN is usually assigned at first entry to a maintained school or nursery, typically around the age of 4–5. Therefore, it is not possible to link the NPD to CLA or CiN data for children who receive social care services only before they enter nursery/school or for some adopted children (who can be provided with a new UPN).<sup>79</sup> It is not mandatory to return UPN in CLA or CiN beyond age 16. UPN was replaced by an anonymised Pupil Matching Reference in the data that we had access to.

### ***Family Nurse Partnership information system – Family Nurse Partnership service data for mothers enrolled in Family Nurse Partnership***

The HES cohort was linked to the Family Nurse Partnership information system (FNP IS) to obtain information on participation in FNP for mothers who were enrolled in FNP. The FNP IS supports the implementation of the FNP programme in England, originally provided by NHS Digital under contract to the FNP National Unit on behalf of Public Health England. Data are reported in real time and are used locally by FNP teams and nationally by the FNP National Unit to monitor programme delivery and support quality improvement.

Data collected in the FNP IS include information from the mother and child collected at enrolment (by 28 weeks gestation at the latest, including mother’s age, marital status, living arrangements, education, employment, social care); 36 weeks gestation (including maternal health, alcohol, drugs and smoking); birth (including birthweight and gestational age) and at regular intervals until 24 months after birth (including child health and development, social care and other maternal baseline variables). Information on each visit is also collected (including date, length of visit, family nurse seen and referrals to other services). The FNP IS became functional in 2009, and data quality was reported to be high from 2010 onwards. FNP data have been used in previous research.<sup>80</sup>

The FNP IS contains maternal and child identifiers at enrolment/birth: name, sex, date of birth, postcode, GP code and NHS number. When mothers graduate from the FNP (mostly at the child’s

second birthday, but sometimes earlier), pseudonymised data are retained only by the FNP National Unit, and identifiers are held solely on secure servers at NHS Digital.

The time span covered by each data source (including look-back, study and follow-up periods) is described in [Appendix 2, Figure 16](#).

## Linkage Family Nurse Partnership-Hospital Episode Statistics

### *Linking mothers enrolled in Family Nurse Partnership to Hospital Episode Statistics*

Linkage between data from the FNP IS and HES was conducted using deterministic linkage via NHS Digital (see [Appendix 2, Tables 21](#) and [22](#)). Of the 32,040 mothers in our FNP cohort who gave birth between April 2010 and March 2019, 31,560 (98.5%) were linked to a record in HES.

### *Characteristics of unlinked mothers*

[Appendix 2, Table 24](#), describes the characteristics of the 31,560 FNP mothers who linked to a HESID and the 480 FNP mothers who either did not link to a HESID ( $n = 10$ ) or who linked to a likely incorrect HESID and were subsequently excluded ( $n = 470$ ). Compared to mothers who linked to a HESID, unlinked mothers seemed to be a slightly more vulnerable group: they were less likely to be living with their mother (with or without their partner present) or to have any GCSEs at enrolment and more likely to have missing data. They had a lower mean number of FNP visits (26, compared with 35 for FNP mothers who linked to a HESID). They were more likely to be of black, South Asian or mixed/other ethnicity and living in London.

### *Description of linkage quality*

Of the 31,560 FNP mothers included in our linked study cohort, 31,450 (99.7%) linked to HES via the FNP-HES linkage key at match rank 1 or 2, indicating high-quality links. Only 0.3% ( $n = 85$ ) of mothers linked at match rank  $> 2$ , indicating less-certain links. Twenty-five mothers ( $< 0.1\%$ ) were linked to HES manually (see [Appendix 2, Figure 17](#)).

To check for potential false matches between FNP and HES, we assessed the agreement between information recorded separately in both data sources for all FNP mothers in our cohort who linked to at least one HES admitted patient care (APC) record (see [Appendix 2, Table 25](#)). Agreement between both data sources was generally high.

## Identification of local authorities and enrolment dates for each Family Nurse Partnership site

### *Mothers aged 13–19*

There is a complex history of FNP sites in England, with site openings, closures, mergings and splits throughout the study period. In addition, the catchment area of FNP sites may have changed over time (e.g. a site may have been decommissioned for one LA in its catchment area but continue to operate in another).

We used FNP IS data to identify the first and last month-year in which expectant mothers aged 13–19 at LMP were enrolled in each FNP site based on the enrolment dates recorded in each participant's record. We calculated start and end dates separately for each lower-tier LA in each FNP site in order to allow for changes in catchment area over time. We used the lower-tier LA recorded in FNP participants' HES records because FNP IS records only upper-tier LA of residence at enrolment. Lower-tier LA was also used to identify the catchment area for each FNP site (e.g. the Hampshire FNP site included only a subset of lower-tier LAs in Hampshire). Inconsistencies were resolved through detailed consultation with the FNP National Unit, including consultation of site records. Nonetheless, some misclassification

in catchment areas or activity dates remains likely, particularly before the FNP became commissioned by LA in October 2015, when Primary Care Trust level commissioning (with potentially non-overlapping boundaries compared with LAs) meant slight changes in catchment areas may have occurred at this time.

Activity dates and lower-tier LAs included in the catchment area for 122 FNP sites are included in [Appendix 2, Table 26](#)).

### **Mothers aged 20–24**

As some sites had changed their eligibility criteria during the study period to allow some mothers aged up to 24 to be enrolled, we also planned to include mothers aged  $\geq 20$  in our analysis. We used FNP IS data to identify LAs that had extended their eligibility criteria to allow for recruitment of older mothers. We classified LAs as having extended criteria if at least 10 mothers aged 20–24 at LMP and giving birth up to 31 March 2019 were enrolled in the FNP. As with mothers aged 13–19, we defined site activity dates as the first and last month-year in which mothers aged 20–24 were enrolled in each site. We did not calculate different activity dates for lower-tier LAs in each site due to small sample sizes and because all but one site only included one lower-tier LA in their catchment area; see [Appendix 2, Table 27](#)).

## **Description of Hospital Episode Statistics cohorts**

### **Mothers aged 13–19**

This study cohort included all 130,415 mothers aged 13–19 at LMP who had their first live birth between 1 April 2010 and 31 March 2019 and whose first antenatal booking appointment as recorded in HES (or estimated date of 28 weeks gestation, if missing) occurred on a date when the FNP was active in their LA of residence ([Figure 2](#)). Of these, 99,150 (76%) were never enrolled in FNP.

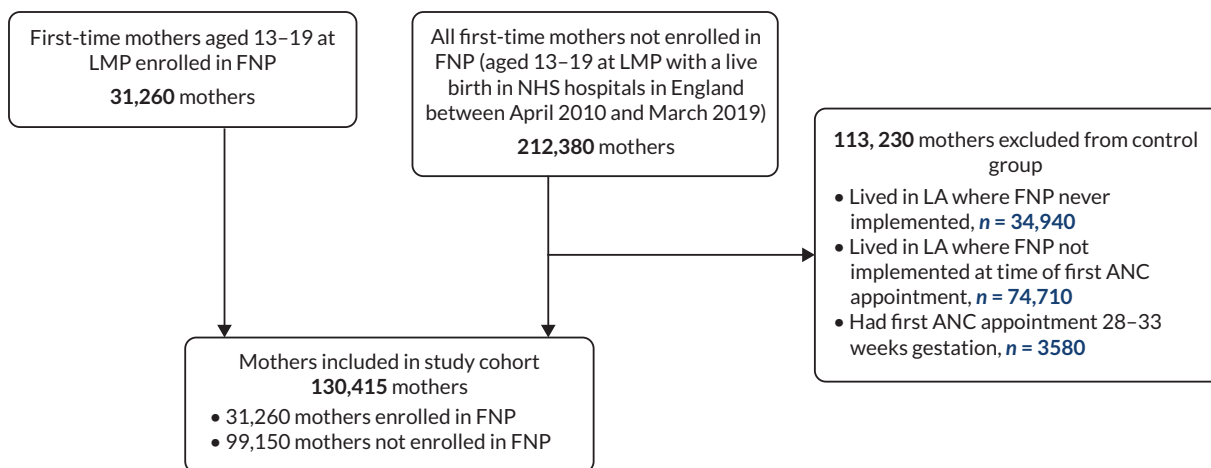
Date at LMP was estimated by subtracting gestational age at birth from the date of childbirth or subtracting 40 weeks (the median gestational age at birth among mothers aged 13–19 in our cohort) from the date of childbirth for the 13% of mothers with missing gestational age at birth. Mothers whose antenatal booking appointment occurred between 28 and 33 weeks gestation were excluded as they would not have met the eligibility criteria for the FNP (see [Figure 2](#)). This means we may have excluded a small number of eligible mothers within the few sites that allowed enrolment after 28 weeks from November 2016. Since we observed a spike in the number of mothers with a recorded gestational age at booking appointment of 33 weeks or more, we considered these to be data errors (6% of mothers) and recoded them to 28 weeks so that they could be retained within the cohort.

The creation of the study cohort of mothers aged 20–24 is described in [Appendix 2, Figure 18](#).

## **Identification of Hospital Episode Statistics child cohort**

We used two linkage keys to identify the children of mothers included in the study cohort: first, a FNP-HES mother–baby linkage key provided by the FNP IS, and second, a mother–baby linkage key based on a previously developed algorithm using de-identified HES data.<sup>69</sup>

Among the 31,425 FNP mothers in our cohort, 31,260 aged 13–19 and 165 aged 20–24 years, 31,125 (99%) were linked to a baby HESID (see [Appendix 2, Figure 18](#)). Among the 1025 mothers in our cohort with multiple births, 80 (78%) had at least two recorded baby HESIDs, 220 (21%) had only one recorded baby HESID and 5 (0.5%) had no recorded baby HESIDs. Where only one baby HESID was recorded for a multiple birth, the identified child was retained in the child study cohort.



**FIGURE 2** Identification of FNP participants and comparison group among cohort of mothers aged 13-19. Note: numbers have been rounded to the nearest 5 in accordance with NHS Digital's statistical disclosure rules for subnational analyses; totals may not be equal to the sum of component categories. ANC, antenatal care.

## Hospital Episode Statistics – National Pupil Database linkage

### Description of linkage

Linkage of all mothers and children in the study cohort to NPD education modules was performed by the DfE, following extraction of identifier information (including full name and postcode history) by NHS Digital. DfE used a matching algorithm requiring agreement (full or 'fuzzy') on names, date of birth and postcode; matching to NPD was not completed for names and date of birth only or on names and postcodes only (see [Appendix 2, Table 28](#)). Subsequent linkage to social care data was performed by DfE via the Pupil Matching Reference number.

### Linkage of maternal Hospital Episode Statistics records to National Pupil Database

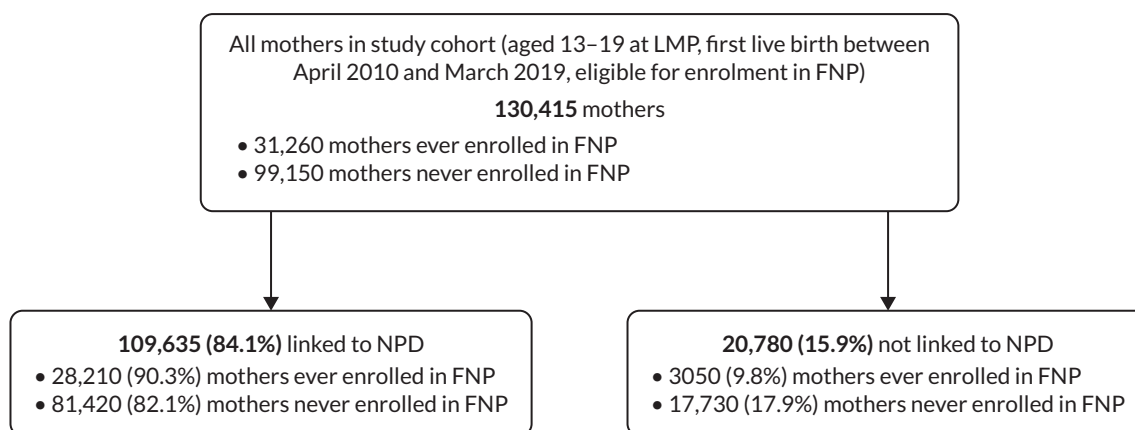
Of the 130,415 mothers aged 13-19 included in the study cohort, 109,635 (84.1%) were linked to a record in NPD ([Figure 3](#)). Mothers who were enrolled in FNP were slightly more likely to link (90%) compared with mothers who were not enrolled (82%). Overall, 98% of linked mothers linked at match strength 1, indicating fully confident matches.

### Linkage of child Hospital Episode Statistics records to National Pupil Database

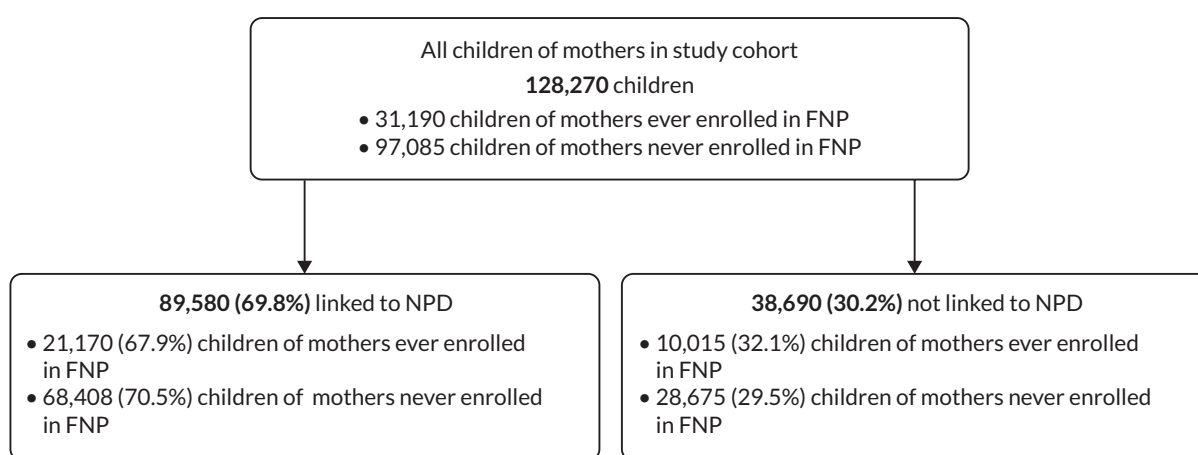
Among 128,270 children of mothers aged 13-19, 89,580 (69.8%) were linked to a record in NPD ([Figure 4](#)). Children born to FNP mothers were slightly less likely to link to NPD (68%) than those born to mothers not enrolled in FNP (71%). Overall, 97% of linked children linked at match strength 1, indicating fully confident matches.

### Characteristics of unlinked mothers and children

There were some differences in the characteristics of mothers in the study cohort who were and were not linked to NPD (see [Appendix 2, Table 29](#)). Mothers who did not link to NPD were much less likely to be of white ethnicity (65% vs. 87% among all mothers who linked) and more likely to live in the most deprived quintile (52% vs. 47%) and to have reached 20 weeks of pregnancy at antenatal booking appointment (8% vs. 5%). However, unlinked mothers were less likely than linked mothers to have vulnerability indicators relating to a history of hospital admissions – those related to mental health, adversity and chronic conditions, as well as A&E attendance.



**FIGURE 3** Description of linkage of the NPD and HES – mothers in cohort. Note: numbers have been rounded to the nearest 5 in accordance with NHS Digital's statistical disclosure rules for subnational analyses.



**FIGURE 4** Description of linkage of the NPD to HES – children in cohort. Note: numbers have been rounded to the nearest 5 in accordance with NHS Digital's statistical disclosure rules for subnational analyses.

The FNP data gave more insight into the characteristics of those who did and did not link (see [Appendix 2, Table 30](#)). FNP mothers who did not link to NPD were more likely to be living alone or in care at enrolment and to attend their antenatal booking appointment after 10 weeks of pregnancy. However, they were less likely to be recorded as CiN, having a CPP or being a child in care during pregnancy.

There were also some differences in the characteristics of children in the study cohort who did and did not link to NPD (see [Appendix 2, Table 31](#)). Children who did not link to NPD were more likely to be born from 2016 onward, less likely to have a mother of white ethnicity and slightly more likely to live in less deprived areas.

## Definition of outcome variables

Study outcomes and data sources for this study are described in [Figure 5](#) and [Table 1](#). We selected outcomes for the FNP evaluation based on the FNP logic model,<sup>64</sup> with some caveats outlined below.

### Indicators of child maltreatment

We assessed the effect of FNP on indicators of child abuse and neglect, as measured by the percentage of mothers whose baby was discharged from hospital to social services at birth, whose child had at least one unplanned hospital admission for injury or maltreatment-related diagnoses or who died (up to age 2 or 7) or whose child was ever recorded as a Child in Need, as having a CPP, or being a Child

Looked After (at age 4–5 years). ICD-10 code lists for injury or maltreatment-related diagnoses were based on previously published lists<sup>81,82</sup> and are included in [Appendix 3](#). As the UPN for linking education and social care data is usually assigned at school entry, social care data for children only involved with social care prior to school entry cannot be linked. Therefore, we only examined CPP, Child in Need and CLA status after school starting age (4–5 years). Thresholds for CiN status vary across the country: only assessments that have been ‘accepted’ are recorded within the data. The CiN data exclude some disabled children (those who are not receiving services from LAs) and children who are receiving support from LAs through early help services.<sup>83</sup> We did not have the primary need code in our data, and some children referred to social care services will be referred for reasons other than child maltreatment (e.g. child disability).

The potential for surveillance bias to distort the effect of early life interventions on child maltreatment has been extensively discussed, and nurse home visiting has been shown to result in increased contact with nurses, potentially leading to lower thresholds for referral to social care services for families enrolled in FNP than families who are not enrolled.<sup>29,44,45</sup> This bias in ascertainment of maltreatment may dilute or reverse the association between FNP participation and maltreatment. Conversely, it has also been hypothesised that a nurse’s closeness to participants may delay reporting of suspected maltreatment.<sup>45</sup> We examined CiN referral source, aiming to determine whether the proportion of referrals initiated by health visitors differed between children of mothers enrolled and not enrolled in FNP.

### **Child health, developmental and educational outcomes**

We firstly described rates of preterm birth (< 37 weeks of pregnancy) and low birthweight (< 2500 g) between groups. We also described A&E attendance and unplanned hospital admissions for any diagnosis. These were reported as descriptive outcomes since the direction of effect could be interpreted positively or negatively (FNP participation might reduce the need for emergency care or alternatively increase appropriate care seeking). Nonetheless, they represent important outcomes for understanding the effects of FNP on care-seeking behaviour.

For children reaching school age, we examined the effect of the FNP on school readiness as measured by the percentage of each group achieving a Good Level of Development as recorded within the EYFSP (level 2 + across the combined five areas of learning at school entry) at age 5, persistent absence (absent for ≥ 10% of possible school sessions), achieving expected levels at Key Stage 1 (age 7) for Mathematics, Reading and Writing and recorded as having SEN provision. We also examined FSM eligibility (pupils are recorded as eligible if a claim for FSM has been made by them or on their behalf by their parents). We also calculated the percentage of children in each group recorded in the EYFSP as having attended nursery.

### **Maternal outcomes**

For mothers, we evaluated unplanned hospital admissions for adversity-related reasons (violence, self-harm and drug/alcohol abuse) or for mental health-related diagnoses after delivery (see [Appendix 3](#)). As with child outcomes, A&E attendance and unplanned hospitalisations for any diagnoses were reported as descriptive outcomes. We also examined the effect of FNP participation on subsequent pregnancies within 18 months of the first live birth. We examined subsequent births within 18 months (rather than pregnancies within 24 months as measured in the Building Blocks trial) because 18-month birth intervals are associated with the highest risks of adverse outcomes for women and babies.<sup>84,85</sup> Amongst mothers who had not previously had the opportunity to take GCSEs (i.e. were < 16 at the start of the academic year in which they reached 20 weeks of pregnancy), we evaluated the percentage in each group who achieved 5 A\*–C grades including English/Maths at GCSE level (or equivalent), in the 2 years after delivery. We did not evaluate A-level outcomes as these data were available for < 1% of mothers. Amongst mothers who would still have been school age in the year following the academic year in which they reached 20 weeks of pregnancy (i.e. those aged < 15 at the start of the academic year in which they reached 20 weeks of pregnancy), we evaluated the percentage in each group who were enrolled in

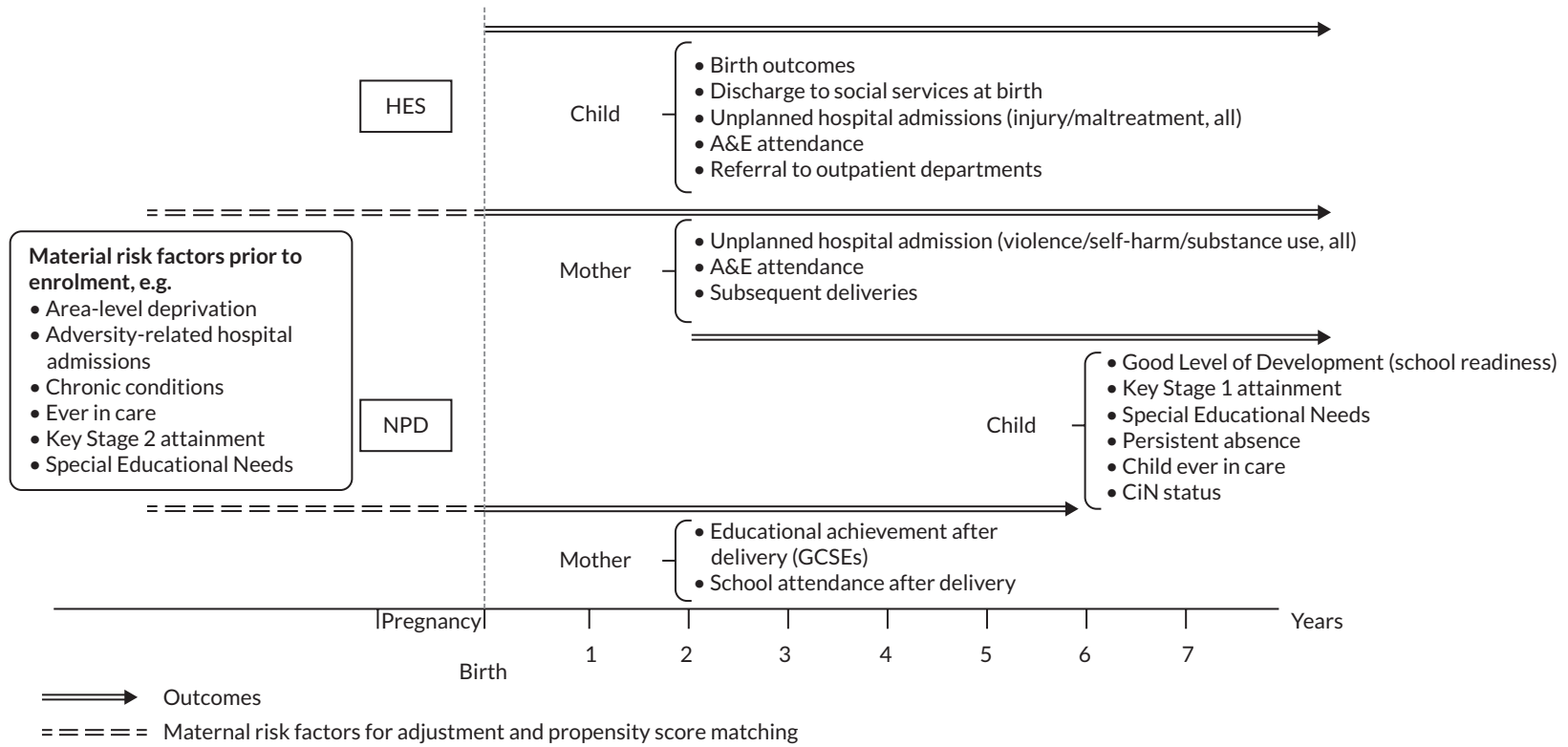


FIGURE 5 Family Nurse Partnership evaluation – data sources and outcomes.

**TABLE 1** Family Nurse Partnership outcomes and data sources

Domains	Outcomes	Years after birth	HES	NPD <sup>a</sup>
<b>Child outcomes (up to age 7)</b>				
Indicators of child maltreatment	Unplanned hospital admissions for any injury or maltreatment-related diagnosis <sup>b</sup>	0–7	✓	
	Discharge to social services at birth	0	✓	
	CLA	4/5–7		✓
	CiN status	4/5–7		✓
	CPP	4/5–7		✓
Healthcare use	Unplanned hospital admissions (any diagnoses)	0–7	✓	
	A&E visits (any diagnoses)	0–7	✓	
	Referral to outpatient departments (uptake and non-attendance)	0–7	✓	
Education	School readiness measured by a Good Level of Development in EYFSP at school entry (reception) <sup>86</sup>	5		✓
	Achieved expected levels at Key Stage 1 assessment	7		✓
	SEN provision	5–7		✓
	FSM (eligible, applies for and receives)	5–7		✓
	Persistent absence (absent for ≥ 10% possible sessions)	5–7		✓
<b>Maternal outcomes (up to 7 years following delivery)</b>				
Maternal adversity	A&E attendances (any diagnoses)	0–7	✓	
	Unplanned hospital admissions (any diagnoses and for violence, self-harm or drug/alcohol abuse) <sup>87</sup>	0–7	✓	
Reproductive outcomes	Subsequent deliveries within 18 months of index birth	0–2	✓	
Education	Key Stage 4 assessment <sup>c</sup> (5 A*–Cs at GCSE or equivalent)	0–2		✓
	School attendance after birth <sup>d</sup>	0–2		✓

a Including the School Census, CiN Census and CLA databases.

b See ICD-10 code lists for child maltreatment and health care utilisation-related outcomes.

c Among mothers who were aged < 16 at the start of the academic year in which they reached 20 weeks of pregnancy.

d Among mothers who were aged < 15 at the start of the academic year in which they reached 20 weeks of pregnancy.

school up to Year 11 during the 7 years following birth. We did not evaluate school outcomes past Year 11 or the proportion of mothers sitting GCSEs after Year 11, due to small numbers.

### Follow-up cohorts

Outcome data were available for up to 7 years after delivery, but eligibility for each outcome depended on the child's age. We therefore described outcomes (1) at birth, (2) in the 2 years following delivery and (3) in the 7 years following delivery. We describe the cohorts used for each set of outcomes in [Table 2](#).



## Definition of exposure variables

The main exposure of interest in this evaluation was enrolment in the FNP, regardless of the number of FNP visits received. Enrolment in the FNP was identified by linkage of a mother in HES to a FNP IS record.

The main maternal risk factors in this study are described in [Table 3](#). We used 20 weeks of pregnancy as the reference point since 93% of all mothers attend an antenatal booking appointment by this stage.<sup>88</sup> We selected exposures based on maternal vulnerability risk factors known to be associated with poor infant outcomes and available within HES delivery records: maternal age, ethnic background and area-level deprivation [Index of Multiple Deprivation (IMD) quintile].<sup>89</sup> We also considered maternal unplanned hospital admissions in the 2 years prior to 20 weeks gestation: mental health-related admissions (excluding self-harm and substance misuse); adversity-related admissions (violence, self-harm or substance misuse) and chronic condition admissions were identified based on published lists of ICD-10 diagnostic codes (see ICD-10 code lists for maternal hospital admissions related to adversity, mental health and chronic conditions).<sup>87,89-91</sup> Having at least one A&E attendance and repeated A&E attendances within 2 years prior to 20 weeks gestation was also considered as a risk factor. We also considered risk factors recorded in social care and education data. Seasonality of birth (quarter-year) was included based on evidence from the Building Blocks trial of associations, for example, with Key Stage 1 attainment.<sup>24</sup>

## Analyses

### Descriptive analyses

We described maternal risk factors at the time of pregnancy, previous health and educational risk factors (see [Table 3](#)) and pregnancy outcomes for all mothers in our cohort according to enrolment in

**TABLE 2** Numbers of mothers aged 13–19 and 20–24 and their children, with follow-up at birth, 2 and 7 years, in the main analysis comparing mothers who were enrolled in the FNP with mothers living in areas in which FNP was offered at the time of pregnancy

Follow-up cohort	Number of mothers			Number of children		
	Total	13–19 years	20–24 years	Total	13–19 years	20–24 years
Birth outcomes (Births 2010–9)	134,880	130,415	4465	132,660	128,270	4390
FNP mothers	31,425	31,260	165	31,350	31,190	165
Non-FNP mothers	103,445	99,150	4305	101,300	97,085	4230
2-year follow-up (Births 2010–7)	110,555	110,555	–	108,675	108,675	–
FNP mothers	25,690	25,690	–	25,630	25,630	–
Non-FNP mothers	84,860	84,860	–	83,040	83,040	–
7-year follow-up (Births 2010–2)	27,250	27,250	–	27,015	27,015	–
FNP mothers	4385	4385	–	4375	4375	–
Non-FNP mothers	22,865	22,865	–	22,640	22,640	–

#### Note

Numbers of mothers and babies differ, as we were not able to link all mothers to a child. We report maternal outcomes for all mothers, irrespective of whether they were linked. The numbers for the enrolment analysis (Objective 2) differ slightly from the 2-year follow-up cohort, due to a small number of mothers ( $n = 35$ ) who had stillbirths but were included in the enrolment analysis.

FNP. We further described maternal risk factors at enrolment and during pregnancy among mothers enrolled in the FNP (using risk factors collected in FNP IS, such as living arrangements and intimate partner violence).

### **Enrolment rate and maternal risk factors associated with enrolment in the Family Nurse Partnership (Objective 1)**

We restricted the enrolment analysis to mothers giving birth between April 2010 and March 2017 for those aged 13–19 at LMP in order to use the same cohort for Objectives 2 and 3 (ensuring at least 2 years of follow-up for all mothers and their children in the cohort). We calculated enrolment rates as the percentage of FNP participants among eligible first-time adolescent mothers living in a LA with an active FNP site at the time of first antenatal appointment before 28 weeks of pregnancy, including by site and maternal risk factor (see [Table 3](#)). We also calculated the percentage enrolment for all first-time adolescent mothers in England (including areas not offering the FNP). Multilevel logistic regression models with mothers nested within FNP sites were used to calculate crude and adjusted ORs of enrolment. Multivariable models included all maternal risk factors; multicollinearity was assessed using Spearman correlation coefficients. To examine variation in maternal risk factors for enrolment, we stratified the analysis by site characteristics: we classified FNP sites with enrolment rates in the top quartile as ‘high-enrolment sites’ and those with enrolment rates in the bottom quartile as ‘low-enrolment sites’. We stratified the multivariable models according to high-/low-enrolment site, region and financial year of delivery and tested for interactions between these strata and each maternal risk factor. We explicitly classified mothers not linking to NPD as ‘unlinked’ in relevant variables to retain them in the models.

**TABLE 3** Maternal risk factors prior to enrolment (FNP participants) or antenatal booking appointment (controls)

Maternal risk factor	Categorisation
Date of delivery	Year/quarter-year
Maternal age at birth	13–15, 16–17, 18–19, 20 years
Ethnicity	White, black, South Asian, mixed/other or unknown
Area-level deprivation at birth	Quintile of the IMD
Region of residence	South-East, London, North-West, East of England, West Midlands, South-West, Yorkshire and the Humber, East Midlands, North-East
Gestational age at booking	< 10 weeks, 10–20 weeks, 20 + weeks
History of hospital attendances in the 2 years before 20 weeks of pregnancy:	Unplanned hospital admissions for adversity-related diagnoses <sup>a</sup> Unplanned hospital admissions for mental health-related diagnoses <sup>a</sup> Any hospital admission for chronic condition-related diagnoses <sup>a</sup> Any A&E attendance Repeated A&E attendance (4 + A&E attendances) Did not attend ≥ 1 outpatient appointment
History of Social Care contacts before 20 weeks of pregnancy	Ever had a CPP Ever a CLA
Educational risk factors before 20 weeks of pregnancy	Ever recorded as having SEN provision Ever recorded as having FSM (eligible, applies for and receives) Ever in the most deprived IDACI decile Ever excluded from school, in a PRU or alternative provision Ever persistently absent (≥ 10% of possible sessions) Achieved expected levels at Key Stage 2 Mathematics/English <sup>b</sup> Achieved 5 A*–Cs at GCSE level <sup>c</sup>

IDACI, Income Deprivation Affecting Children Index.

<sup>a</sup> See [Appendix 3](#).

<sup>b</sup> At age 11 years. Only available until 2013–4.

<sup>c</sup> Amongst those who were aged ≥ 16 at the start of the academic year in which they reached 20 weeks of pregnancy.

Lastly, we built crude and adjusted funnel plots of the percentage enrolled in each FNP site according to the size of the eligible adolescent mother population, separately for mothers aged 13–17 and 18–20 at childbirth, to assess the extent to which variation in enrolment rates across sites was likely to be due to chance. The outer limits on the plots define the range of percentages that are within three standard deviations (SDs) of the national average. If the observed variation was due to chance alone, we would expect only one in 500 sites to have a percentage that is outside these limits.

We conducted a secondary analysis for first-time mothers aged 20–24 at LMP living in LAs with FNP sites enrolling these older mothers. We used the FNP data to identify LAs that had extended their eligibility criteria as those where at least 10 mothers aged 20–24 at LMP and giving birth up to 31 March 2019 were enrolled in the FNP. We included mothers whose first antenatal appointment (or estimated date of 28 weeks gestation, if date missing) occurred from the month of enrolment of the first mother aged 20–24 in the local site.

We calculated the percentage enrolment as the percentage of FNP participants among the eligible study cohort, by site and across all sites. Multilevel logistic regression models of mothers nested within FNP sites were used to calculate crude and adjusted ORs of enrolment (adjusting for all risk factors). The two least-deprived IMD quintiles were grouped to account for smaller numbers. Sample size of FNP participants was too small for analyses stratified by time, region and high/low enrolment in this age group.

### ***Effect of the Family Nurse Partnership on maternal and child outcomes (Objective 2)***

We firstly described the outcomes of interest according to maternal risk factors and enrolment in the FNP.

We then compared outcomes for mothers ever enrolled in FNP, and their children, versus those never enrolled, using two analysis strategies to account for measured confounders related to FNP enrolment and outcomes. Propensity score matching aims to minimise bias, while adjustment for confounders aims to minimise variance.

### **Propensity score matching**

Propensity score matching is a quasi-experimental approach to evaluation that is used in contexts where a randomised controlled trial is not possible. Randomisation ensures that intervention and control arms are comparable at baseline. In observational data, however, intervention and control groups are often not comparable at baseline (e.g. due to family nurses prioritising the more vulnerable mothers for enrolment). Propensity score matching aims to mimic the randomisation process by ensuring that groups being compared have similar baseline characteristics by matching mothers with similar underlying needs who were or were not enrolled in the intervention.

To derive propensity scores in this study, we first constructed regression models with FNP participation as the outcome based on all available pre-enrolment maternal characteristics.<sup>92</sup> The predicted probability of enrolment from the model (the propensity score) reflects the probability of each mother in our cohort being enrolled in the FNP, taking into account, for example, maternal age, deprivation and history of mental health conditions. Mothers with similar propensity scores in the control and intervention arms were then matched to create balanced groups for analysis.

We explored both logistic and probit models for propensity score generation and chose the model that provided the best fit. Since we know that drivers of enrolment in the FNP vary by area, we used a multilevel structure to allow for clustering of mothers (level 1) within sites (level 2), allowing intercepts to vary for each site.<sup>93</sup> We included as predictors all available maternal characteristics associated with enrolment up to 28 weeks gestation (at which point the vast majority of mothers have been

enrolled) listed in [Table 3](#), as well as additional risk factors (including 'did not attend' hospital outpatient appointments within 2 years before 20 weeks gestation and year and quarter-year of childbirth). We explored interactions, as we hypothesised that predictors of enrolment might vary according to maternal age and by year of delivery (based on our results for Objective 1).

Since there was some missing data on maternal predictors of enrolment (e.g. ethnicity and educational/social care predictors for the mothers who could not be linked to NPD), we explored two options for handling missing data in the propensity score model. First, we explicitly modelled the missing data categories (i.e. 'Unknown' ethnicity and 'Not linked to NPD'). Secondly, we used a missingness pattern information approach.<sup>94</sup> This means that we separately calculated propensity scores for the group of mothers with complete data (including all maternal variables as predictors), the group of mothers with missing data on both gestational age at booking and educational/social care variables (excluding these variables as predictors) and the groups of mothers with complete data on educational/social care variables but missing gestational age at booking (and vice versa). Matching takes place on the entire cohort using the propensity scores that have been derived in this way. Using the missingness pattern information approach, we assume that none of the following scenarios apply: (1) maternal/child outcomes affect missingness of the confounder; (2) outcome and missingness have shared unmeasured common causes and FNP enrolment, and missingness have shared unmeasured common causes and (3) the confounder and FNP enrolment both affect missingness, and the confounder is associated with outcome in the subgroup with missing data.<sup>94</sup> Our final strategy for handling missing data was determined by comparing the balance between FNP and non-FNP mothers in our matched cohort.

Once propensity scores had been generated for each enrolled and non-enrolled mother, matched groups were formed by matching mothers enrolled in the FNP to eligible non-participants within the same FNP site area with a similar propensity score. We explored using both nearest neighbour matching and calliper matching with a range of calliper widths. The selected approach was determined by inspecting the overlap in the distribution of propensity scores between mothers who were and were not enrolled in FNP and the balance of risk factors in the matched cohort.<sup>92</sup> To check the balance, we used standardised differences (effect sizes of 0.2, 0.5 and 0.8 are considered to be small, medium and large effect sizes, respectively).<sup>95</sup> We also inspected the coverage of the matched cohort in terms of the number of FNP mothers for whom a match could be found.

We explored one-to-one matching both with and without replacement, assuming that matching with replacement would minimise exclusion of mothers in the higher propensity score range. In order to determine which strategy to use, we inspected the number of times each non-FNP mother was selected as a match. We did not conduct propensity score analysis for mothers aged 20–24 due to small numbers and differing eligibility criteria and geographic range. The matching process was conducted separately for each follow-up cohort (i.e. for mothers with 2 years of follow-up and for mothers with 7 years of follow-up) to allow for equal numbers of FNP and non-FNP mothers in each group. Where mothers had given birth to multiple babies, we randomly selected one child per mother to analyse; this allowed us to keep balanced numbers in each group.

The effect of FNP was estimated by evaluating outcomes for mothers who received the intervention (i.e. who were enrolled in FNP) compared to the outcomes the same mothers would have experienced had they not received the intervention (in causal language, the average effect of the treatment on the treated). This effect was estimated as the difference in outcomes between matched groups. To estimate this difference, we calculated relative risks (RRs) with 95% CIs based on generalised linear models. We used a doubly robust approach, meaning that within the matched cohort, we adjusted for maternal risk factors. RRs presented from the propensity score analysis are therefore adjusted RRs.

All analyses were conducted in Stata V17.<sup>96</sup>

### Subgroup analyses

Interactions were used to investigate effect modification for selected outcomes according to maternal age, area-level deprivation, ethnicity, maternal history of adversity and mental health conditions, and maternal history of social care, based on previous evidence suggesting the youngest and most disadvantaged mothers are most likely to benefit from the FNP. We also explored interactions by year of delivery and region. We then presented RRs for each stratum of maternal exposure. Outcomes selected for evaluation were those with sufficient numbers to be analysed in subgroups: child unplanned admissions for maltreatment or injury up to age 2, a Good Level of Development at age 5 (school readiness), maternal unplanned admissions for any diagnosis in the 2 years following birth and subsequent births within 18 months.

### Sensitivity analyses

In the main analysis, we restricted matching within the same LA and time period in which FNP was offered within that LA (i.e. to eligible, unenrolled mothers).<sup>97</sup> Secondary analyses relaxed this restriction, aiming to achieve more closely matched groups (with potentially smaller numbers matched) by matching:

1. within the same LA but in different time periods, allowing matches to eligible families before FNP was offered in that LA
2. within the same time period but in different LAs, allowing matches to eligible families in LAs that did not offer FNP.

### Multivariable regression

We conducted unmatched regression analyses using generalised linear models to estimate RRs, adjusting for all maternal risk factors listed in [Table 3](#). Models of best fit for each outcome were selected based on AIC.

### *Contextual factors associated with benefitting from Family Nurse Partnership (Objective 3)*

#### Description of attrition, fidelity targets and dosage in the Family Nurse Partnership

Since we knew that a small number of mothers who enrolled in the FNP did not receive any visits and that some received only a small number of visits, we described attrition, mean visit length and total time spent engaging with the programme. We defined dosage in the FNP among enrolled mothers by calculating the number of completed visits relative to FNP fidelity targets ([Table 4](#)). For this analysis, we first restricted the cohort to FNP mothers aged 13–19 who had linked with HES and who gave birth before the end of January 2018 (we had information on visits until January 2020), allowing 2 years for mothers to complete the programme.

We calculated the proportion of visits completed as the actual number of visits completed divided by the expected number of visits for each mother. Some mothers may choose to leave the programme early (e.g. if they are returning to work and no longer have time for the visits or if they feel they will no longer benefit from visits). We, therefore, determined the expected number of visits by calculating the actual time spent in the programme using dates of enrolment, dates of completion and any leaving and returning dates recorded. We then determined the number of visits that should have occurred within this period based on the frequency of visits for each stage of the programme described in [Table 4](#).<sup>98</sup> This was repeated for each programme stage (pregnancy, infancy up to the child's first birthday and toddlerhood from age 1–2 years). This means that a mother who left early, but who had received all her visits before her leaving date, would be categorised as having 100% expected visits completed. The very small proportion of visits recorded as being < 15 minutes (0.2%; 2145 out of 1,010,890 visits, of which 565 visits were in the pregnancy stage, 960 in the infancy stage and 620 in the toddlerhood stage) were

**TABLE 4** Fidelity targets: number of completed visits expected at each phase of the programme

Programme phase	Frequency of visits (maximum)	Target percentage of visits	Attrition target <sup>a</sup>
Pregnancy	Weekly for first 4 weeks, then every fortnight until birth (maximum = 14, for those enrolled at the target 16 weeks of pregnancy)	80% or more	< 10%
Infancy (up to the child's first birthday)	Weekly for first 6 weeks, then fortnightly in infancy (maximum = 28)	65% or more	< 20%
Toddlerhood (child age 1–2 years)	Fortnightly for first 10 months, then monthly in toddlerhood (maximum = 22)	60% or more	< 10%

<sup>a</sup> These values were based on attrition targets reported in the Building Blocks report.<sup>99</sup>

retained within this analysis. Further information on the data cleaning for this analysis is provided in [Appendix 4](#).

### Participant, programme and nurse characteristics associated with dosage in the Family Nurse Partnership

We first described individual and programme characteristics associated with dosage in the FNP, according to maternal risk factors prior to enrolment included in [Table 3](#) and additional risk factors recorded in FNP IS (e.g. engagement of partner or parent in the FNP visits and nurse characteristics) and FNP site- or LA-specific characteristics. We evaluated which risk factors were associated with meeting the fidelity target (see [Table 4](#)) for each stage of the programme.

To evaluate the impact of these factors on dosage in the FNP, we modelled whether or not fidelity targets were met according to individual and programme characteristics. We repeated this analysis for each stage of the programme.

### Effect of contextual factors and dosage on outcomes

To determine whether meeting fidelity targets and other contextual factors (i.e. individual and programme characteristics) were associated with selected outcomes, we compared outcomes according to whether each mother had met the fidelity target for each stage of the programme, for example, comparing outcomes for mothers who had completed the target number of visits in pregnancy with those who were enrolled but did not complete the target number of visits (see [Table 4](#)). We included variables for each stage of the programme, meaning that we compared outcomes for mothers who met the fidelity target for toddlerhood with those who were present at toddlerhood but did not meet the target and with enrolled mothers who had left before toddlerhood. Outcomes included in this analysis were those included in the subgroup analysis for Objective 2: child unplanned admissions for maltreatment or injury up to age 2, a Good Level of Development at age 5 (school readiness), maternal unplanned admissions for any diagnosis in the 2 years following birth and subsequent births within 18 months. As with the multivariable regression used in Objective 2, we used generalised linear models with a multilevel structure to allow for mothers nested within FNP sites. We included maternal risk factors and nurse/programme characteristics as covariates, as we expected these to be related to both engagement and outcomes.

### Qualitative analysis

Following feedback from the Study Steering Committee and from the Family Nurses with whom we discussed the findings from this study, we decided that qualitative analysis describing the experiences of family nurses and parents would provide additional context to the quantitative analysis included in this report. This qualitative work is ongoing, but we report initial findings from the first three interviews in boxes within relevant results sections.

The interviews were semistructured and took place virtually during October and November 2022. The interviews were video recorded, transcribed and analysed by a researcher under supervision at the University of Kent. The interviewees comprised a parent (Annie), a FNP supervisor (Betsy) and a FNP nurse (Carol). Annie has two children, now aged 11 and 7, and resides in South-West England. The practitioners are employed by a LA in the same region.

A thematic analysis was completed which broadly followed the approach documented by Braun and Clarke.<sup>100</sup> This included reading and rereading the interview transcripts, coding each segment of each transcript, using the codes to generate themes; reviewing and revising the themes, providing distinct ‘... definitions and names for each theme’ and collating a concise summary to illustrate participants’ lived experiences.

### Changes from protocol

We were unable to evaluate mortality in this study due to the large discrepancies between recording of deaths in the different data sources. Date and cause of death were obtained from the Office for National Statistics (ONS) via routine linkage between HES and civil registration (deaths) data performed by NHS Digital. In-hospital deaths are recorded in HES. For mothers enrolled in FNP and their children, deaths are also recorded in the FNP IS. Of the 115 child deaths recorded in the FNP data, < 10 were captured in the ONS mortality data and 60 were captured in HES. There were < 10 child deaths captured in the ONS data and 25 in HES that were not recorded in the FNP data. Due to the small numbers involved, small differences in the numerator could substantially alter inferences; therefore, we do not report mortality for children or mothers.

To further assess the robustness of findings to the analysis approach and to evaluate any potential differences in results due to the use of real-world data, we had planned to use our cohort to replicate findings observed in the Building Blocks trial, by deriving trial outcomes for a group of families in the administrative data cohort who were similar to those enrolled in the trial. Since Building Blocks recruited between June 2009 and June 2010 (and our cohort starts with births in April 2010), we were unable to replicate the trial cohort exactly, but we had planned to conduct a supplementary analysis restricted to mothers aged 13–19 who delivered between April and June 2010 in the 18 Building Block sites (see [Appendix 2, Table 26](#)). Only 185 mothers who were enrolled in the FNP gave birth within one of the Building Blocks sites between April 2010 (when our data began) and June 2010 (when recruitment in the Building Blocks trial ended). Since the usual care context began to change around this time period (due to a reduction in the health visiting workforce and a move away from GP attachment), evaluating outcomes for mothers meeting the Building Blocks criteria, but during later years, would not have been appropriate.<sup>65</sup> Therefore, we did not perform a sensitivity analysis for this group. We had planned to conduct propensity score analysis for the group of mothers aged 20–24 at LMP but did not due to small numbers. We had planned to conduct multiple imputations as a sensitivity analysis for the multivariable regression analysis but chose not to due to the large amount of other results from sensitivity analyses presented. We included some additional outcomes (FSM and CPPs in the child) that were not described in the original protocol.<sup>1</sup>

## Chapter 3 Results

Parts of this chapter have been reproduced from the published papers by Cavallaro *et al.*<sup>1</sup> and Cavallaro *et al.*<sup>2</sup> These are open-access articles distributed in accordance with the Creative Commons Attribution 4.0 Unported (CC BY 4.0) licence, which permits others to copy, redistribute, remix, transform and build upon this work for any purpose, provided the original work is properly cited, a link to the licence is given and an indication of whether changes were made. See: <http://creativecommons.org/licenses/by/4.0/>.

### Chapter outline

This chapter begins with a description of the study cohort, providing a comparison of the characteristics of mothers who were and were not enrolled in the FNP. We then present the findings from Objective 1, which aimed to determine which groups of adolescent mothers receive FNP across LAs in England. For Objective 2, we describe child and maternal outcomes for the study cohort, providing an unadjusted comparison of outcomes for those who were or were not enrolled in the FNP (and according to maternal risk factors). We then present findings from the propensity score analysis (with sensitivity analyses) and from our multivariable logistic regression analysis. We show findings for subgroups according to maternal risk factors. Lastly, we present results from Objective 3, which aimed to evaluate the contextual factors associated with benefiting from the FNP.

### Description of study cohort

#### *Description of mothers in study cohort*

Mothers who were enrolled in FNP were strikingly different from those who were never enrolled ([Table 5](#)). FNP mothers were younger, more likely to be admitted to hospital for adversity-related diagnoses or to attend A&E in the 2 years prior to 20 weeks of pregnancy and more likely to have their booking appointment after 20 weeks of pregnancy. FNP mothers were also more likely to have been in care or have a CPP, more likely to be recorded as having SEN provision, FSM and be in the most deprived quintile according to Income Deprivation Affecting Children Index (IDACI), more likely to have been excluded or be persistently absent and less likely to achieve 5 A\*-Cs at General Certificate of Secondary Education (GCSE) level (but more likely to have achieved expected levels at Key Stage 1). Further information on the FNP cohort for mothers aged 13–19 based on data from the FNP IS is provided in [Appendix 5, Table 33](#). Similar patterns were seen for mothers aged 20–24 (see [Appendix 5, Tables 34 and 35](#)).

### Objective 1 – which groups of adolescent mothers receive Family Nurse Partnership across local authorities?

Parts of this section have been reproduced from the published paper on FNP enrolment by Cavallaro *et al.*<sup>2</sup> This is an open-access article distributed in accordance with the Creative Commons Attribution 4.0 Unported (CC BY 4.0) licence, which permits others to copy, redistribute, remix, transform and build upon this work for any purpose, provided the original work is properly cited, a link to the licence is given and an indication of whether changes were made is given. See: <http://creativecommons.org/licenses/by/4.0/>.

#### Key messages

- Only 23.2% (95% CI 23.0% to 23.5%) were enrolled in the FNP (25,680 of 110,520 eligible mothers).



## RESULTS

**TABLE 5** Selected characteristics of mothers aged 13–19 ever enrolled or not in the FNP (information from HES and NPD; full characteristics provided in [Appendix 5, Table 34](#))

	All mothers		Mothers enrolled in FNP		Mothers never enrolled in FNP	
	N	%	N	%	N	%
<b>Total</b>	<b>130,415</b>	<b>100</b>	<b>31,260</b>	<b>100</b>	<b>99,150</b>	<b>100</b>
Maternal age at delivery (years)						
13–15	2685	2.1	1450	4.6	1235	1.2
16–17	26,065	20.0	10,370	33.2	15,690	15.8
18–19	72,465	55.6	15,805	50.6	56,660	57.1
20 <sup>a</sup>	29,205	22.4	3635	11.6	25,565	25.8
Ethnicity						
White	109,820	84.2	26,330	84.2	83,485	84.2
South Asian	3695	2.8	670	2.1	3030	3.1
Black	4650	3.6	1470	4.7	3180	3.2
Mixed/other	6840	5.2	1685	5.4	5155	5.2
Unknown	5410	4.1	1110	3.5	4300	4.3
Area-level deprivation (quintile of IMD)						
Least deprived	6810	5.2	1445	4.6	5360	5.4
2	10,410	8.0	2305	7.4	8105	8.2
3	17,855	13.7	4115	13.2	13,735	13.9
4	32,550	25	7890	25.2	24,660	24.9
Most deprived	62,630	48	15,340	49.1	47,290	47.7
Unknown	160	0.1	-	-	-	-
History of admissions/attendances with diagnoses within 2 years prior to 20 weeks of pregnancy						
Adversity (violence, self-harm, substance misuse)	5475	4.2	2295	7.3	3185	3.2
Mental health (exc. self-harm/substance misuse)	3340	2.6	1400	4.5	1935	2.0
Repeat A&E attendances (≥ 4)	21,105	16.2	6860	21.9	14,245	14.4
<b>Total linked to NPD (social care and education risk factors before 20 weeks of pregnancy available)</b>	<b>109,360</b>	<b>83.9</b>	<b>28,145</b>	<b>90.0</b>	<b>81,210</b>	<b>81.9</b>
Ever excluded, in PRU or alternative provision	32,945	25.3	10,560	33.8	22,390	22.6
Ever recorded as persistently absent in a term	40,600	31.1	15,090	48.3	25,510	25.7
Ever in care	6955	5.3	3235	10.3	3720	3.8
Ever had recorded CPP	3885	3.0	1990	6.4	1895	1.9
Educational attainment (GCSEs) <sup>b</sup>						
Achieved 5 A*–C GCSEs inc. Eng/Maths	19,920	18.4	3975	14.2	15,945	19.8

**TABLE 5** Selected characteristics of mothers aged 13–19 ever enrolled or not in the FNP (information from HES and NPD; full characteristics provided in [Appendix 5, Table 34](#)) (continued)

	All mothers		Mothers enrolled in FNP		Mothers never enrolled in FNP	
	N	%	N	%	N	%
Total linked to Key Stage 2 data	104,375	80.0	27,010	86.4	77,360	78.0
Achieved expected level at Key Stage 2 (Maths)	56,930	43.7	14,175	45.3	42,755	43.1
Total linked to NPD Census (FSM, SEN available)	108,365	83.1	27,995	89.6	80,365	81.1
Ever recorded as having SEN provision	56,475	43.3	17,150	54.9	39,325	39.7
Ever recorded as having FSM	61,315	47.0	18,525	59.3	42,795	43.2

a Only including mothers aged 19 at LMP.

b Among mothers who were aged  $\geq 16$  at the start of the academic year in which they reached 20 weeks of pregnancy.

**Note**

Numbers have been rounded to the nearest 5, and cell sizes  $< 10$  have been suppressed, in accordance with NHS Digital's and DfE's statistical disclosure rules for subnational analyses.

- Enrolment rates varied substantially across 122 sites (range: 11–68%), and areas with greater numbers of first-time adolescent mothers achieved lower enrolment rates.
- Mothers aged 13–15 were most likely to be enrolled (52%; adjusted OR 2.65, 95% CI 2.39 to 2.94 compared with 18- to 19-year-olds) but accounted for only 2% of all eligible mothers.
- Only 26% of adolescent mothers with markers of vulnerability (including living in the most deprived areas and previous mental health-related hospital admissions) were enrolled.

### Enrolment among mothers 13–19

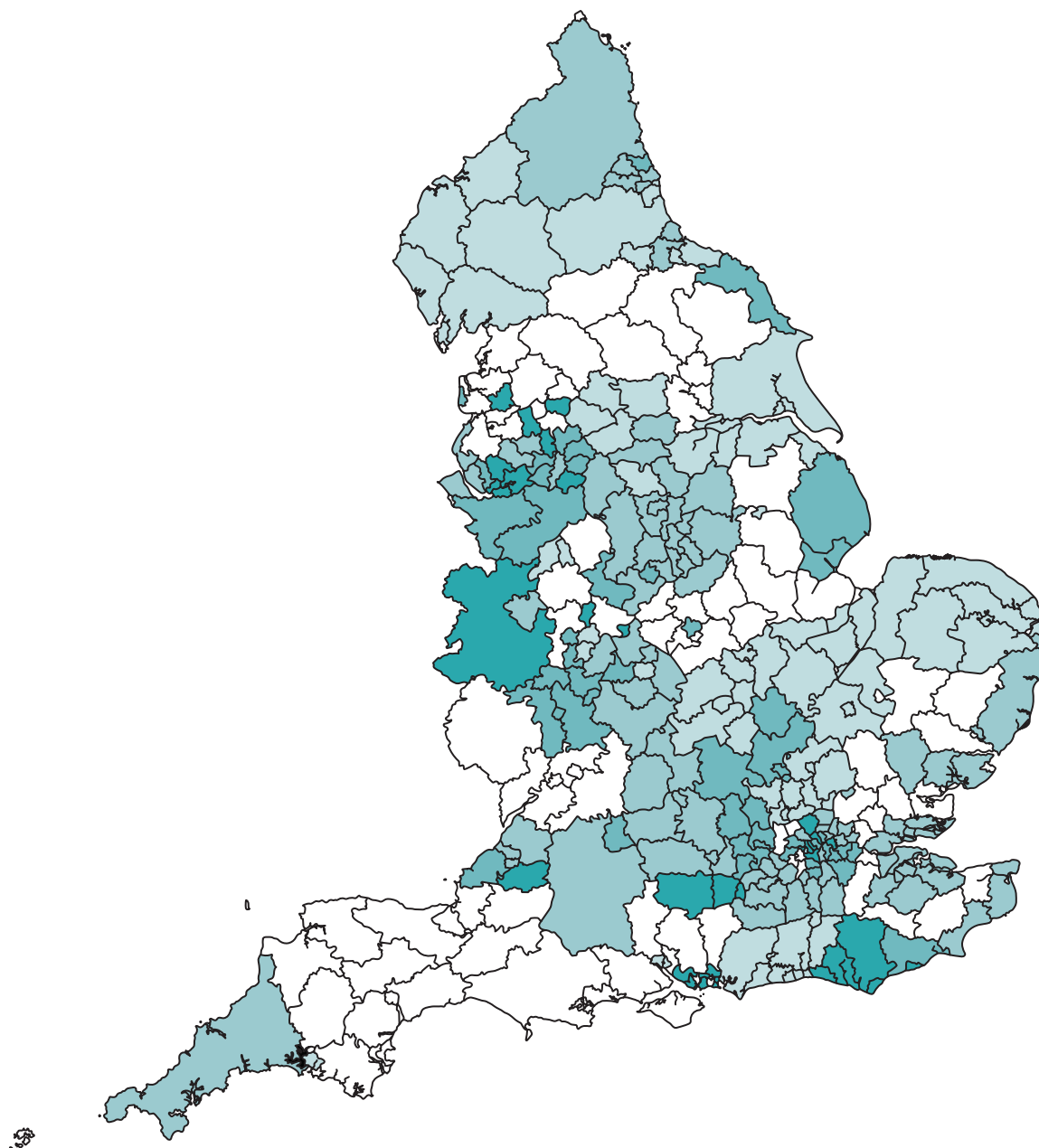
We restricted the study cohort to eligible mothers aged 13–19 giving birth between April 2010 and 2017. Among all 110,520 eligible mothers, 25,680 (23.2%; 95% CI 23.0% to 23.5%) were enrolled in the FNP. This percentage ranged across 122 FNP sites, from 11% in Cumbria to 68% in Wandsworth ([Figure 6](#)). [Appendix 2, Table 26](#), describes the 136 LAs, enrolment dates and FNP enrolment rates by FNP site.

Overall, 12.5% (95% CI 12.4% to 12.7%) of all (25,680–204,690) first-time mothers aged 13–19 giving birth in England between March 2010 and April 2017 were enrolled in the FNP.

### Risk factors for enrolment among mothers aged 13–19

Most eligible first-time mothers aged 13–19 in LAs with active FNP sites were white (85%), aged 18–19 at the time of birth (55%) and living in the most deprived quintile (49%) ([Table 6](#)). Five per cent of first-time adolescent mothers had ever been Looked After before 20 weeks of pregnancy, 32% had ever been persistently absent and 63% had attempted but not achieved 5 A\*–C GCSEs. Characteristics of eligible mothers were similar between LAs that commissioned or had never commissioned FNP (see [Appendix 5, Table 36](#)). Overall, 66% of adolescent mothers in the eligible population had at least one vulnerability marker.

The percentage of eligible mothers enrolled in the FNP was highest (52%) among those aged 13–15 years than 20 years old at childbirth (12%), although 13- to 15-year-olds accounted for only 2% of eligible mothers. The percentage of eligible adolescent mothers enrolled increased slightly from 21% in the least deprived quintile to 24% in the most deprived. Forty per cent of adolescent mothers with a history of mental health- or adversity-related admissions were enrolled, as well as 44% of mothers ever Looked After. Overall, 26% of adolescent mothers with any vulnerability marker were enrolled.



**FIGURE 6** Percentage enrolment in the FNP among eligible mothers aged 13–19, living in a LA with an active FNP site at the time of first antenatal appointment, by LA – England, births between 1 April 2010 and 31 March 2017. Note: the 122 FNP sites active during the study period covered 136 LAs (numbers and geographic boundaries of sites and LAs changed over the study period). Different sites were active for different periods within the 2010–7 cohort; the FNP was never commissioned in 15 LAs (see [Figure 1](#)).

Results from the adjusted model (see [Table 6](#)) showed that younger mothers were prioritised for enrolment [the OR decreased from 2.65 (95% CI 2.39 to 2.94) in 13- to 15-year-olds to 0.56 (95% CI 0.53 to 0.59) in mothers aged 20, compared to 18- to 19-year-olds]. Other risk factors included ever been a CLA (OR 1.92, 95% CI 1.81 to 2.04), ever had a CPP (OR 1.62, 95% CI 1.46 to 1.80) and ever identified as having SEN provision (OR 1.22, 95% CI 1.18 to 1.27).

#### ***Stratified analyses according to site enrolment level, English region and year of delivery among mothers 13–19***

Low-enrolment FNP sites included 51% of all eligible mothers in their catchment areas but enrolled  $\leq$  21% of mothers in their catchment area, while high-enrolment sites included 9% of all eligible mothers and enrolled  $>$  36% of mothers in their area (see [Appendix 5, Table 37](#)).

**TABLE 6** Risk factors for FNP enrolment among mothers aged 13–19 at LMP, living in a LA with an active FNP site at the time of first antenatal appointment (England, births between April 2010 and March 2017)

	N eligible mothers	N enrolled in FNP	% enrolled in FNP	Crude OR (95% CI)	Adjusted OR (95% CI) <sup>a</sup>
<b>Total</b>	<b>110,520</b>	<b>25,675</b>	<b>23.2</b>	–	–
Maternal age at birth					
13–15	2380 (2.2)	1240	52.1	4.62 (4.24 to 5.02)	2.65 (2.39 to 2.94)
16–17	22,725 (20.6)	8720	38.4	2.50 (2.42 to 2.59)	1.80 (1.72 to 1.87)
18–19	61,090 (55.3)	12,875	21.1	1 (ref)	1 (ref)
20 <sup>b</sup>	24,325 (22.0)	2840	11.7	0.48 (0.46 to 0.50)	0.56 (0.53 to 0.59)
Ethnicity					
White	93,730 (84.8)	21,845	23.3	1 (ref)	1 (ref)
South Asian	3170 (2.9)	535	16.9	0.55 (0.49 to 0.61)	0.74 (0.67 to 0.83)
Black	3970 (3.6)	1195	30.1	1.18 (1.09 to 1.28)	1.31 (1.21 to 1.43)
Mixed/other	5695 (5.2)	1335	23.4	0.89 (0.83 to 0.95)	0.97 (0.90 to 1.04)
Unknown	3950 (3.6)	770	19.5	0.69 (0.63 to 0.75)	0.84 (0.77 to 0.92)
IMD (quintile)					
Least deprived	5550 (5.0)	1135	20.5	0.80 (0.74 to 0.87)	0.85 (0.78 to 0.92)
2	8565 (7.7)	1820	21.2	0.91 (0.86 to 0.98)	0.95 (0.88 to 1.01)
3	14,835 (13.4)	3330	22.4	1 (ref)	1 (ref)
4	27,520 (24.9)	6430	23.4	1.07 (1.02 to 1.13)	1.02 (0.97 to 1.08)
Most deprived	53,905 (48.8)	12,820	23.8	1.19 (1.14 to 1.25)	1.07 (1.01 to 1.12)
Unknown	145 (0.1)	145	100	–	–
Unplanned admission/attendance within 2 years before 20 weeks of pregnancy					
Mental health (excluding substance misuse and self-harm)	2420 (2.2)	955	39.5	2.20 (2.03 to 2.40)	1.41 (1.27 to 1.57)
Adversity-related (self-harm, substance misuse, violence)	4460 (4.0)	1770	39.7	2.34 (2.20 to 2.50)	1.24 (1.13 to 1.36)
Any chronic condition <sup>c</sup>	9580 (8.7)	3170	33.1	1.74 (1.66 to 1.83)	1.16 (1.09 to 1.25)
A&E attendance	68,965 (62.4)	17,815	25.8	1.48 (1.43 to 1.53)	1.29 (1.25 to 1.34)
Gestational age at antenatal booking appointment					
Before 10 weeks	29,390 (26.6)	6810	23.2	1 (ref)	1 (ref)
10–20 weeks	40,640 (36.8)	9540	23.5	0.93 (0.90 to 0.97)	0.90 (0.87 to 0.94)
20 weeks or more	6095 (5.5)	1515	24.9	0.93 (0.87 to 0.99)	0.77 (0.71 to 0.82)
Unknown	34,390 (31.1)	7815	22.7	0.92 (0.89 to 0.96)	0.81 (0.78 to 0.85)

continued

## RESULTS

**TABLE 6** Risk factors for FNP enrolment among mothers aged 13–19 at LMP, living in a LA with an active FNP site at the time of first antenatal appointment (England, births between April 2010 and March 2017) (continued)

	<b>N eligible mothers</b>	<b>N enrolled in FNP</b>	<b>% enrolled in FNP</b>	<b>Crude OR (95% CI)</b>	<b>Adjusted OR (95% CI)<sup>a</sup></b>
<b>Ever had a CPP or was Looked After before 20 weeks of pregnancy</b>					
No CPP or Looked After	85,890 (77.7)	19,860	23.1	1 (ref)	1 (ref)
Looked After	5540 (5.0)	2445	44.1	2.60 (2.46 to 2.76)	1.92 (1.81 to 2.04)
CPP, but not Looked After	1685 (1.5)	800	47.5	2.95 (2.67 to 3.26)	1.62 (1.46 to 1.80)
<b>Ever recorded as having SEN provision before 20 weeks of pregnancy</b>					
No	45,270 (49.1)	9190	20.3	1 (ref)	1 (ref)
Yes	46,990 (50.9)	13,790	29.3	1.61 (1.56 to 1.66)	1.22 (1.18 to 1.27)
<b>Ever recorded as receiving FSM before 20 weeks of pregnancy</b>					
No	41,455 (44.9)	8050	19.4	1 (ref)	1 (ref)
Yes	50,805 (55.1)	14,930	29.4	1.69 (1.63 to 1.74)	1.20 (1.16 to 1.24)
<b>Educational attainment before 20 weeks of pregnancy<sup>d</sup></b>					
Did not achieve 5 A*–C GCSEs	69,345 (80.3)	16,365	23.6	1 (ref)	1 (ref)
Achieved 5 A*–C GCSEs	16,960 (19.7)	3320	19.6	0.77 (0.73 to 0.80)	1.05 (1.00 to 1.10)
<b>Ever excluded, in PRU, or alternative provision before 20 weeks of pregnancy</b>					
No	65,240 (70.1)	14,640	22.3	1 (ref)	1 (ref)
Yes	27,870 (29.9)	8620	30.7	1.55 (1.51 to 1.61)	1.05 (1.01 to 1.08)
<b>Ever persistently absent in a term (≥ 10% possible sessions) before 20 weeks of pregnancy</b>					
No	57,760 (62.0)	10,533	18.1	1 (ref)	1 (ref)
Yes	35,360 (38.0)	12,725	35.8	2.71 (2.63 to 2.80)	1.44 (1.39 to 1.50)

a Adjusted models included all variables in the table as covariates.

b Includes only mothers aged 19 at LMP.

c The definition of chronic conditions used in this analysis only includes diagnosis codes from unplanned hospital admissions.

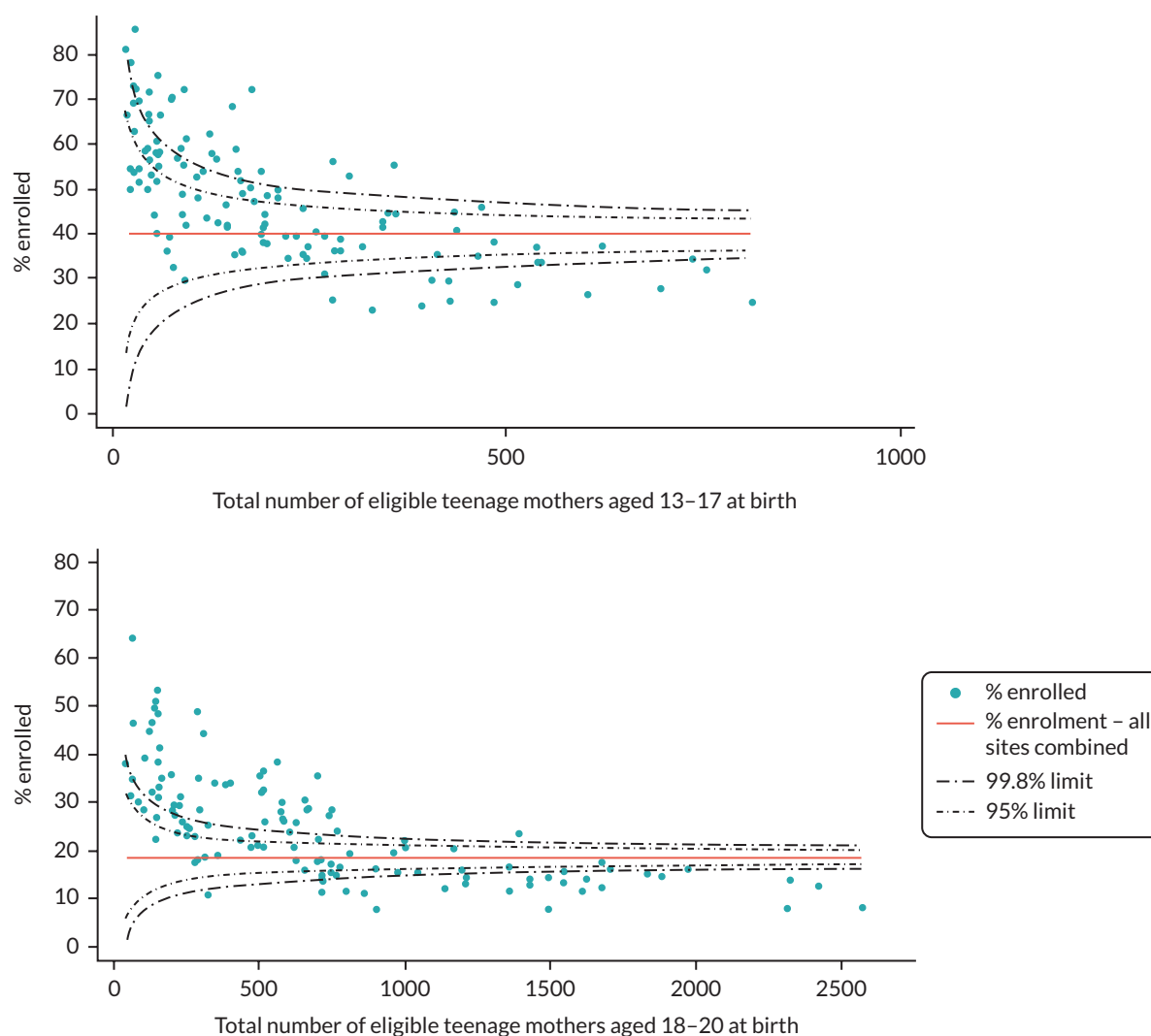
d Of those eligible to have taken GCSEs before 20 weeks of pregnancy.

### Note

Numbers have been rounded to the nearest 5, and cell sizes < 10 have been suppressed, in accordance with NHS Digital's and DfE's statistical disclosure rules for subnational analyses.

The effect of age and ethnicity on enrolment was more pronounced in low-enrolment sites (see [Appendix 5, Table 38](#)). The association between enrolment and age, ethnicity and deprivation varied across regions (see [Appendix 5, Table 39](#)). The age gradient appeared in all regions but was particularly pronounced in the South-West, East Midlands and South-East. In five of nine regions, mothers living in the most deprived areas were more likely to be enrolled than those in the middle quintile of deprivation. Conversely, London was the only region in which enrolment was higher in the least deprived areas (OR 1.68, 95% CI 1.08 to 2.63, compared with the middle quintile).

Risk factors for enrolment also varied over time (see [Appendix 5, Table 40](#)), in part due to changes in regional distribution of active sites.



**FIGURE 7** Unadjusted funnel plots of variation in FNP enrolment rates among eligible first-time mothers aged 13–19 across FNP sites, by maternal age, births between April 2010 and March 2017.

### Funnel plots of variation in enrolment rates

A substantial proportion of FNP sites' enrolment rates fell outside the funnel plot limits, indicating that much of the variation in enrolment rates across sites for younger mothers (aged 13–17 at childbirth) was unexplained by chance (Figure 7). There was even more unexplained variation among mothers aged 18–20 at childbirth, as indicated by the majority of FNP sites falling outside the funnel plot limits. Among both age groups, adjusted enrolment rates were lower than expected in sites with larger numbers of eligible adolescent mothers (see Appendix 5, Figure 27).

## Objective 2 – what was the effect of Family Nurse Partnership enrolment on maternal and child outcomes?

### Key messages

- We found no evidence of an association between FNP and indicators of child maltreatment, except for an increased rate of unplanned admissions for maltreatment/injury-related diagnoses up to age 2 for children born to FNP mothers.
- There was weak evidence that children born to FNP mothers were more likely to achieve a Good Level of Development (school readiness) at age 5 than those born to mothers who were not enrolled.

- Mothers enrolled in FNP were less likely to have a subsequent delivery within 18 months of the index birth than those not enrolled.

### ***Descriptive analysis of outcomes of interest according to maternal risk factors***

Birth, child and maternal outcomes varied substantially according to maternal risk factors (see [Appendix 6](#)). For example, children were more likely to be admitted to hospital for maltreatment or injury if they were born to younger mothers, those living in more deprived areas, those with a history of hospital admissions for adversity or mental health-related admissions, those with contact with social care services as a child and those with lower levels of education.

### ***Descriptive (unadjusted) analysis of outcomes of interest according to enrolment in Family Nurse Partnership***

#### **Indicators of child maltreatment (unadjusted)**

Over a fifth (22%) of children in our cohort were ever classified as a CiN by age 7, 4.5% had a CPP and 2.0% were Looked After at some point during this period. Children born to mothers in the FNP were more likely to have been discharged from hospital to social care services at birth and more likely to have  $\geq 1$  admission to hospital for maltreatment or injury-related diagnoses within 2 and 7 years of birth than those born to mothers who were not enrolled ([Table 7](#)). Children of mothers enrolled in the FNP were more likely to have a referral to social care services in the 7 years following birth than those of mothers who were not enrolled.

#### **Child health, developmental and educational outcomes (unadjusted)**

Low-birthweight babies and preterm births were more prevalent in mothers who were enrolled in FNP compared to those who were not ([Table 8](#)). Children born to mothers in the FNP were more likely to have  $\geq 1$  unplanned admission for any diagnosis and were more likely to attend A&E in the 2 and 7 years following birth. The mean number of admissions was similar across groups.

Children born to FNP mothers were less likely to achieve an expected level of development at school entry and less likely to achieve expected levels of development in Reading, Writing and Maths at Key Stage 1.

#### **Maternal outcomes (unadjusted)**

Mothers who were enrolled in the FNP were more likely than those who were not to have an unplanned admission to hospital for an adversity-related diagnosis or any diagnosis and more likely to attend A&E within 2 and 7 years of delivery ([Table 9](#)). Amongst mothers who gave birth before they started Year 11, mothers enrolled in the FNP were less likely than those who were not to achieve 5 A\*-Cs and GCSEs.

### ***Propensity score matching***

The best-fitting model for the propensity score was a multilevel probit model, with mothers clustered in FNP sites. We included as predictors all available maternal risk factors up to 28 weeks gestation (at which point the vast majority of mothers had been enrolled) listed in [Table 3](#). We also included interactions between maternal age and year of delivery and maternal age and gestational age at booking. We explicitly modelled the missing data categories for unknown ethnicity and mothers who did not link to NPD, as this provided a better balance between groups than using the missingness pattern information approach. There was a good overlap of propensity scores between FNP and non-FNP mothers, meaning that there were many mothers who were not enrolled in the FNP who had similar risk factors to those who were enrolled (see [Appendix 7](#), [Figure 28](#)).

The most balanced groups were achieved by using one-to-one matching without replacement with a calliper width of 0.01. Using this approach, the mean difference in propensity scores between groups was  $< 0.001$ . The standardised differences of key maternal risk factors were small (effect sizes of 0.2,

**TABLE 7** Description of indicators of child maltreatment among study cohort of first-time mothers 13–19 giving birth between April 2010 and March 2019

	All children in cohort		Children of mothers ever enrolled in FNP		Children of mothers never enrolled in FNP	
	N	%	N	%	N	%
<b>Total with information on birth outcomes</b>	<b>130,415</b>		<b>31,260</b>		<b>99,150</b>	
Discharge to social services at birth	630	0.5	255	0.8	375	0.4
<b>Total with 2 years follow-up for health outcomes (Births between April 2010 and March 2017)</b>	<b>108,675</b>		<b>25,630</b>		<b>83,040</b>	
≥ 1 unplanned admission for maltreatment or injury	5790	5.3	1700	6.6	4090	4.9
Mean no. unplanned injury/maltreatment-related admissions <sup>a</sup> (SD)		1.2 (0.7)		1.2 (0.6)		1.2 (0.7)
<b>Total with 7 years follow-up for health outcomes (Births between April 2010 and March 2012)</b>	<b>27,015</b>		<b>4375</b>		<b>22,640</b>	
≥ 1 unplanned admission for maltreatment or injury	3175	11.8	600	13.7	2575	11.4
Mean no. unplanned injury/maltreatment-related admissions <sup>a</sup> (SD)		1.3 (0.9)		1.3 (0.8)		1.3 (0.9)
<b>Total with 7 years follow-up for social care outcomes (Births between April 2010 and March 2012)</b>	<b>17,605</b>		<b>3250</b>		<b>14,355</b>	
Ever Looked After	355	2.0	85	2.6	270	1.9
Mean no. episodes of care <sup>b</sup> (SD)		1.1 (0.3)		1.1 (0.3)		1.1 (0.3)
Ever had a CPP	790	4.5	165	5.1	625	4.3
Ever had a CiN referral	3890	22.1	835	25.7	3055	21.3
Mean no. CiN referrals <sup>c</sup> (SD)		1.6 (1.0)		1.6 (1.1)		1.6 (1.0)
Mean no. CiN referrals made by health visitor <sup>c</sup> (SD)		0.0 (0.2)		0.0 (0.2)		0.0 (0.2)

a Among children with at least one admission.

b Among children with at least one period of care.

c Among children with at least one referral.

**TABLE 8** Description of selected child health, developmental and educational outcomes among study cohort of first-time mothers aged 13–19 (full outcomes provided in [Appendix 8, Table 49](#))

	All children in cohort		Children of mothers ever enrolled in FNP		Children of mothers never enrolled in FNP	
	N	%	N	%	N	%
<b>Total with information on birth outcomes (Births between April 2010 and March 2019)</b>	<b>130,415</b>		<b>31,260</b>		<b>99,150</b>	
Total with information on gestational age at birth	121,005		28,075		92,935	
Preterm birth (< 37 weeks)	9940	8.2	2650	9.4	7295	7.8
Total with information on birthweight	121,815		28,350		93,460	
Low birthweight (< 2500 g)	9395	7.7	2515	8.9	6880	7.4

continued



## RESULTS

**TABLE 8** Description of selected child health, developmental and educational outcomes among study cohort of first-time mothers aged 13–19 (full outcomes provided in [Appendix 6, Table 49](#) (continued))

	All children in cohort		Children of mothers ever enrolled in FNP		Children of mothers never enrolled in FNP	
	N	%	N	%	N	%
<b>Total with 2 years follow-up (Births between April 2010 and March 2017)</b>	<b>108,675</b>		<b>25,630</b>		<b>83,040</b>	
≥ 1 unplanned admission (any diagnosis)	40,140	36.9	10,360	40.4	29,780	35.9
≥ 1 A&E attendance	77,725	71.5	19,570	76.3	58,155	70.0
≥ 1 outpatient referral	55,630	51.2	14,310	55.8	41,320	49.8
Did not attend ≥ 1 outpatient appointment	19,745	18.2	5485	21.4	14,260	17.2
<b>Total with 7 years follow-up (Births between April 2010 and March 2012)</b>	<b>27,015</b>		<b>4375</b>		<b>22,640</b>	
≥ 1 unplanned admission (any diagnosis)	13,195	48.8	2225	50.8	10,975	48.5
≥ 1 A&E attendance	23,555	87.2	3985	91.0	19,570	86.4
≥ 1 outpatient referral	20,450	75.7	3460	79.1	16,990	75
Did not attend ≥ 1 outpatient appointment	11,150	41.3	2010	45.9	9145	40.4
<b>Total with information on nursery attendance</b>	<b>25,140</b>		<b>4135</b>		<b>21,010</b>	
Attended nursery between ages 2 and 4	24,090	95.8	3955	90.4	20,135	95.8
<b>Total with information on school readiness at age 5 (EYFSP)</b>	<b>24,585</b>		<b>4035</b>		<b>20,545</b>	
Good Level of Development (across all five domains)	14,445	58.5	2325	53.1	12,120	59.0
GLD: Communication and Language	18,595	75.6	3010	74.6	15,585	75.9
GLD: Physical Development	20,340	82.7	3325	82.4	17,010	82.8
GLD: Personal, Social and Emotional Development	19,345	78.7	3130	77.6	16,215	78.9
GLD: Literacy	15,090	61.4	2435	60.3	12,655	61.6
GLD: Maths	16,630	67.6	2685	66.5	13,945	67.9
<b>Total with information at Key Stage 1</b>	<b>24,530</b>		<b>4040</b>		<b>20,490</b>	
Expected level of development at KS1 (Maths)	16,015	65.3	2580	63.9	13,435	65.6
Expected level of development at KS1 (Writing)	14,215	57.9	2255	55.9	11,960	58.4
Expected level of development at KS1 (Reading)	16,255	66.3	2635	65.3	13,620	66.5
<b>Total with information on SEN provision and FSM</b>	<b>24,925</b>		<b>4105</b>		<b>20,820</b>	
Ever recorded as having SEN provision	6175	24.8	1120	27.8	5060	24.3
Ever recorded as having FSM	11,780	47.3	2290	56.8	9485	45.6
<b>Total with information on persistent absence</b>	<b>25,155</b>		<b>4135</b>		<b>21,020</b>	
Ever persistently absent	14,700	58.4	2555	63.3	12,145	57.8

KS1, Key Stage 1.

**Note**

Numbers have been rounded to the nearest 5, and cell sizes < 10 have been suppressed, in accordance with NHS Digital's and DfE's statistical disclosure rules for subnational analyses.

**TABLE 9** Description of maternal outcomes among study cohort of first-time mothers aged 13–19

	All mothers in cohort		Mothers enrolled in FNP		Mothers never enrolled in FNP	
	N with outcome	%	N with outcome	%	N with outcome	%
<b>Total with 2 years follow-up for health outcomes (Deliveries between April 2010 and March 2017)</b>	<b>110,555</b>		<b>25,690</b>		<b>84,860</b>	
≥ 1 unplanned admission for adversity-related diagnoses	1890	1.7	695	2.7	1195	1.4
Mean no. unplanned adversity-related admissions <sup>a</sup> (SD)		1.3 (1.1)		1.4 (1.2)		1.3 (1.1)
≥ 1 unplanned admission for mental health-related diagnoses (excluding substance misuse and self-harm)	2900	2.6	1075	4.2	1825	2.1
Mean no. unplanned mental health-related admissions <sup>a</sup> (SD)		1.5 (1.5)		1.6 (1.5)		1.5 (1.4)
Unplanned admission for any diagnosis	18,975	17.2	5210	20.3	13,765	16.2
Mean no. unplanned admissions <sup>a</sup> (SD)		1.6 (1.4)		1.7 (1.6)		1.6 (1.3)
≥ 1 A&E attendance	54,700	49.5	14,470	56.3	40,230	47.4
Mean no. A&E attendances <sup>a</sup> (SD)		2.5 (2.7)		2.8 (3.3)		2.3 (2.5)
Subsequent delivery within 18 months	10,230	8.8	2325	8.5	7905	8.9
<b>Total with information on educational attainment<sup>b</sup></b>	<b>8145</b>		<b>4225</b>		<b>3915</b>	
Mother achieved 5 A*–C inc. Eng/Maths at KS4	820	10.1	405	9.6	415	10.6
<b>Total with information on school enrolment up to Year 11<sup>c</sup></b>	<b>2035</b>		<b>4290</b>		<b>18,800</b>	
School enrolment	1675	82.3	960	81.8	710	82.9
<b>Total with 7 years follow-up for health outcomes (Deliveries between April 2010 and March 2012)</b>	<b>27,250</b>		<b>4385</b>		<b>22,865</b>	
≥ 1 unplanned admission for adversity-related diagnoses	1535	5.6	345	7.9	1190	5.2
Mean no. unplanned adversity-related admissions <sup>a</sup> (SD)		1.6 (1.6)		1.7 (2.0)		1.5 (1.4)
≥ 1 unplanned admission for mental health-related diagnoses (excluding substance misuse and self-harm)	2095	7.7	440	10.0	1655	7.2
Mean no. unplanned mental health-related admissions <sup>a</sup> (SD)		1.9 (2.4)		2.1 (3.0)		1.9 (2.1)
Unplanned admission for any diagnosis	11,585	42.5	2090	47.7	9495	41.5
Mean no. unplanned admissions <sup>a</sup> (SD)		2.4 (2.9)		2.5 (3.2)		2.3 (2.8)
≥ 1 A&E attendance	22,065	81.0	3790	86.5	18,275	79.9
Mean no. A&E attendances <sup>a</sup> (SD)		5.2 (6.7)		6.3 (8.5)		5.0 (6.2)

a Among mothers with at least one admission/attendance.

b Among mothers who were < 16 at the start of the academic year in which they reached 20 weeks of pregnancy.

c Up to Year 11, among mothers who were < 15 at the start of the academic year in which they reached 20 weeks of pregnancy.

#### Note

Numbers have been rounded to the nearest 5, and cell sizes < 10 have been suppressed, in accordance with NHS Digital's and DfE's statistical disclosure rules for subnational analyses.

0.5 and 0.8 are considered to be small, medium and large effect sizes, respectively; see [Appendix 7, Table 48](#)).<sup>95</sup> However, since FNP mothers tended to have higher propensity scores (median = 0.39) than non-FNP mothers (median = 0.31), there were a small number of FNP mothers for whom we were unable to find a match (see [Appendix 7, Figure 29](#)). When matching the entire cohort of mothers aged 13–19 giving birth between 2010 and 2019, we were able to include 94.9% of mothers in the matched analysis. For the cohort with 2 years of follow-up (births between April 2010 and March 2017), we matched 95.7% of FNP mothers, and for the cohort with 7 years of follow-up (births between April 2010 and March 2011), we matched 99.9% of FNP mothers. The comparatively lower match rates for the later years were due to a smaller number of untreated mothers for these years. Using matching with replacement may have increased the proportion of matched mothers further but would have led to increased imbalance between groups.

## Outcomes within matched cohort

### *Indicators of child maltreatment*

There was an increased risk of unplanned admissions for maltreatment/injury-related diagnoses in the 2 years following birth amongst children of mothers who were enrolled in the FNP compared with those who were not (RR 1.15, 95% CI 1.07 to 1.24). There was weak evidence that FNP was associated with an increased risk of a hospital record indicating discharge to social services at birth (RR 1.23, 95% CI 1.00 to 1.51;  $p$ -value 0.046) and a decreased risk of a CPP up to 7 years after birth (RR 0.84, 95% CI 0.71 to 1.00;  $p$ -value 0.049). There were no other differences between groups in any of the indicators of child maltreatment that were evaluated ([Table 10, Figure 8](#)). Due to small numbers, we did not calculate RRs for the percentage of CiN referrals from health visitors.

### *Child health, developmental and educational outcomes*

There was an increased risk of low birthweight amongst mothers who were enrolled in the FNP versus those who were not (RR 1.07, 95% CI 1.02 to 1.13). There was also an increased risk of unplanned admission for any diagnoses (in the 2 years following birth) and for A&E attendances (in the 2 and 7 years following birth).

There was weak evidence that children born to FNP mothers were more likely to achieve a Good Level of Development (school readiness) at age 5 (RR 1.05, 95% CI 1.00 to 1.09) than those born to mothers who were not enrolled. Children in the FNP arm were also more likely to be recorded as having FSM (see [Table 11, Figure 9](#)).

### *Maternal outcomes*

Mothers who enrolled in the FNP were more likely to have unplanned admissions for adversity-related diagnoses, mental health conditions or any diagnoses and A&E attendances in the 2 and 7 years following birth, compared to those who were not enrolled (see [Table 12, Figure 10](#)). However, these mothers were less likely to have a repeat pregnancy within 18 months of the index birth (RR 0.92, 95% CI 0.88 to 0.97).

### *Subgroup analyses*

Although there was variation in the association between FNP and outcomes across subgroups, there were no statistically significant interactions between enrolment in FNP and maternal age, ethnicity, area-level deprivation, maternal contact with social care services, child sex or year of delivery (see [Figures 11–14, Appendix 7, Appendix 8, Figures 31–34](#)). However, we did observe a significant interaction between region and subsequent births within 18 months ( $p = 0.0018$ ). The reduction in subsequent births associated with FNP was seen most strongly in the South-West, South-East and London (see [Appendix 8, Figure 33](#)).

### Sensitivity analyses

We performed two sensitivity analyses where the approach to propensity score matching was changed to allow matching (1) within the same LA but in different time periods (comparing FNP mothers with similar mothers before FNP was offered in that LA) and (2) within the same time period but in different LAs (comparing FNP to similar mothers living in different LAs). It was more difficult to find closely matched groups within these sensitivity analyses since the characteristics of mothers differed over time and between LAs that did or did not offer the FNP. We therefore also present results from a matching with replacement strategy, aiming to retain a higher coverage of FNP mothers (see [Appendix 2, Table 31](#)). Results from these sensitivity analyses did not differ substantially from those of the main analysis.

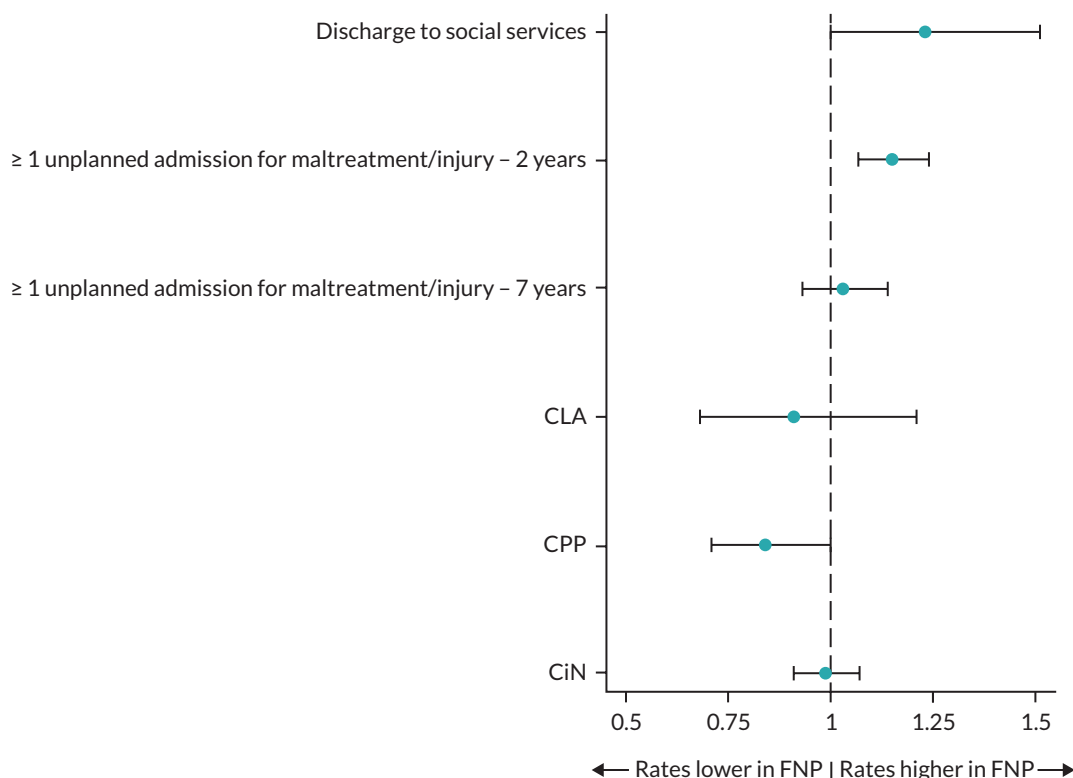
### Multivariable regression (adjusted) analyses

Effect estimates from the sensitivity analyses using multivariable regression (see [Appendix 9, Tables 55–57](#)) were broadly similar to those from the main propensity score analysis, with some differences between groups being attenuated.

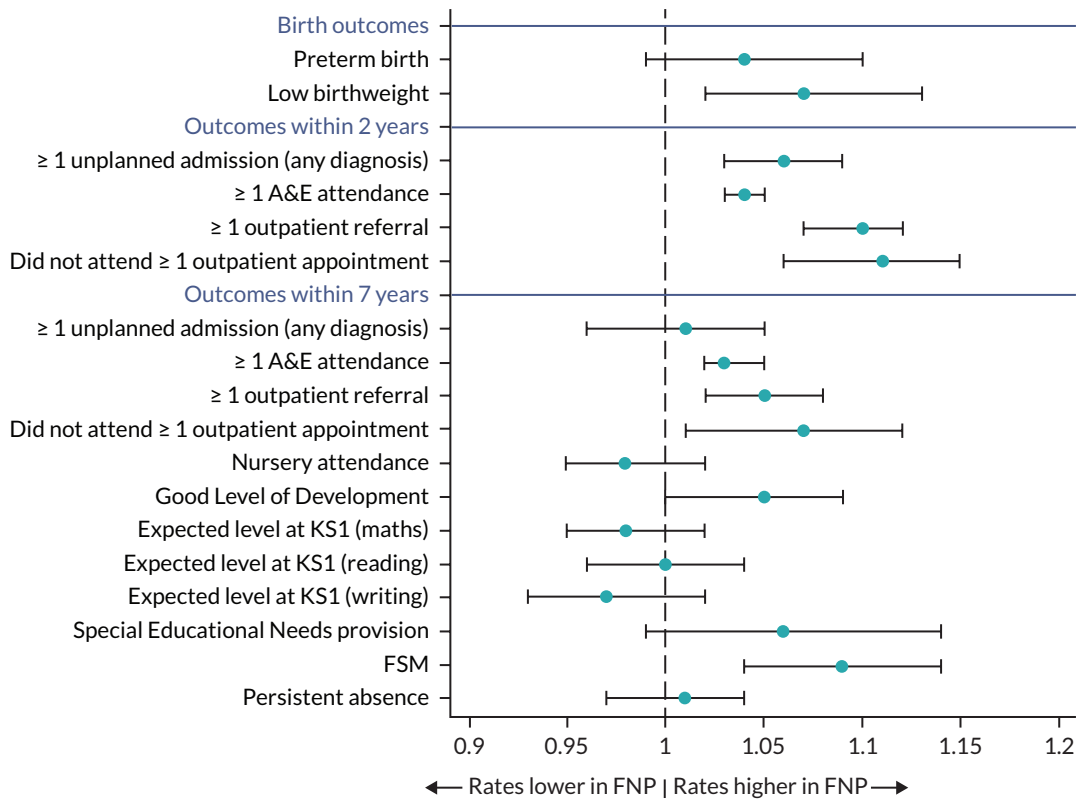
## Objective 3 – which programme and contextual factors influence the effect of Family Nurse Partnership?

### Key messages

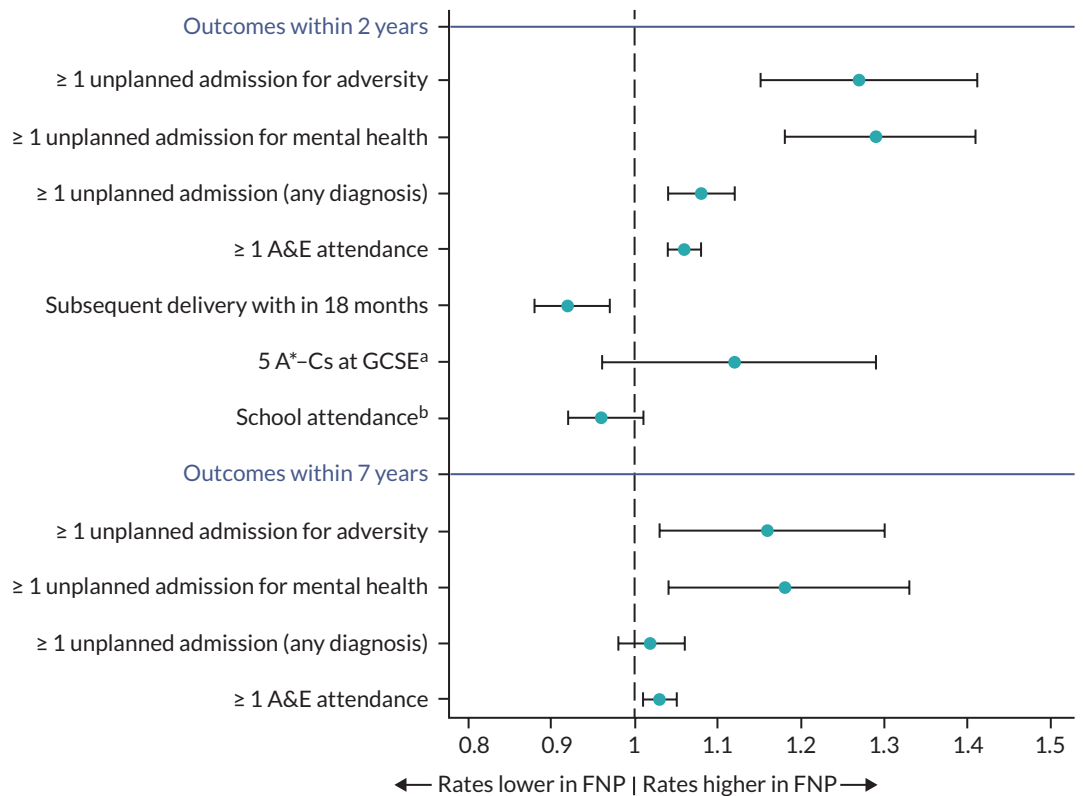
- Fifty-eight per cent of mothers enrolled in FNP completed the programme, and 42% left early.
- Mothers enrolled in FNP received an average of 38 visits and 42 hours of contact time with a family nurse.
- Fifty-nine per cent of mothers in pregnancy, 65% in infancy and 61% in toddlerhood met targets for the expected number of visits.



**FIGURE 8** Indicators of child maltreatment: adjusted RRs and 95% CIs comparing outcomes for mothers enrolled in the FNP vs. mothers who were not enrolled, for mothers aged 13–19 and giving birth in an area in which FNP was offered at the time of pregnancy.



**FIGURE 9** Child health, developmental and educational outcomes: adjusted RRs and 95% CIs comparing mothers enrolled in the FNP vs. mothers who were not enrolled, for mothers aged 13–19 and giving birth in an area in which FNP was offered at the time of pregnancy. KS1, Key Stage 1.



**FIGURE 10** Maternal outcomes: adjusted RRs and 95% CIs comparing outcomes for mothers enrolled in the FNP vs. mothers who were not enrolled, for mothers aged 13–19 and giving birth in an area in which FNP was offered at the time of pregnancy. a, Among mothers who were aged < 16 at the start of the academic year in which they reached 20 weeks gestation. b, Among mothers who were aged < 15 at the start of the academic year in which they reached 20 weeks gestation.

**TABLE 10** Relative risks and 95% CIs for indicators of child maltreatment comparing mothers enrolled in the FNP vs. mothers who were not enrolled, for mothers aged 13–19 in the propensity-score-matched cohort

	N (%) in mothers enrolled in FNP (treated)	N (%) in mothers never enrolled in FNP (untreated)	AdjustedRR (95% CI) <sup>a</sup>
Birth outcomes (Births between April 2010 and March 2019)			
<i>Total with information at discharge</i>	28,995	28,710	
Discharge to social services	215 (0.7)	180 (0.6)	1.23 (1.00 to 1.51)
Child outcomes – within 2 years (Births between April 2010 and March 2017)			
<i>Total with information on health outcomes within 2 years</i>	24,240	23,790	
≥ 1 unplanned admission for maltreatment or injury	1605 (6.6)	1385 (5.7)	1.15 (1.07 to 1.24)
Child outcomes – within 7 years Births between April 2010 and March 2012			
<i>Total with information on health outcomes within 7 years</i>	4330	4310	
≥ 1 unplanned admission for maltreatment or injury	595 (13.6)	575 (13.2)	1.03 (0.93 to 1.14)
<i>Total with information on social care outcomes within 7 years</i>	3215	2965	
CLA	85 (2.6)	85 (2.9)	0.91 (0.68 to 1.21)
CPP	165 (5.1)	180 (6.1)	0.84 (0.71 to 1.00)
CiN referral	830 (19.0)	785 (18.0)	0.99 (0.91 to 1.07)

a Variables for adjustment were those from [Table 3](#); different models were adjusted for different variables according to the model of best fit.

#### Note

Numbers have been rounded to the nearest 5, and cell sizes < 10 have been suppressed, in accordance with NHS Digital's and DfE's statistical disclosure rules for subnational analyses.

- Younger mothers and those with a history of unplanned hospital admissions for mental health, adversity or chronic health conditions, received a greater number of visits; other contextual factors, including nurse characteristics and area-level characteristics, had little effect on the number of visits received.
- Meeting the target for the number of expected visits in pregnancy was associated with a reduction in subsequent births within 18 months; meeting the target in infancy and toddlerhood was associated with an increase in the number of children with unplanned hospital admissions for maltreatment/injury up to age 2.

### Description of attrition, fidelity targets and dosage in the Family Nurse Partnership

Of the 31,260 mothers aged 13–19 at LMP enrolled in FNP and giving birth between 2010 and 2019, with linkage to HES (see [Figure 2](#)), 28,155 gave birth before January 2018 and were included in this analysis. Of these, 28,120 had at least one visit recorded, 16,305 (58%) completed the programme and 42% left early (slightly higher than the target attrition rate of 40%). A small number of clients had some interrupted periods of enrolment where they left the programme and returned later on (see [Appendix 4](#)).

## RESULTS

**TABLE 11** Relative risks and 95% CIs for health, developmental and educational outcomes comparing mothers enrolled in the FNP vs. mothers who were not enrolled, for mothers aged 13–19 in the propensity-score-matched cohort

	<b>N (%) in mothers enrolled in FNP (treated)</b>	<b>N (%) in mothers never enrolled in FNP (untreated)</b>	<b>Adjusted RR (95% CI)<sup>a</sup></b>
<b>Birth outcomes</b> (Births between April 2010 and March 2019)			
<i>Total with information on gestational age at birth</i>	26,485	27,375	
Preterm birth (< 37 weeks of gestation)	2465 (8.4)	1375 (8.0)	1.04 (0.99 to 1.00)
<i>Total with information on birthweight</i>	26,740	27,625	
Low birthweight (< 2500 g)	2345 (7.9)	2240 (7.6)	1.07 (1.02 to 1.13)
<b>Child health outcomes – within 2 years</b> (Births between April 2010 and March 2017)			
<i>Total with information on health outcomes within 2 years</i>	24,240	23,790	
≥ 1 unplanned admission for any diagnosis	9705 (39.7)	9110 (37.3)	1.06 (1.03 to 1.09)
≥ 1 A&E attendance	13,435 (54.9)	12,235 (50.0)	1.04 (1.03 to 1.05)
≥ 1 outpatient referral	5110 (21.1)	4455 (18.7)	1.10 (1.07 to 1.12)
Did not attend ≥ 1 outpatient appointment	1990 (46.0)	1860 (43.2)	1.11 (1.06 to 1.15)
<b>Child health outcomes – within 7 years</b> (Births between April 2010 and March 2012)			
<i>Total with information on health outcomes within 7 years</i>	4330	4310	
≥ 1 unplanned admission for any diagnosis	2200 (50.5)	2225 (51.0)	1.01 (0.96 to 1.05)
≥ 1 A&E attendance	3945 (90.5)	3800 (87.2)	1.03 (1.02 to 1.05)
≥ 1 outpatient referral	18,460 (75.5)	17,285 (70.7)	1.05 (1.02 to 1.08)
Did not attend ≥ 1 outpatient appointment	3430 (78.7)	3265 (74.9)	1.07 (1.01 to 1.12)
<b>Child developmental/educational outcomes – within 7 years</b> (Births between April 2010 and March 2012)			
<i>Total with information on nursery attendance</i>	4090	4040	
Nursery attendance	3915 (89.8)	3870 (88.8)	1.00 (0.99 to 1.01)
<i>Total with information on EYFSP</i>	3990	3955	
Good Level of Development (school readiness) <sup>b</sup>	2295 (57.5)	2190 (55.4)	1.05 (1.00 to 1.09)
<i>Total with information on Key Stage 1 attainment</i>	4270	4260	
Expected levels at KS1 (maths)	2550 (58.5)	2485 (57.0)	0.98 (0.95 to 1.02)
Expected levels at KS1 (reading)	2600 (59.6)	2490 (57.1)	1.00 (0.96 to 1.04)
Expected levels at KS1 (writing)	2225 (51.0)	2180 (50.0)	0.97 (0.93 to 1.02)
<i>Total with information on SEN/FSM</i>	4060	4010	

**TABLE 11** Relative risks and 95% CIs for health, developmental and educational outcomes comparing mothers enrolled in the FNP vs. mothers who were not enrolled, for mothers aged 13–19 in the propensity-score-matched cohort (*continued*)

	N (%) in mothers enrolled in FNP (treated)	N (%) in mothers never enrolled in FNP (untreated)	Adjusted RR (95% CI) <sup>a</sup>
SEN provision	1105 (25.3)	1025 (23.5)	1.06 (0.99 to 1.14)
FSM	2265 (51.9)	2035 (46.7)	1.09 (1.04 to 1.14)
<i>Total with information on absence</i>	4090	4040	
Persistent absence	2530 (61.9)	2450 (60.6)	1.01 (0.97 to 1.04)

KS1, Key Stage 1.

a Variables for adjustment were those from [Table 3](#); Different models were adjusted for different variables according to the model of best fit.b Results for different domains of the GLD are provided in [Appendix 8, Table 50](#).**Note**

Numbers have been rounded to the nearest 5, and cell sizes &lt; 10 have been suppressed, in accordance with NHS Digital's and DfE's statistical disclosure rules for subnational analyses.

**TABLE 12** Relative risks and 95% CIs for maternal outcomes comparing mothers enrolled in the FNP vs. mothers who were not enrolled, for mothers aged 13–19 in the propensity-score-matched cohort

	N (%) in mothers enrolled in FNP (treated)	N (%) in mothers never enrolled in FNP (untreated)	Adjusted RR (95% CI) <sup>a</sup>
Maternal outcomes – 2 years (Births between April 2010 and March 2017)			
<i>Total with information on health outcomes within 2 years</i>	24,455	24,455	
≥ 1 unplanned admission for adversity-related diagnoses	605 (2.5)	485 (2.0)	1.27 (1.15 to 1.41)
≥ 1 unplanned admission for mental health-related diagnoses	950 (3.9)	745 (3.0)	1.29 (1.18 to 1.41)
≥ 1 unplanned admission for any diagnosis	4860 (19.9)	4520 (18.5)	1.08 (1.04 to 1.12)
≥ 1 A&E attendance	13,610 (55.7)	12,750 (52.1)	1.06 (1.04 to 1.08)
Subsequent delivery within 18 months	2065 (8.4)	2270 (9.3)	0.92 (0.88 to 0.97)
<i>Total eligible for and with information on GCSEs</i>	2825	2765	
5 A*–Cs at GCSE level	330 (11.7)	255 (9.2)	1.12 (0.96 to 1.29)
<i>Total eligible for and with information on school enrolment</i>	770	680	
School enrolment	620 (80.5)	570 (83.8)	0.96 (0.92 to 1.01)
Maternal outcomes – 7 years (Births between April 2010 and March 2012)			
<i>Total with information on health outcomes within 7 years</i>	4360	4360	
≥ 1 unplanned admission for adversity-related diagnoses	345 (7.9)	300 (6.9)	1.16 (1.03 to 1.30)

continued



## RESULTS

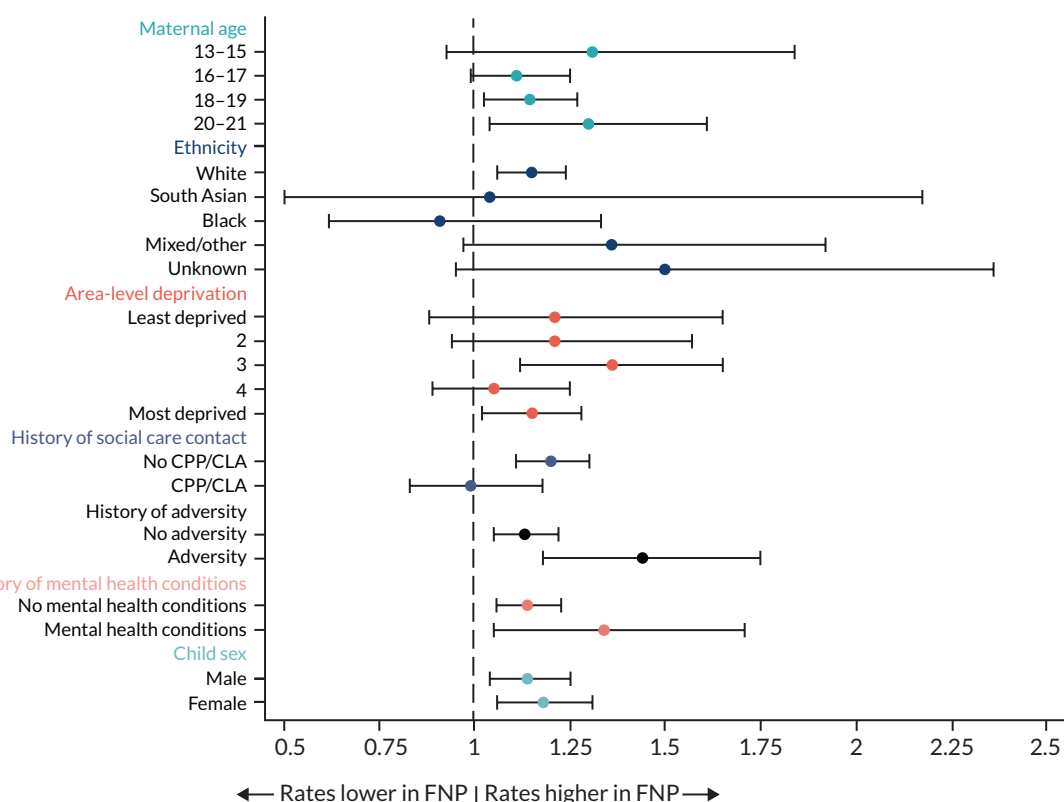
**TABLE 12** Relative risks and 95% CIs for maternal outcomes comparing mothers enrolled in the FNP vs. mothers who were not enrolled, for mothers aged 13–19 in the propensity-score-matched cohort (*continued*)

	N (%) in mothers enrolled in FNP (treated)	N (%) in mothers never enrolled in FNP (untreated)	Adjusted RR (95% CI) <sup>a</sup>
≥ 1 unplanned admission for mental health-related diagnoses	435 (10.0)	385 (8.8)	1.18 (1.04 to 1.33)
≥ 1 unplanned admission for any diagnosis	2080 (47.7)	2040 (46.8)	1.02 (0.98 to 1.06)
≥ 1 A&E attendance	3775 (86.6)	3665 (84.1)	1.03 (1.01 to 1.05)

<sup>a</sup> Variables for adjustment were those from [Table 3](#); Different models were adjusted for different variables according to the model of best fit.

### Note

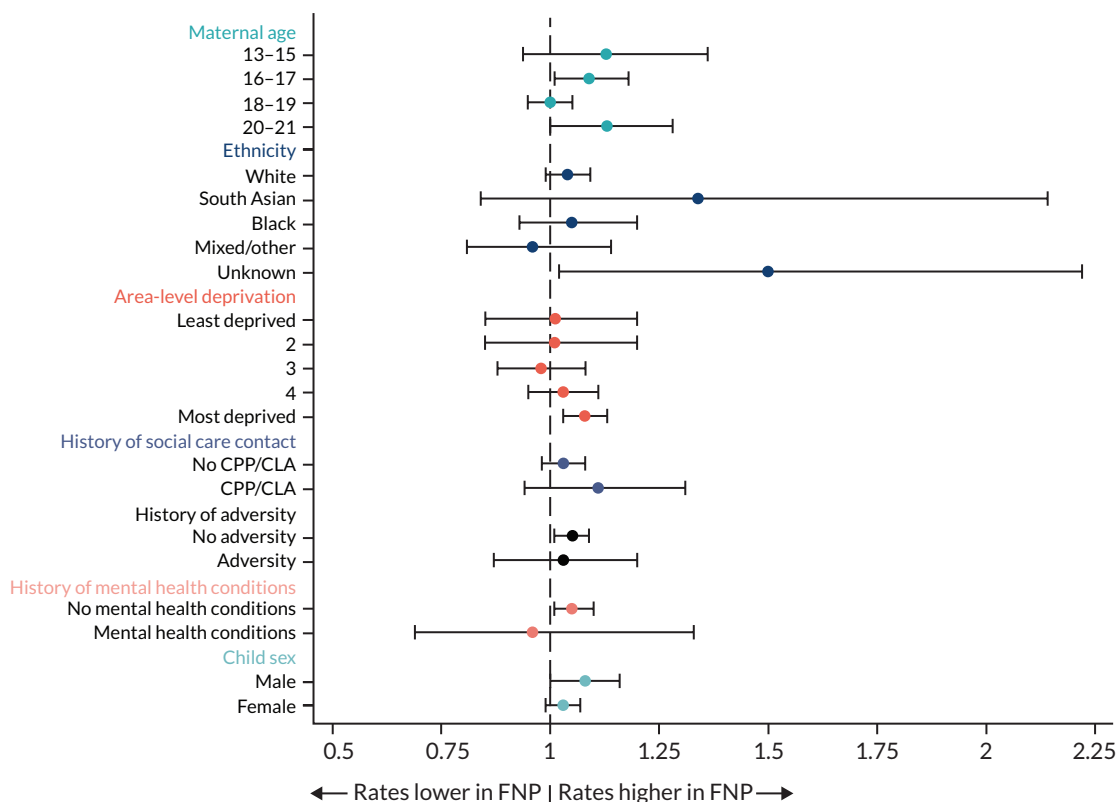
Numbers have been rounded to the nearest 5, and cell sizes < 10 have been suppressed, in accordance with NHS Digital's and DfE's statistical disclosure rules for subnational analyses.



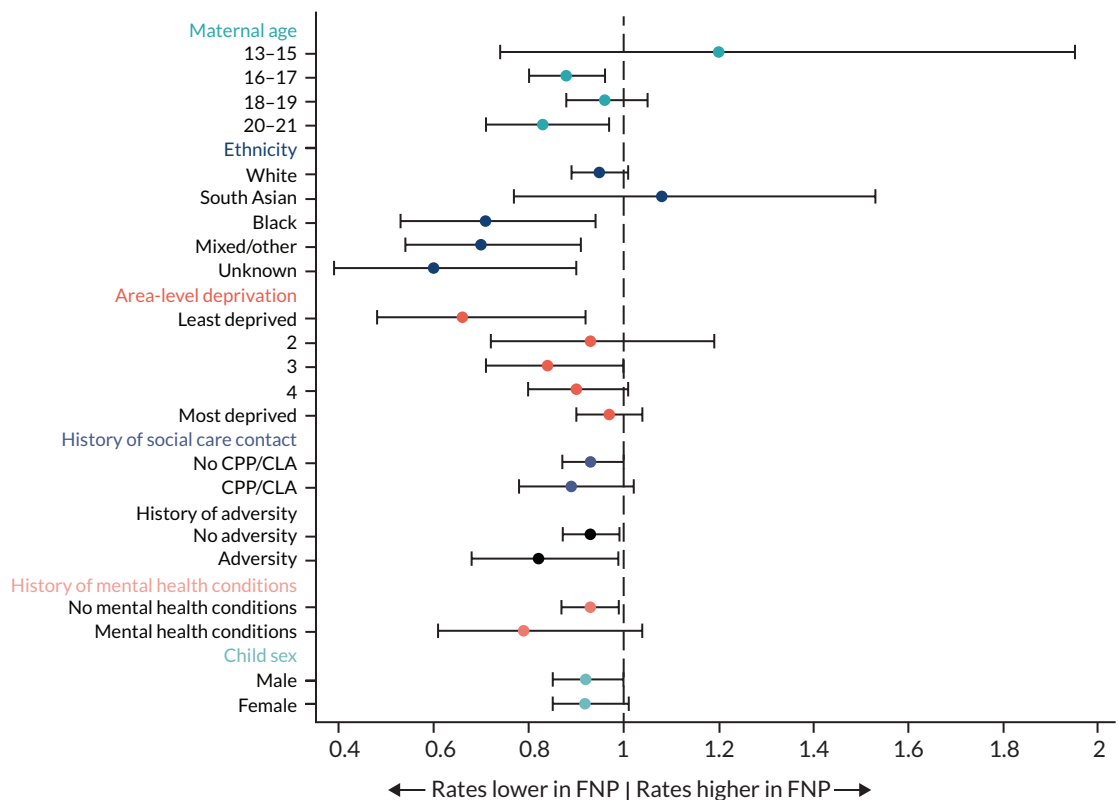
**FIGURE 11** Child unplanned admissions for maltreatment/injury in the 2 years following birth: subgroup analysis presenting adjusted RRs and 95% CIs comparing mothers enrolled in the FNP vs. mothers who were not enrolled, for mothers aged 13–19 and giving birth in an area in which FNP was offered at the time of pregnancy.

On average, mothers received a total of 38 visits during their enrolment in the FNP ([Table 13](#)), corresponding to an average 42 hours of contact time with a family nurse.

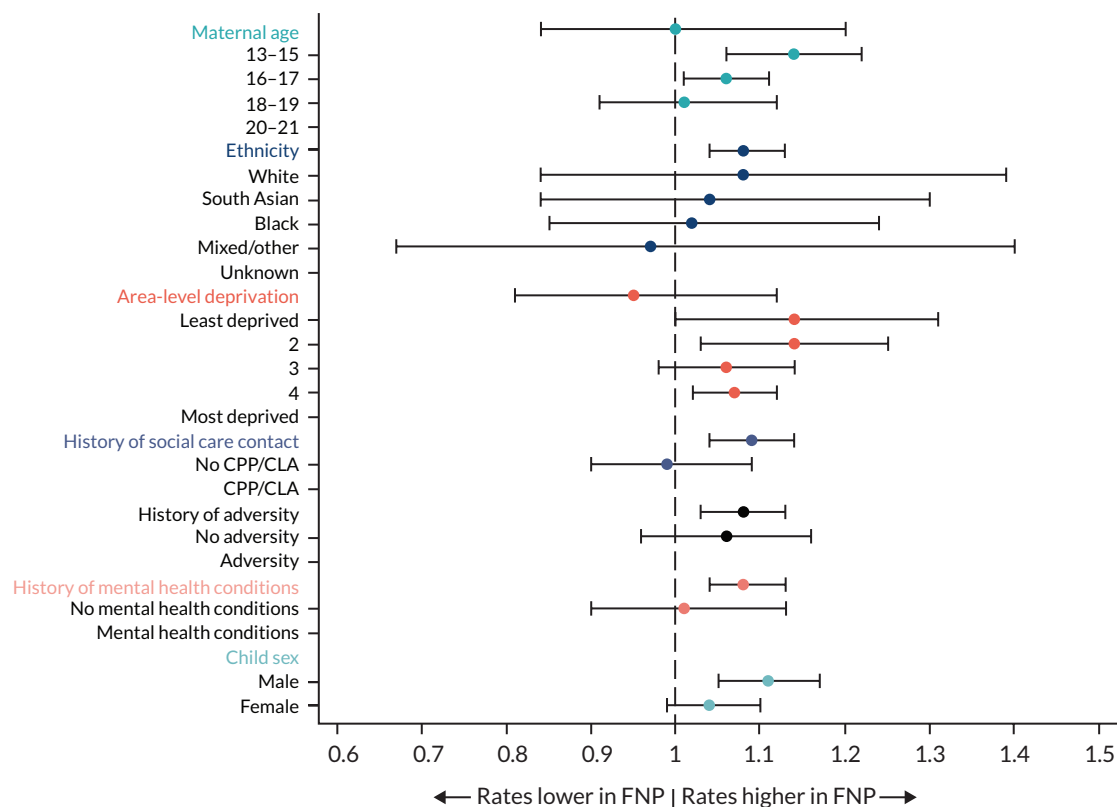
At each stage of the programme, there is a target number of visits that mothers should receive, and fidelity to these targets is measured (see [Table 4](#)). Mothers are expected to receive at least 80% of the maximum number of visits during pregnancy, 65% during infancy and 60% during toddlerhood.



**FIGURE 12** Good level of development: subgroup analysis presenting adjusted RRs and 95% CIs comparing mothers enrolled in the FNP vs. mothers who were not enrolled, for mothers aged 13-19 and giving birth in an area in which FNP was offered at the time of pregnancy.



**FIGURE 13** Subsequent delivery within 18 months: subgroup analysis presenting adjusted RRs and 95% CIs comparing mothers enrolled in the FNP vs. mothers who were not enrolled, for mothers aged 13-19 and giving birth in an area in which FNP was offered at the time of pregnancy.



**FIGURE 14** Maternal unplanned admissions for any diagnosis in the 2 years following delivery: subgroup analysis presenting adjusted RRs and 95% CIs comparing mothers enrolled in the FNP vs. mothers who were not enrolled, for mothers aged 13–19 and giving birth in an area in which FNP was offered at the time of pregnancy.

FNP also has targets for attrition: no more than 10% during pregnancy, 20% during infancy and 10% during toddlerhood.

### Pregnancy stage

The majority of FNP mothers (25,925; 92%) remained in the programme for the full pregnancy (see [Table 13](#)). Eight per cent of mothers dropped out before delivery, and a small number left during pregnancy but returned later (see [Appendix 4](#)). For mothers giving birth before January 2018, the FNP fidelity target of < 10% attrition during pregnancy was met.

The maximum possible number of visits during pregnancy is 14 (for those enrolled at 16 weeks of pregnancy), and the average number of visits in our cohort was 10. A total of 16,695 (59%) mothers met the target of 80% of visits completed during pregnancy. The distribution of visits is summarised in [Appendix 9](#).

### Infancy stage

Of the 25,975 mothers who were still in the programme at the start of the infancy stage, 19,860 (77%) completed the infancy period in full; 70 mothers were in the infancy period for < 2 weeks, and a small number restarted the programme during the infancy period (i.e. left during pregnancy and returned during infancy). Overall, attrition during infancy was 23% (5855), slightly exceeding the 20% target.

For the infancy period, the maximum possible number of visits is twice that of pregnancy (28). In our cohort, the average number of visits in this stage received remained similar to those received in pregnancy (10 visits). A total of 16,945 (65%) met the target of 65% of visits completed for this stage. The distribution of visits is summarised in [Appendix 9](#).

### Toddlerhood stage

Of the 20,015 participants remaining in the programme at the toddlerhood stage, 16,175 (81%) completed the toddlerhood stage in full; 25 mothers were in the toddlerhood stage for < 2 weeks, and

a small number of mothers left and returned during the toddlerhood stage. Overall attrition was 19% (3760), higher than the 10% target.

For the toddlerhood stage, the maximum possible number of visits is 22. The average number in our cohort was 14 visits, and 12,115 mothers (61%) met the 60% fidelity target (see [Table 13](#)). The distribution of visits is summarised in [Appendix 9](#).

### **Participant, programme and nurse characteristics associated with dosage in the Family Nurse Partnership**

There was substantial variation in whether sites met delivery targets for each stage of the programme, illustrated by the lack of overlap in CIs in [Figure 15](#).

Younger mothers and those with a history of unplanned hospital admission for mental health, adversity or chronic health conditions received a greater number of visits over their time in the programme (see [Appendix 10, Table 58](#)). There was little variation in the average number of visits or proportion of mothers meeting fidelity targets according to nurse characteristics (see [Appendix 10, Table 59](#)). However, we did see some patterns according to the number of visits with a partner present: mothers whose partner was present for 10–50% of visits tended to receive more visits than those whose partner was never present or those whose partner was present for > 50% of visits. A similar pattern was seen with the presence of parents.

When adjusting for all these maternal factors ([Table 14](#)), the greatest drivers of meeting fidelity targets in the pregnancy stage were maternal age (RR 1.13, 95% CI 1.08 to 1.19 comparing mothers aged

**TABLE 13** Summary of time and visit targets in each stage of the FNP programme for mothers with births between April 2010 and January 2018 aged 13–19 at LMP

	Full programme	Pregnancy	Infancy	Toddlerhood
Number of mothers who started each stage	28,155	28,155	25,975	20,015
Attrition <sup>a</sup> (%)	11,850 (42.1)	2180 (7.7)	5855 (22.5)	3760 (18.8)
Number of mothers who were in each stage for > 2 weeks	28,155	28,155	25,905	19,990
Mean time in the stage (SD), weeks	94.9 (41.3)	20.3 (6.4)	46.0 (13.1)	45.2 (14.6)
Median time in the stage (IQR), weeks	118 (63–128)	21 (16–25)	52 (52–52)	52 (46–53)
Mean number of visits (SD)	35.9 (17.0)	9.8 (3.6)	10.3 (3.3)	13.3 (6.5)
Median number of visits (IQR)	38 (24–49)	10 (8–12)	10 (8–13)	14 (9–18)
N that met target <sup>b</sup> (%)	7745 (27.5)	16,695 (59.2)	16,945 (65.4)	12,115 (60.6)
Number of mothers with visit data recorded	28,120	28,085	25,635	19,695
Mean visit length (SD), hours <sup>c</sup>	1.2 (0.2)	1.2 (0.2)	1.1 (0.2)	1.1 (0.2)
Median visit length (IQR), hours <sup>c</sup>	1.0 (1.0–1.3)	1.2 (1.0–1.5)	1.1 (1.0–1.2)	1.0 (1.0–1.2)
Mean total time spent with a nurse (SD), hours	42.1 (21.4)	12.1 (5.1)	21.5 (9.0)	15.4 (8.0)
Median total time spent with a nurse (IQR), hours	43 (27–57)	12 (9–15)	22 (16–27)	15 (10–20)

IQR, interquartile range.

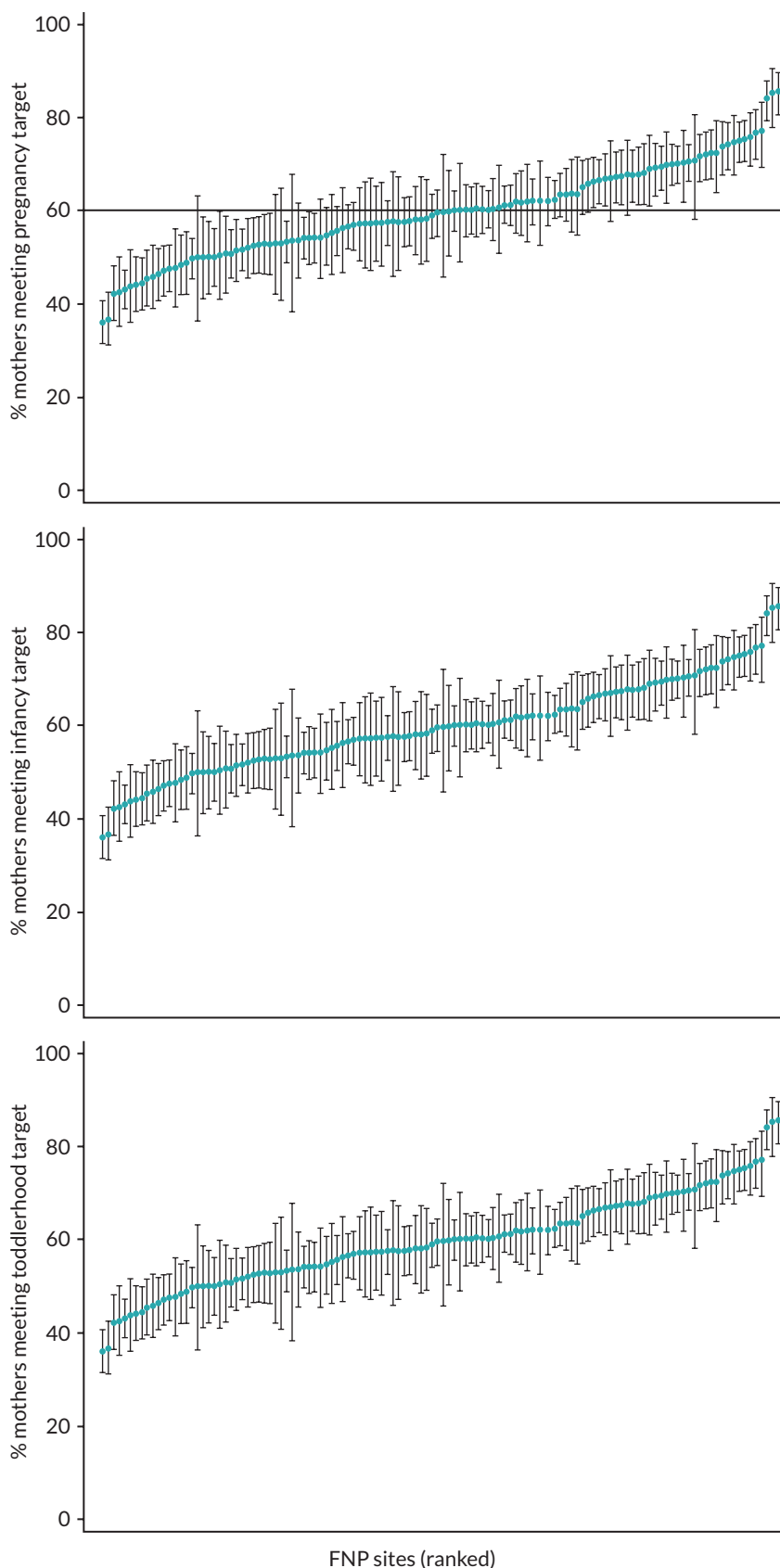
a Attrition targets: < 10% during pregnancy, < 20% during infancy and < 10% during toddlerhood.

b Target % of completed visits: 80% during pregnancy, 65% during infancy and 60% during toddlerhood. N for the full programme is the number of mothers meeting targets in all stages.

c These are the mean of the means or medians of the medians (i.e. mean number of visits for each mother, averaged across all mothers).

#### **Note**

Numbers have been rounded in accordance with NHS Digital's guidance on statistical disclosure control for subnational analyses.



**FIGURE 15** Percentage of mothers meeting fidelity targets for the number of expected visits in pregnancy, infancy and toddlerhood, according to FNP site, for births between April 2010 and January 2018 to mothers aged 13–19 at LMP. The solid line indicates the fidelity target.

13–15 with those aged 18–19), having a history of adversity (RR 1.06, 95% CI 1.02 to 1.09 compared to mothers with no history of adversity), being a CiN at enrolment (RR 1.18, 95% CI 1.14 to 1.21 compared to mothers not CiN at enrolment) and having a CPP at enrolment (RR 1.20, 95% CI 1.14 to 1.26).

Mothers who had ever been recorded with persistent absence or who had been excluded were less likely to meet targets, and those who had achieved 5 A\*–C GCSEs prior to enrolment were more likely to meet targets (see [Table 14](#)).

The greatest driver of meeting fidelity targets during the infancy and toddlerhood stages was having met the targets in the previous stages of the programme ([Tables 15](#) and [16](#)). The area-level factors we explored (% of mothers in the area who were adolescents, ethnic distribution, % of preterm births, % of mothers smoking at delivery and rates of referrals to children’s social care or CPPs) did not have a significant association with meeting fidelity targets, except for LA-level deprivation, where mothers in the most deprived LAs were more likely to have the expected number of visits.

### **Effect of programme and contextual factors and dosage on outcomes**

Within the group of mothers enrolled in FNP, none of the additional participant, programme or nurse characteristics (see [Appendix 10](#), [Table 59](#)) were associated with child unplanned admissions for maltreatment or injury up to age 2, a Good Level of Development at age 5 (school readiness), maternal unplanned admissions for any diagnosis in the 2 years following birth or subsequent births within 18 months.

However, we observed that meeting the target for the number of expected visits in pregnancy was associated with a reduction in subsequent births within 18 months (RR 0.87, 95% CI 0.78 to 0.97 compared with mothers who did not meet the target in pregnancy, [Table 17](#)). Meeting the target in infancy and toddlerhood was associated with an increase in the number of children with unplanned hospital admissions for maltreatment/injury up to age 2 ([Table 17](#)).

**TABLE 14** Pregnancy targets: maternal, programme and area-level characteristics associated with meeting fidelity targets in pregnancy, for mothers giving birth between April 2010 and January 2018 aged 13–19 at LMP

	<b>N mothers (% of all mothers)</b>	<b>N who met pregnancy target (% of group)</b>	<b>Adjusted RR (95% CI)<sup>a</sup></b>
<b>Total</b>	<b>27,360 (100)</b>	<b>16,610 (60.7)</b>	<b>-</b>
Maternal age at birth			
13–15	1315 (4.8)	930 (70.7)	1.13 (1.08 to 1.19)
16–17	9225 (33.7)	5735 (62.2)	1.04 (1.02 to 1.07)
18–19	13,715 (50.1)	8145 (59.4)	1.00 (ref)
20 <sup>b</sup>	3105 (11.3)	1800 (58.0)	0.97 (0.93 to 1.00)
History of adversity-related admissions with diagnoses within 2 years prior to 20 weeks of pregnancy			
Ever in care prior to 20 weeks of pregnancy	2695 (9.9)	1770 (65.7)	1.08 (1.05 to 1.11)
Ever excluded, in PRU or alternative provision prior to 20 weeks of pregnancy	9140 (33.4)	5450 (59.6)	0.94 (0.92 to 0.96)
Ever recorded as persistently absent in a term prior to 20 weeks of pregnancy	13,385 (48.9)	8165 (61.0)	0.97 (0.95 to 0.99)

continued

## RESULTS

**TABLE 14** Pregnancy targets: Maternal, programme and area-level characteristics associated with meeting fidelity targets in pregnancy, for mothers giving birth between April 2010 and January 2018 aged 13–19 at LMP (continued)

	N mothers (% of all mothers)	N who met pregnancy target (% of group)	Adjusted RR (95% CI) <sup>a</sup>
Educational attainment before weeks of pregnancy			
Did not achieve 5 A*–C GCSEs	17,245 (63.0)	10,200 (59.1)	1.00 (ref)
Achieved 5 A*–C GCSEs	3560 (13.0)	2200 (61.8)	1.03 (1.01 to 1.06)
Too young for GCSEs	3825 (14.0)	2535 (66.3)	1.05 (1.01 to 1.09)
CiN status at enrolment	1630 (6.0)	1185 (72.7)	1.18 (1.14 to 1.21)
CPP at enrolment	780 (2.9)	590 (75.6)	1.20 (1.14 to 1.26)
% of visits with partner present, median (IQR)	13 (2–34.4)	14.3 (2.5–35.7)	1.00 (1.00 to 1.00)
IMD 2015 quintiles (LA level)			
Least deprived	6875 (25.1)	4025 (58.5)	1.00 (ref)
2	6845 (25.0)	4115 (60.1)	1.01 (0.94 to 1.08)
3	4625 (16.9)	2855 (61.7)	1.05 (0.98 to 1.12)
4	5945 (21.7)	3560 (59.9)	1.02 (0.94 to 1.09)
Most deprived	3070 (11.2)	2050 (66.8)	1.09 (1.02 to 1.17)

IQR, interquartile range.

a Adjusted models included all variables in the table, which were selected using forward stepwise regression.

b Includes only mothers aged 19 at LMP.

### Notes

Numbers have been rounded to the nearest 5, and cell sizes < 10 have been suppressed, in accordance with NHS Digital's and DfE's statistical disclosure rules for subnational analyses.

Year of delivery is reported in [Table 60](#).

**TABLE 15** Infancy targets: maternal, programme and area-level characteristics associated with meeting fidelity targets in infancy, for mothers giving birth between April 2010 and January 2018 aged 13–19 at LMP

	N mothers (% of all mothers)	N who met infancy target (% of group)	Adjusted RR (95% CI) <sup>a</sup>
<b>Total</b>	<b>25,635 (100)</b>	<b>16,845 (65.7)</b>	–
Met pregnancy target			
No	9405 (36.7)	4420 (47.0)	1.00 (ref)
Yes	16,230 (63.3)	12,425 (76.6)	1.56 (1.50 to 1.61)
Maternal age at birth			
13–15	1270 (5.0)	935 (73.6)	1.07 (1.02 to 1.11)
16–17	8695 (33.9)	5730 (65.9)	1.00 (0.98 to 1.03)
18–19	12,760 (49.8)	8330 (65.3)	1.00 (ref)
20 <sup>b</sup>	2905 (11.3)	1850 (63.7)	0.98 (0.95 to 1.01)
History of admissions with diagnoses within 2 years prior to 20 weeks of pregnancy			
Chronic condition (any, exc. mental health)	3295 (12.9)	2285 (69.3)	1.02 (1.00 to 1.05)
Repeated A&E visits	5490 (21.4)	3720 (67.8)	1.04 (1.01 to 1.06)
Ever in care prior to weeks of pregnancy	2535 (9.9)	1810 (71.4)	1.05 (1.01 to 1.08)
Ever had recorded CPP prior to 20 weeks of pregnancy	1390 (5.4)	990 (71.2)	1.03 (1.00 to 1.07)
Ever recorded as having SEN prior to 20 weeks of pregnancy	13,950 (54.4)	9365 (67.1)	1.04 (1.02 to 1.06)

**TABLE 15** Infancy targets: Maternal, programme and area-level characteristics associated with meeting fidelity targets in infancy, for mothers giving birth between April 2010 and January 2018 aged 13–19 at LMP (*continued*)

	<b>N mothers (% of all mothers)</b>	<b>N who met infancy target (% of group)</b>	<b>Adjusted RR (95% CI)<sup>a</sup></b>
Ever excluded, in PRU or alternative provision prior to 20 weeks of pregnancy	8545 (33.3)	5565 (65.1)	0.97 (0.95 to 0.99)
Ever recorded as persistently absent in a term prior to 20 weeks of pregnancy	12,585 (49.1)	8260 (65.6)	0.97 (0.95 to 0.99)
Educational attainment before 20 weeks of pregnancy			
Attempted but did not achieve 5 A*–C GCSEs	16,115 (62.9)	10,480 (65.0)	1.00 (ref)
Gained 5 A*–C GCSEs	3310 (12.9)	2215 (66.9)	1.03 (1.00 to 1.05)
Too young for GCSEs	3645 (14.2)	2510 (68.9)	1.01 (0.98 to 1.04)
CiN at enrolment	1560 (6.1)	1165 (74.7)	1.08 (1.04 to 1.11)
CPP at enrolment	755 (2.9)	595 (78.8)	1.11 (1.07 to 1.17)
% of visits with partner present, median (IQR)	13.3 (2.4–34.1)	14.3 (3.2–35.3)	1.00 (1.00 to 1.00)
IMD 2015 quintiles (LA level)			
Least deprived	6440 (25.1)	3925 (60.9)	1.00 (ref)
2	6385 (24.9)	4100 (64.2)	1.03 (0.97 to 1.09)
3	4365 (17.0)	2925 (67.0)	1.07 (1.00 to 1.14)
4	5570 (21.7)	3755 (67.4)	1.06 (1.00 to 1.12)
Most deprived	2870 (11.2)	2140 (74.6)	1.09 (1.01 to 1.17)

IQR, interquartile range.

a Adjusted models include all variables in the table, which were selected using forward stepwise regression.

b Includes only mothers aged 19 at LMP.

**Note**

Numbers have been rounded to the nearest 5, and cell sizes &lt; 10 have been suppressed, in accordance with NHS Digital's and DfE's statistical disclosure rules for subnational analyses.

**TABLE 16** Toddlerhood targets: maternal, programme and area-level characteristics associated with meeting fidelity targets in toddlerhood, for mothers giving birth between April 2010 and January 2018 aged 13–19 at LMP

	<b>N mothers (% of all mothers)</b>	<b>N who met toddlerhood target (% of group)</b>	<b>Adjusted RR (95% CI)<sup>a</sup></b>
<b>Total</b>	<b>19,655 (100)</b>	<b>11,900 (60.5)</b>	<b>-</b>
Met pregnancy target			
No	6835 (34.8)	3300 (48.3)	1.00 (ref)
Yes	12,820 (65.2)	8600 (67.1)	1.16 (1.13 to 1.19)
Met infancy target			
No	5805 (29.5)	1945 (33.5)	1.00 (ref)
Yes	13,850 (70.5)	9955 (71.9)	1.98 (1.90 to 2.07)
Ethnicity			
White	16,610 (84.5)	10,235 (61.6)	1.00 (ref)

continued



## RESULTS

**TABLE 16** Toddlerhood targets: Maternal, programme and area-level characteristics associated with meeting fidelity targets in toddlerhood, for mothers giving birth between April 2010 and January 2018 aged 13–19 at LMP (continued)

	<b>N mothers (% of all mothers)</b>	<b>N who met toddlerhood target (% of group)</b>	<b>Adjusted RR (95% CI)<sup>a</sup></b>
South Asian	410 (2.1)	255 (62.2)	1.01 (0.94 to 1.08)
Black	950 (4.8)	470 (49.5)	0.88 (0.81 to 0.94)
Mixed/other	1035 (5.3)	550 (53.1)	0.91 (0.85 to 0.97)
Unknown	645 (3.3)	390 (60.5)	1.01 (0.95 to 1.07)
Repeated A&E visits within 2 years prior to 20 weeks of pregnancy	4015 (20.4)	2530 (63.0)	1.05 (1.03 to 1.07)
Ever recorded as having SEN prior to 20 weeks of pregnancy	10,560 (53.7)	6520 (61.7)	1.04 (1.01 to 1.07)
Ever recorded as having FSM prior to 20 weeks of pregnancy	11,340 (57.7)	6950 (61.3)	1.05 (1.03 to 1.08)
Ever recorded as persistently absent in a term prior to 20 weeks of pregnancy	9745 (49.6)	5880 (60.3)	0.98 (0.96 to 1.00)
Number of benefits received at enrolment			
0	11,115 (56.6)	6525 (58.7)	1.00 (ref)
1	4350 (22.1)	2755 (63.3)	1.04 (1.02 to 1.07)
2	2400 (12.2)	1470 (61.3)	1.01 (0.98 to 1.04)
3	1305 (6.6)	840 (64.4)	1.05 (1.01 to 1.10)
4 +	485 (2.5)	315 (64.9)	1.04 (0.98 to 1.10)
% of visits with partner present, median (IQR)	13.8 (3–33.3)	15 (3.8–35)	1.00 (1.00–1.00)

IQR, interquartile range.

<sup>a</sup> Adjusted models include all variables in the table, which were selected using forward stepwise regression.

### Note

Numbers have been rounded to the nearest 5, and cell sizes < 10 have been suppressed, in accordance with NHS Digital's and DfE's statistical disclosure rules for subnational analyses.

**TABLE 17** Adjusted RRs and 95% CIs comparing outcomes for mothers who achieved fidelity targets at each stage of the programme with those who did not achieve the fidelity targets in that stage, for births between April 2010 and January 2018 to mothers aged 13–19 at LMP

	<b>Child unplanned hospital admissions for maltreatment/injury up to age 2</b>	<b>Good Level of Development (school readiness)</b>	<b>Maternal unplanned admissions for any diagnosis in the 2 years following birth</b>	<b>Subsequent live births within 18 months of the index child</b>
	<b>RR (95% CI)</b>	<b>RR (95% CI)</b>	<b>RR (95% CI)</b>	<b>RR (95% CI)</b>
Met target in pregnancy (80%)	0.90 (0.90 to 1.03)	0.97 (0.92 to 1.02)	1.00 (0.94 to 1.06)	0.87 (0.78 to 0.97)
Met target in infancy (65%)	1.27 (1.12 to 1.43)	0.98 (0.93 to 1.04)	1.02 (0.94 to 1.10)	0.90 (0.79 to 1.03)
Met target in toddlerhood (60%)	1.21 (1.09 to 1.35)	0.98 (0.92 to 1.04)	1.00 (0.94 to 1.07)	0.97 (0.82 to 1.14)

### Note

Relative risks are adjusted for all covariates associated with meeting the target in each stage of the programme and with outcomes.

## Chapter 4 Discussion and implications of evaluation findings

Parts of this chapter have been reproduced from the published papers by Cavallaro *et al.*,<sup>1</sup> Cavallaro *et al.*<sup>2</sup> and Cavallaro *et al.*<sup>101</sup> These are open-access articles distributed in accordance with the Creative Commons Attribution 4.0 Unported (CC BY 4.0) licence, which permits others to copy, redistribute, remix, transform and build upon this work for any purpose, provided the original work is properly cited, a link to the licence is given and an indication of whether changes were made. See: <http://creativecommons.org/licenses/by/4.0/>.

### Chapter outline

This chapter brings together the findings from the three objectives of this study in order to provide an understanding of the context in which the FNP has been delivered over the past decade in England and to summarise our findings on the real-world implementation of the programme and the factors that may influence effectiveness.

For each objective, we summarise the main results, compare these with previous literature and discuss the implications of our findings. Where relevant, we report initial findings from a qualitative analysis of the FNP (see [Qualitative analysis](#)). We then explore the strengths and limitations of the study as a whole. Lastly, we suggest recommendations for policy and practice and further research.

### Objective 1 – which groups of adolescent mothers receive Family Nurse Partnership across local authorities?

While eligibility criteria suggest all first-time adolescent mothers are eligible for the FNP, the service has been rationed to ~ 25–30% of adolescent mothers since the rollout in 2010, as sufficient funding for all was not made available.<sup>102</sup> To inform commissioning and targeting of the FNP, we quantified the variation in enrolment rates across 122 FNP sites in England, comparing maternal vulnerability indicators between eligible mothers who were and were not enrolled in FNP and evaluating site characteristics associated with enrolment.

#### Summary of main results

This study fills an important evidence gap in coverage and targeting of intensive home-visiting services such as FNP within England. We show the most vulnerable mothers are being targeted for FNP, especially the youngest adolescents and those with prior contact with children's social care. However, our findings indicate insufficient commissioning of FNP relative to local needs: only 23% of eligible mothers in FNP catchment areas were enrolled (2010–7), and areas with the greatest numbers of adolescent mothers had lower enrolment rates. Overall, 26% of eligible mothers aged 13–19 with vulnerability markers associated with adverse outcomes were enrolled, including 52% of those aged 13–15, 44% of those ever recorded as being Looked After and 40% of those with prior mental health- or adversity-related hospital admissions. These groups represent mothers and infants at significantly greater risk of low birthweight, unplanned hospital admissions for injury and infant mortality.<sup>89</sup> We did not find any differences in the populations of mothers in areas that did and did not commission FNP.

#### Comparison with existing evidence

To our knowledge, this is the first study examining enrolment in a targeted intensive home-visiting programme for expectant mothers. Two previous studies have shown high variation in acceptance rates for universal home visiting between sites, with higher acceptance rates among higher-risk mothers.<sup>103,104</sup>

In a similar targeted home-visiting intervention for vulnerable families in Canada (Families First), unenrolled mothers were more vulnerable than enrolled mothers – contrary to our findings – illustrating that it can be difficult to enrol the most vulnerable groups.<sup>105</sup>

### **Interpretation**

Budget cuts since the inception of the FNP in England in 2007 mean that the programme, costing approximately £3000 per client per year, has been offered to a more select group of mothers over time.<sup>80,106</sup> This study demonstrates FNP places are not commissioned proportionately to the number of adolescent mothers within local areas, contrary to the stated aims of prioritising ‘areas with [...] the highest numbers of eligible population’.<sup>107</sup> Pregnant adolescents living in areas with many adolescent mothers are less likely to receive support than those in areas with few adolescent mothers, with important implications for equity.

Young age is the main eligibility criterion for FNP in England, based on ease of identification, associations with social adversity, disrupted education and employment<sup>13,61</sup> and other factors contributing to poor health outcomes among their children.<sup>5,6,62</sup> Unlike some other countries, FNP eligibility criteria in England do not include low educational level or unemployment,<sup>27,35,64</sup> which is informed by evidence of higher effectiveness in socioeconomically deprived groups in the US.<sup>32,36,38</sup> In our analysis, only half of mothers aged 13–15 living in areas in which FNP was commissioned were enrolled. Given strict caseload limits (maximum 25 mothers per Family Nurse), many sites in England have explicit policies of prioritising younger adolescent mothers. Overall, 74% of eligible mothers with vulnerability markers were not enrolled in FNP, indicating opportunities for improving policy and commissioning to address vulnerable mothers’ needs, with important and unexplained variation in who is offered intensive services across England.

There are several explanations and implications of this. First, FNP teams may prioritise mothers with additional vulnerabilities not captured in administrative data we used (homelessness or community mental health service use; [Box 1](#)), but it is likely that family nurses do not have the full picture of family vulnerability when prioritising services, and some vulnerabilities (such as family violence) may be disclosed only after a trusting relationship is built with their family nurse or health visitor.<sup>108–110</sup> This underscores the need for effective universal services which can identify those at greatest need for intensive services.

Second, there is uncertainty regarding which vulnerable mothers are most likely to accept and benefit from intensive support. Given insufficient funding to offer the programme to all eligible mothers, family nurses and referring providers need standardised, real-time information on vulnerabilities for all mothers to support decision-making and better target the FNP, alongside effective communication between health visitors and family nurses. Ongoing work on defining vulnerabilities by the FNP National Unit will support sites to determine priority criteria for their local context.

Third, vulnerable mothers may have higher refusal rates. Although FNP’s fidelity target is to enrol 75% of mothers offered FNP, aggregate site data suggest not all sites meet this target. We were unable to determine whether under-representation of some groups, for example, South Asian adolescent mothers, was because they were less likely to be offered a place to accept it or both. FNP teams report that most mothers who decline feel socially well-supported, although some decliners are especially vulnerable (e.g. involved with social care services).<sup>111</sup> Last, more vulnerable mothers may be unknown to midwifery services due to presenting to a booking appointment after 28 weeks (or because of moves between LAs in pregnancy). Individual-level information on who is approached and who accepts would help inform strategies to increase uptake among especially vulnerable mothers.

**BOX 1** Findings from qualitative analysis on the themes of 'Persistence', 'Acceptance' and 'Dedication'**Persistence**

Betsy and Carol reported that persistence is vital in order to recruit the young women onto the programme and to keep them involved; '[y]ou need to be really tenacious and keep trying to engage them'. Betsy recognises that the 'young people ... are very mistrusting a lot of the time [because] they've been let down so many times in their lives'.

Annie was hesitant to engage with the FNP programme at first. 'I ignored all her phone calls, all her text messages ... she must have tried to contact me in excess of 20 times'. Nevertheless, the FNP nurse was persistent, and she was creative in offering Annie different options for appointments, including meeting Annie at work. This was important for Annie due to her past experiences with practitioners. Annie reported that practitioners either 'dabble a little bit and then they leave again' or when 'you miss a couple of appointments ... then no one ever, sort of, comes back'.

Equally, Betsy is improving the referrals process and the service through her own persistence with external organisations: 'We needed to really market FNP as much as possible, so we did lots and lots of presentations with midwives [and] social workers'.

**Acceptance**

There is an acceptance from Betsy and Carol that the system within which they are working is imperfect. Their comments are indicative of a service where there is an increasing number of young people who require support; and where there are increasing numbers of children with a CPP or a CiN plan.

Betsy reported that when she is triaging young parents to provide them with a FNP nurse '[t]here'll be lots of information that you can't see but there has to be some kind of threshold that we use'. This is because 'I only have what I have'. Claire said: 'I think it's just as it happens. I think I just got the highest [number of children on child protection and child in need plans] at the moment ... but ... it, kind of, goes up and down...'

**Dedication**

Betsy is dedicated to the programme and her staff. She reported that choosing who will receive support is 'a big responsibility ... and sometimes you, you have to just choose one'. The repetition of 'who do I, who do I, choose' and 'so that's a, that's a difficult, that's a difficult choice to make' demonstrates her dedication to the young parents in the programme.

**Objective 2 - what is the effect of Family Nurse Partnership enrolment on maternal and child outcomes?**

For this objective, we aimed to determine the effect of the FNP on maternal and child outcomes, including identifying which families benefit the most from the FNP.

**Summary of main results****Cohort description**

We identified a number of pre-pregnancy maternal risk factors for indicators of child maltreatment, including younger maternal age, living in more deprived areas, having a history of adversity- or mental health-related hospital admissions, having later first contact with antenatal services, having been referred to social care services as a child, having SEN provision, being persistently absent from school or excluded and having lower educational attainment. Our findings add to previous research that describes the association between having a history of adversity- or mental health-related hospital admissions and increased hospital admissions in infancy by linking additional maternal data on education and social care risk factors and identifying novel risk factors that are important for first-time adolescent mothers.<sup>89</sup>

Some of the most important risk factors for child maltreatment in this population are maternal histories of being in care or being excluded from school.

Mothers enrolled in the FNP were much more likely to have these risk factors than those who were not enrolled, and FNP enrolment therefore works as a composite indicator of vulnerability.

### Indicators of child maltreatment

There was no difference in CiN or CLA according to enrolment in the FNP, but there was weak evidence that FNP was associated with a reduction in the percentage of children with a CPP (RR 0.84, 95% CI 0.71 to 1.00;  $p$ -value = 0.049). We saw an increased risk of unplanned admissions for maltreatment/injury in the 2 years after birth in children born to mothers enrolled in FNP (RR 1.15, 95% CI 1.07 to 1.24, compared to children born to mothers not enrolled in FNP), which did not persist at 7 years after birth.

### Other child health/development/education outcomes

We found that FNP was associated with an increase in the number of children with  $\geq 1$  unplanned admission for any diagnosis up to age 2 and the number of children with  $\geq 1$  A&E attendance by age 2 and 7. We also found evidence of a small increase in children achieving a Good Level of Development (school readiness) at age 5 in the FNP group (RR 1.05, 95% CI 1.01 to 1.09;  $p$ -value = 0.031). There was no evidence that this advantage persisted at Key Stage 1, nor was there any evidence of a difference between groups in SEN provision. FNP was also associated with an increase in the percentage of children registered for FSM (RR 1.09, 95% CI 1.04 to 1.14).

### Maternal outcomes

Mothers who were enrolled in the FNP were less likely to have a rapid repeat pregnancy resulting in a subsequent birth within 18 months of the index birth (RR 0.83, 95% CI 0.88 to 0.97). This association varied by region, with strongest associations seen in the South-East, South-West and London. There was no evidence of a difference between groups in the numbers of mothers obtaining 5 A\*–C equivalents, including Maths and English at GCSE level or in school enrolment following birth.

Mothers enrolled in the FNP were more likely to have an unplanned admission to hospital for diagnoses relating to adversity (substance misuse, self-harm or violence) or mental health conditions than those who were not enrolled. This association persisted until 7 years following delivery, though the size of the association decreased over time.

### Comparison with existing evidence

We were able to use data for almost all eligible mothers ever enrolled in the FNP since 2010 in England, excluding 1360 mothers who did not agree for their data to be used for research. Although we cannot know what the characteristics of the declining mothers are, the high coverage of our cohort means that our results are likely highly generalisable to the eligible population. We were able to link 99% of FNP mothers to a health record, and 98% of these to their baby's health record.

Linked education data were available for 83% of mothers aged 13–19 (who were born between 1991 and 2006). These linkage rates are similar to those of other studies linking with NPD: 83% of Millennium Cohort Study children (born 2000–1) and 85% of Case Register Interactive Search Child and Adolescent Mental Health children (CRIS CAMHS, children referred between 2008 and 2013) were linked to the NPD.<sup>112</sup> In the study, mothers who could not be linked to NPD were more likely to be older, less likely to be white, more likely to be living in the most deprived areas and less likely to have had hospital admissions in the 2 years prior to 20 weeks of pregnancy. Similar differences in the characteristics of linked and unlinked individuals have been observed in another evaluation of linkage between HES and NPD, which found that the most deprived pupils and those in ethnic minority groups were less likely to link.<sup>71</sup> Such differential linkage is widespread and represents a problem of inequality, whereby particular groups and ethnicities are excluded from research based on analyses of linked administrative data or are less likely to link to information on risk factors or outcomes, meaning they are more likely to have their needs underestimated.<sup>113</sup>

Numbers of children classified as CiN in our cohort (22%) was similar to those observed in the Building Blocks trial, which found that 21.5% of children were ever classified as CiN. Since we cannot identify children who were in contact with children's social care services only before school entry (due to the way in which identifiers are assigned in the DfE data), these estimates likely underestimate true numbers of referrals. Other studies have shown that a large proportion of CiN occurs in preschool children: based on information from a Freedom of Information request, Bilson *et al.* estimated that 14% of children born between 2009 and 2010 were CiN before their fifth birthday.<sup>114</sup> Based on model estimates using data from the NPD, Jay *et al.* estimate that 25% of children are ever classed as CiN before age 16.<sup>115</sup>

Rates of CPPs were lower in our cohort (4.5% overall and 5.1% in the FNP group) than in the Building Blocks trial (6.8% in the FNP arm and 6.6% in the usual care arm), and rates of CLA were also lower (2.0% in our cohort overall and 2.6% in the FNP group compared with 3.6% in the FNP arm and 3.3% in the usual care arm of the trial). Numbers of CLA in our study population were higher than those observed in the general population, including children born to older mothers. For example, a study of the cumulative incidence of CLA using NPD data found that 1.5% of children born in 2004–6 were ever Looked After by age 6, with increasing rates over time.<sup>78</sup> This may be due to the inclusion of all children recorded as CLA in our data, irrespective of the primary need code.

Our findings of no difference in CiN or CLA between groups mirror those of the Building Blocks 2–6 evaluation, which also found no difference in the timing or first referral, duration or primary need for CiN.<sup>24</sup> The Building Blocks evaluation did find that CLA in the FNP arm were in care for a shorter period of time compared with children in the usual care arm. We did not evaluate duration of periods of care in this study.

In the study, we found that 75% of children had an unplanned hospital admission or A&E attendance in the 2 years following birth (37% had an unplanned hospital admission and 72% had an A&E attendance). This was comparable to rates seen in the Building Blocks trial, where 81% of the FNP arm and 77% of the usual care arm had an unplanned hospital admission or A&E attendance.<sup>99</sup>

The proportion of children achieving a Good Level of Development (school readiness) in our cohort was 58%, which was the same as reported in the FNP arm of the Building Blocks trial.<sup>24</sup> Percentages of children reaching the expected standard at Key Stage 1 for Reading and Maths were also similar (65% and 63% compared with 65% and 62%, respectively). Key Stage 1 Writing results were less comparable, due in part to increases in rates of children reaching the expected levels over time, as described in detail in the Building Blocks 2–6 report.<sup>24</sup>

Our finding of a reduction in rapid repeat pregnancies in mothers enrolled in the FNP differs to findings from the Building Blocks trial, which observed no evidence of an effect on subsequent pregnancies within 24 months of the first birth. This may in part be due to differences in definitions: we only captured pregnancies that resulted in a live birth (as abortion data were not available and early miscarriages are not well captured in hospital data). We chose the 18-month time period based on evidence that shorter birth-to-pregnancy intervals are associated with the highest risks of adverse outcomes for women and babies and after discussions with our Patient and Public Involvement (PPI) group, who felt that a second birth within 2 years was a positive event for many young mothers.<sup>84</sup> Nevertheless, 17% of mothers had a second child within 24 months in our cohort, compared with 21% of mothers having a repeat pregnancy within 24 months (based on inpatient data only) in the Building Blocks trial.

There are differences in the population of mothers and their social circumstances when enrolling in versions of the FNP that have been implemented in different countries.<sup>22</sup> These differences in underlying risks of maltreatment and in how it is detected and responded to may determine the likelihood that families might benefit from the programme in a particular setting. While there may be benefits in some

settings, our findings support previous results in England of no impact on child maltreatment outcomes, and there is no evidence to suggest that benefits from the FNP will appear as children get older.

### **Interpretation**

We found no evidence of an association between FNP and the majority of the outcomes that we evaluated. Our findings are likely to be affected by residual confounding, whereby mothers enrolled in FNP were at higher risk of adverse outcomes than those who were not enrolled, even when matching on pre-pregnancy health, education and social care characteristics. Where differences between groups were observed, interpretation of outcomes captured in administrative data is challenging and complex.<sup>24</sup> For example, our finding of an increased risk of unplanned admissions for injury/maltreatment in the FNP group could represent more injuries in this group but could also reflect more appropriate care-seeking, particularly for minor injuries. Family nurses encourage mothers to have their child seen by a clinician when necessary, and this is particularly likely to be apparent during the 2-year period in which family nurses are visiting families. We also saw increased rates of A&E attendances, outpatient attendances and unplanned admissions for any reason, which may represent appropriate care-seeking behaviour by parents. However, findings from the Elmira trial of the NFP showed a substantial reduction in visits to the physician for injuries or ingestions and in visits to the emergency department associated with the intervention, which, combined with other findings, was interpreted as reflecting a reduction in underlying maltreatment.<sup>25</sup> Therefore, the increased risk of unplanned admissions for injury/maltreatment in the FNP group in the study could genuinely represent an underlying increased risk of maltreatment. This, in turn, might be due to residual unmeasured confounding since mothers enrolled in FNP had more indicators of adversity than mothers who were not enrolled.

Our finding of weak evidence of a reduction in the number of CPPs associated with FNP (and similar directions of non-significant associations for CiN and CLA) reinforces the complexity of understanding the mechanisms underlying these outcomes. Firstly, this finding should be interpreted with some caution given the borderline *p*-value (0.049) in the context of evaluating a large number of outcomes. Secondly, others have argued that given the ethical, clinical and legal mandate that family nurses have to ensure that children are protected through linkages with appropriate services, increased rates of social care contacts might well be expected in mothers enrolled in the FNP, reflecting earlier and more comprehensive surveillance.<sup>29,116</sup> Family nurses are in a unique position to identify early problems and start processes for safeguarding, which may explain the increased rates of discharge to social services at birth. Indeed, families in the FNP arm of the Building Blocks trial had higher rates of safeguarding procedures noted in the primary care record (13.6%) than families in the usual care arm (8.0%).<sup>99</sup> However, the Building Blocks 2–6 trial found no evidence of surveillance bias when evaluating thresholds for referrals to social care: rates of children who needed no further assessment after being referred were similar between arms.<sup>24</sup> In the study, we measured CiN and CLA in school-age children, who would not have still been seen by the family nurse and who would therefore be less likely to have been affected by surveillance bias.

We observed a higher prevalence of preterm births and low birthweight babies in the FNP group compared with mothers who were not enrolled. These are important birth outcomes, as they are associated with a disproportionate amount of healthcare use (due in part to an increased risk of chronic disease), childhood mortality and poor short- and long-term health and educational outcomes.<sup>117,118</sup> However, the inclusion of low birthweight as one of the primary outcomes of the Building Blocks trial was questioned, as it was not an outcome that the NFP claimed to affect and not one for which previous replicated effects had been observed.<sup>22,23</sup> Home visiting occurs too late to be able to influence preconception health, which is an important predictor of adverse birth outcomes.<sup>119</sup> Indeed, there is little evidence in general for the effect of home visiting on pregnancy outcomes, including from the NFP.<sup>43,120,121</sup> The apparent increased risk of all-cause hospital admissions that we observed in the FNP group may therefore be influenced in part by the higher prevalence of adverse birth outcomes in this group, which are associated with increased unplanned hospital admissions in the first years of life.<sup>122</sup>

Our finding of an association between FNP enrolment and a small increase in the number of children achieving a Good Level of Development (school readiness) at age 5 supports similar findings from the Building Blocks 2–6 trial and fewer maternally reported developmental concerns at age 2 in the FNP arm of the original Building Blocks trial.<sup>24</sup> The Good Level of Development is not particularly sensitive to fine changes as a measure of school readiness, and so the underlying association may be even more substantial.<sup>123</sup> Building Blocks 2–6 also found an effect of FNP on Key Stage 1 outcomes, which was not replicated in this study.

Evidence suggests that a large number of families who meet the criteria for FSM do not apply for the benefit.<sup>124</sup> Our finding that mothers enrolled in the FNP were more likely to have children registered for FSM may therefore indicate that family nurses are able to help mothers access the support that is available to them (which includes needing to claim the underlying welfare benefits that form the basis for FSM eligibility) and to overcome recognised barriers such as inadequate information about the claiming process. FSM eligibility is a robust indicator of social disadvantage, and we show that almost half of children born to adolescent mothers are registered (compared with 14% of children nationally who were in school in 2015–6).<sup>125,126</sup> Given the associations between socioeconomic disadvantage, adolescent motherhood and adverse child outcomes, strategies to address the root causes of social disadvantage are also required in order to reduce inequalities and improve outcomes for mothers and their children.

Despite controlling for higher rates of pre-pregnancy unplanned admissions to hospital for diagnoses relating to adversity (substance misuse, self-harm or violence) or mental health conditions in mothers enrolled in FNP, we found that this group continued to have higher rates of these admissions, and A&E attendances, in the 2 and 7 years after giving birth. Part of this may be due to increased self-reflection and self-efficacy as a result of the programme: family nurses work with mothers to explore the trauma that many of them have experienced in the past and to become more insightful about their own needs. Cuts to mental health services have made making appropriate referrals difficult, which may lead to mothers ending up in A&E. We could only measure the most severe problems, as we only identified cases that resulted in a hospital admission record. We did not have data on primary care, which could have provided more information on outcomes that were not severe enough to result in a hospital admission. In our cohort as a whole, 6% of mothers had an unplanned admission to hospital for adversity-related diagnoses, and 8% of mothers had an unplanned admission for mental health-related diagnoses in the 7 years following delivery. Capturing measures of domestic violence is challenging, as mothers may choose not to report violence for fear that a child may be taken away or only make disclosures after a trusting relationship is built with their family nurse or health visitor.<sup>108–110</sup> We are therefore likely to have underestimated the extent of these conditions, meaning that there are many more mothers who are in need of continued support for their health after birth. Others have argued the importance of taking a long-term view of the health of vulnerable mothers, and our findings highlight that vulnerable mothers as well as their children continue to need support for many years after giving birth.<sup>127</sup>

Of the younger mothers in our cohort who had not completed their education before becoming pregnant, 10% were able to go on to achieve 5 A\*–C grades at GCSE level. While these rates are lower than national figures (around 60%), this still represents a substantial achievement for young mothers who are balancing the responsibilities of caring for a new baby and studying for their exams. However, these findings highlight the structural barriers and challenges that adolescent mothers will face as they become young adults and move into the world of employment. More needs to be done to halt this cycle of poverty and income inequality and to improve the life chances of young mothers.<sup>5</sup>

Our finding of a reduction in the number of subsequent deliveries within 18 months should be interpreted cautiously. As we could not measure abortions or miscarriages in this study, we do not know how many mothers in each group became pregnant but chose, or were unable, to continue their pregnancy. However, birth spacing is key for both promoting maternal education and engagement in the workforce and preventing harm to the mother and child, and we show that it may be possible



for the programme to influence birth spacing and therefore the maternal life course. This is an important finding: national surveys in England have shown that only 12% of pregnancies in mothers aged 16–19 are planned, highlighting the need for primary prevention strategies to avoid unwanted pregnancies.<sup>128</sup> Previous research has also shown that the effects of adolescent motherhood persist for previous adolescent mothers giving birth again in their 20s, meaning that strategies to improve the life changes of reproductive choices for young women about the timing of their pregnancies could have lasting effects.<sup>12</sup>

### **Objective 3 – what contextual and programme factors influence the effect of Family Nurse Partnership?**

For this objective, we aimed to identify contextual and programme factors that might influence FNP programme effect.

#### ***Summary of main results and comparison with previous evidence***

Overall, 58% of mothers enrolled in the FNP giving birth between April 2010 and January 2018 completed the programme, and 42% left early. Compared with targets, attrition was slightly lower in pregnancy (8%) but higher in infancy (23%) and toddlerhood (19%). These attrition rates are also higher than were observed in the Building Blocks trial (4% in pregnancy, 10% in infancy and 8% in toddlerhood), possibly reflecting a trial effect whereby FNP nurses involved in the trial might have felt more expectation to retain mothers in the programme. Alternatively, this could reflect changes in practice over time and increased flexibility in recent years, allowing mothers to leave the programme early.

The mean number of visits received by mothers across the programme was 36 (median 38). This is similar to that reported in Building Blocks (mean = 39 visits). Across the programme stages, the median number of visits was 10 in pregnancy, 10 in infancy and 14 in toddlerhood, compared with 10, 19 and 13, respectively, in Building Blocks. Overall, mothers enrolled in FNP received an average of 42 hours of contact time with a family nurse throughout the programme.

Approximately 60% of mothers met the fidelity targets for the number of completed visits in pregnancy, 65% in infancy and 60% in toddlerhood. This was slightly higher than fidelity targets reported in the Building Blocks trial, which reported 58% in pregnancy, 53% in infancy and 44% in toddlerhood. This may be due to differences in the way that the expected number of visits was calculated in each study, taking into account the time period in which a mother was enrolled (and therefore the number of visits for which she could possibly receive).

Overall, only 28% of mothers met the fidelity targets across all stages of the programme. This could reflect an unrealistic time commitment for mothers or practical problems in arranging visits to suit both mothers and nurses (who have maximum caseloads of 25 mothers). Following the publication of the Building Blocks trial and qualitative research suggesting that mothers wanted more flexibility within the programme, the FNP National Unit made the decision to allow greater flexibility in the appropriate number of visits per mother, which is now decided locally ('dialling up' or 'dialling down' according to a nurse-client assessment of need), along with the optimal time for graduation.<sup>129,130</sup> It is not yet clear how these recent changes to the programme will impact longer-term outcomes: more information on why a mother leaves the programme is needed to evaluate these changes.

We show that the most vulnerable and youngest mothers tended to have greater numbers of visits and were more likely to meet the fidelity targets than those who did not have these risk factors. After adjusting for these characteristics, mothers who met the target for the number of expected visits in pregnancy were less likely to have a subsequent birth within 18 months than those who did not meet the target; children born to mothers who met the target in infancy and toddlerhood were more likely to have unplanned hospital admissions for maltreatment/injury up to age 2 than those who did not meet the targets in these stages.

### Interpretation

Our finding that the most vulnerable and youngest mothers received a greater dosage of visits and were more likely to meet fidelity targets than those who did not have these risk factors suggests that even before the introduction of the Accelerated Design and Programme Testing (ADAPT) sites, family nurses were making decisions about where to prioritise their time and resources and were able to provide more intensive support to those they felt most needed it. These findings make evaluating the impact of dosage of the FNP problematic since the most vulnerable mothers receive more visits but are also independently more likely to experience worse outcomes. However, our findings for unplanned hospital admissions for maltreatment/injury and subsequent births mirror those of Objective 2 comparing mothers enrolled or not enrolled in FNP: mothers who had more visits were more likely to have children with unplanned hospital admissions for maltreatment/injury up to age 2 but less likely to have a subsequent pregnancy within 18 months. For a Good Level of Development and maternal hospital admissions, we found no evidence of a difference in outcomes for mothers who met the fidelity targets and those who did not. An experimental design, combined with more detailed information on why mothers leave the programme, could be used to further evaluate the impact of the number of visits on outcomes. This may be especially relevant in the context of limited resources and previous evidence suggesting that 'less is more' for interventions aiming to enhance parental sensitivity and promote attachment.<sup>131</sup>

Findings from the qualitative analysis emphasise that the length of the programme is important to both mothers and Family Nurses (Box 2).

#### BOX 2 Findings from qualitative analysis on the themes of 'Time'

##### Time

The reason that the programme commences at 16 weeks' gestation and ceases when the child is 2 years old is because the FNP nurses get to know their clients well which is essential in 'affect[ing] change' – Betsy.

The length of the programme was important for Annie because it enabled her to develop a trusting relationship with her FNP nurse: 'It was lovely to be able to have that relationship with someone, you know, always, someone that I could text or call if I needed to'. However, it was difficult when the support came to end: 'I cried so much when I said goodbye [to the FNP nurse]'.

Nevertheless, the duration of the programme '... can be really, really frustrating when there's suddenly poor engagement [from parents]' – Betsy.

## Strengths and limitations

### Strengths

A major strength of this study was the use of a population-based cohort of all first-time adolescent mothers giving birth in English NHS hospitals, linked to routine education and social care records. This provided us with a large sample size for analysing subgroups and increased statistical power for detecting small differences. Linking 99% of FNP mothers to HES gave us a highly generalisable cohort of FNP mothers enrolled between April 2010 and March 2019. Using propensity scores derived from observed data on maternal histories recorded in health, education and social care data, we were able to create closely matched groups for > 95% of the FNP mothers in our cohort. The unmatched mothers were captured in a sensitivity analysis using matching with replacement and in the multivariable regression analysis.

Another strength was our use of objective measures of indicators of maltreatment and child development. However, these blunt measures could be supplemented by multimethod approaches in order to give a more nuanced interpretation of outcomes, as is being done for the evaluation of the German Pro Kind intervention, which will use a combination of interviews, observations and administrative data.<sup>132</sup> We also spent a significant amount of time talking to FNP teams, including

observing a home visit, in order to understand the perspectives of family nurses and the mothers and families they represent. This enhanced our ability to interpret the results we observed in the data.

### Limitations

The potential sources of bias and the steps we took to try to minimise these are summarised in [Table 18](#) and the following sections.

#### Indication bias due to unmeasured confounders

The main limitation of our analyses was that the administrative data we used did not capture information on all relevant maternal characteristics associated with enrolment, and there were important differences in the characteristics of mothers enrolled in FNP and those who were not, meaning that mothers enrolled in FNP were more vulnerable than the comparison group. For some outcomes, including a Good Level of Development, the findings in the propensity-score-matched cohort reversed those of the unadjusted comparison: while the crude analysis of this outcome showed lower rates in mothers enrolled in FNP, the adjusted comparisons showed higher rates. This suggests that the propensity score matching (and multivariable regression analyses) was able to account for some confounders. However, the higher rates of low birthweight and maternal unplanned admissions after birth in the FNP arm could indicate that residual confounding remains.

**TABLE 18** Potential sources of bias in the evaluations of the Family Nurse Partnership in England using linked administrative data and information needed to assess their likely extent

Bias	Description	Impact on effect estimates
Indication bias due to FNP nurses deciding which mothers to approach (unmeasured confounding)	Family nurses prioritise the more vulnerable mothers among those meeting eligibility criteria, and so those enrolled may have been more likely than those not enrolled to experience adverse outcomes.	Underestimation of the effect of the intervention.
Misclassification bias of eligibility for FNP	In analyses, mothers may have been assigned to different groups than the ones they should be in because eligibility was incorrectly defined.	Bias in either/both directions: random misclassification is likely to underestimate the intervention effect, but bias in misclassification may under or overestimate intervention effect.
Consent bias for enrolment in FNP	Mothers who were offered the intervention but who declined may have been different to those who were not offered the intervention.	Bias in either/both directions. Those who were offered the intervention but who declined may be a mixture of the most vulnerable and the least vulnerable mothers.
Linkage bias	Linkage error (e.g. missed links or false links <sup>a</sup> ) could mean that subgroups of the population were differentially excluded from the analysis cohort or had missing data on variables obtained through linkage. Missed links can also lead to misclassification bias (see above).	Bias in either/both directions. It is difficult to ascertain the direction of effect, particularly when there are multiple complex linkages and when the impact of linkage errors works in opposite directions.
Measurement bias	Usual care for mothers not enrolled was not captured; surveillance bias might mean that problems in the FNP group were more likely to be detected.	Bias in either direction. Mothers not enrolled in FNP may have had more/less health visiting contacts than usual; FNP nurses may have been more likely to pick up on areas of need (ascertainment/surveillance bias).

<sup>a</sup> Missed links occur when a mother in the FNP IS data are not linked to her health/education record and therefore appears twice in the data – once as a FNP mother with no linked health/education data and once in the health data as being a mother who was not enrolled in the FNP; false links are likely to be less common and occur when a FNP record is linked to the wrong health/education record, causing a mother not enrolled in the FNP to appear as though she was enrolled.

Although we used a large number of pre-enrolment maternal characteristics from health, education and social care data for our propensity score matching, it was only possible to evaluate the balance between propensity score-matched groups in terms of these measured characteristics. For measured characteristics, we can only know if groups were balanced on the presence of a characteristic (e.g. a history of hospital admissions for adversity) but not on the nature or severity of that characteristic. This means that although the groups looked comparable in terms of measured characteristics, we likely did not fully account for important unmeasured differences between those that did and did not receive FNP: a phenomenon known as the treatment paradox.<sup>133</sup> For example, some important vulnerabilities (such as family violence) may not be disclosed until a trusting relationship has been built with providers and may not be captured in administrative data at all.<sup>109,110,134</sup> Our approach was restricted by data that were systematically collected by services and the quality of recording of that data.

### **Characterising usual care provided to mothers not enrolled in Family Nurse Partnership**

Usual care for adolescent mothers differs substantially between LAs and over time (including varying numbers of health visitor contacts and additional services for adolescent mothers).<sup>135,136</sup> Health visitors are under-resourced, which makes it likely that not all adolescent mothers are receiving the standard of care that should be expected.<sup>65</sup> Although national data on health visiting are collected, this is not yet well completed nor disaggregated by maternal age.<sup>137-139</sup> We did not have any information on midwifery care and therefore were unable to identify areas in which mothers received care from specialist teenage pregnancy midwives. Bespoke data collection was not feasible within the timeframe of this study; we were therefore unable to include a quantitative measure of usual care in our models, limiting the precision of our intervention effect estimates.

We did not have access to information on additional services that mothers might have accessed as a result of interactions with the family nurse, including, for example, housing services. If mothers not enrolled in FNP had access to high levels of support from other teams in the community, it may be difficult to identify an incremental effect on outcomes for those enrolled in FNP.<sup>23</sup>

### **Misclassification bias (defining our intervention and comparison groups)**

In order to make comparisons with mothers who had not been enrolled in FNP but who were eligible, we needed to define the population of adolescent mothers who would have been eligible for the FNP but who were not enrolled due to living in an area in which the FNP was not offered at the time of their pregnancy. If information on recruitment dates was inaccurate, misclassification bias could occur if mothers were categorised as being eligible for the FNP when they were not or vice versa. Site activity dates and geography were key to defining these populations, but this information was not readily available. FNP sites merged and split over time, site boundaries moved and sites discontinued or joined the FNP at different times.

We used extensive data quality checks for LA-specific site activity dates and geographic coverage with the FNP National Unit to minimise misclassification of unenrolled eligible mothers. However, we may have overestimated unenrolled eligible mothers and therefore underestimated some enrolment rates. Conversely, birth ascertainment in HES (97% of total births in English hospitals according to the ONS)<sup>69</sup> means some mothers may have been wrongly excluded from the denominator. Neither under- nor over-ascertainment of unenrolled eligible mothers is likely to have biased the analysis of predictors of enrolment, since they should not be associated with risk factors.

Missing data on gestational age at booking appointment (32%) and birth (13%) required us to make some assumptions to determine eligibility for the FNP. Some mothers with missing gestational age at first antenatal appointment may have booked after 28 weeks but were retained in our cohort (2.6% were excluded due to known booking appointment after 28 weeks vs. 7% expected based on primary care records – S Syed, personal communication). We cannot know whether the 0.5% of children who were discharged to social services at birth were reunited with their birth mothers; inclusion of these children

in the analysis of outcomes in the 2 and 7 years following birth might have led to a small bias in either direction (as these babies may not have been exposed to their birth mothers during follow-up).

### **Consent bias due to lack of information on mothers who declined the intervention**

It was not possible to identify eligible mothers who were offered enrolment but declined. As a result, these mothers were included in the comparison of mothers who had never been enrolled in the FNP. This could lead to consent bias: if mothers who declined were more vulnerable than those who accepted, it might lead us to underestimate the intervention effect. FNP sites had limited aggregate information on these mothers. Some sites reported that although a small number were particularly vulnerable mothers (e.g. involved with social care services), the majority of mothers who declined were those with strong social support.

### **Missing data due to linkage error**

Eight-three per cent of mothers aged 13–19 in our cohort were linked to NPD. Some unlinked mothers would genuinely not have been captured in NPD due to attending an independent school or a school in a different country. Other mothers may not have been linked due to inconsistencies between identifiers recorded in both data sources. HES records for a small number of FNP mothers who did not link to HES would mistakenly have been treated as belonging to the comparison group, which again may lead to misclassification bias. The extent to which these missed links lead to bias depends on how the unlinked records are dealt with in analysis: in this study, all mothers/babies were retained in the analysis (but we could only measure educational outcomes for those who linked).<sup>140</sup> Determining the potential direction of bias is complex, particularly when successive linkages are performed (such as FNP data linked to health data, then to educational data). We identified groups of mothers who were more at risk of linkage bias or missing data by comparing the characteristics of FNP mothers who did and did not link with HES and NPD records (see [Appendix 2, Tables 24 and 29](#)).

### **Data approval and access delays**

It took 4 years from data applications being submitted to the final linked data set being available for analysis (see [Appendix 10](#)). Lengthy application processes and delays in receiving administrative data have been widely documented elsewhere.<sup>141–144</sup> Cross-sectoral data linkage adds other delays, including in data providers sending identifier information to trusted third parties for linkage and in migrating data to a single trusted research environment. These delays impeded analysis time: linked data were finally available 1 month before our initial grant endpoint, an insufficient period within which to deliver results based on extensive administrative data cleaning, assessment of linkage quality, construction of study cohorts and optimisation of quasi-experimental approaches. This was exacerbated by problems with the secure server on which the data were hosted, which meant that there were many days when the data were not accessible.

### **Other limitations**

We did not consider costs in this study. The Building Blocks trial found that the FNP costed on average an additional £1812 (95% CI –£2814 to £5557) per mother compared to usual care and that there were only minor differences across trial arms, with largest drivers of costs being hospital inpatient stays.<sup>80</sup> Costs associated with the involvement of other professionals interacting with family nurses, education, social care and primary care costs have never been considered.

In our analysis of the number and duration of visits, we did not account for the content or other factors (e.g. continuity of care) that might influence the effectiveness of the programme. We were unable to report on mortality due to discrepancies in recording of deaths between data sources.

Our PPI was limited by difficulties in engaging FNP graduates. Although the participants who attended our focus group were enthusiastic about remaining involved, the practicalities of keeping in touch with

young mothers who have changing priorities over time meant that we struggled to retain mothers through the course of the study. Difficulty in engaging FNP graduates was also described in the Building Blocks 2–6 trial.<sup>24</sup>

We designed the study to describe a wide range of outcomes, due in part to the fact that the primary outcomes specified in the original Building Blocks trial were challenged and to enable us to compare the findings from the study with other evaluations of the FNP.<sup>22,23,116</sup> A limitation of this approach is that the large number of comparisons made could generate spurious results since 1 in 20 findings will be by chance when using 95% CIs. Therefore, the few statistically significant findings that we observed out of the many that were evaluated should be considered in the context of patterns of effect (rather than relying on *p*-values) and the extent to which they align with previous studies.

## Patient and public involvement

In the process of designing the study, we engaged with two groups of mothers (some who had participated in FNP, some who had not). We discussed the use of administrative data for research (including concepts that mothers were not previously familiar with, such as de-identification and data linkage), linkage of health and education data without explicit consent and the use of these data specifically for evaluating the FNP. Workshop participants were supportive of the proposed study and fed back that linking health and education data for mothers and their children was a good idea. Participants strongly agreed with sharing their data so that services could be improved and future mothers could benefit and wanted to know how their data had been used to benefit others. Mothers were strongly supportive of taking into account maternal education and area, and wider family support for the FNP, in order to understand whether the programme worked.<sup>145</sup> We incorporated these opinions into the study plan by planning to evaluate whether the linkage of FNP differs by area and by maternal risk factors.

This Study Steering Committee included a former adolescent mother, who was consulted throughout the study period. When it was not possible for her to attend meetings, we organised separate meetings to present the same findings and discuss progress. Towards the end of the study, our lay member withdrew from being involved in the study due to changes in family circumstances. Our committee also initially included one mother who had completed the FNP but later dropped out. In order to increase the level of involvement in the study, we contacted FNP sites via the FNP National Unit to recruit mothers participating in FNP part way through the study and approached two additional mothers (one current and one former FNP participant), who both agreed to join the study. However, communication was challenging as it was difficult to find a time that fitted their schedule. The former FNP participant eventually contacted us to say she no longer had the time to be involved, and we stopped receiving replies from the current FNP participant (whose baby was very young), reflecting the challenges of effective PPI with this target population.

We ran a training day for parents interested in learning more about administrative data research in October 2019 at Great Ormond Street Hospital, which was well attended by parents. On the training day, we gave an overview of what is meant by administrative data research and data linkage, with examples from specific data sets, including those used in this study (HES). We discussed the appropriateness of linking data on mothers and children for purposes such as this study. Participants were strongly supportive of the data being used in this way and fed back that they found the training extremely useful and interesting.

Parent participants will help coproduce information on the study for the FNP and institutional websites, help with interpretation of results and identify the most appropriate methods of dissemination.

## Equality, diversity and inclusion

This study included all mothers and their children who were ever enrolled in FNP and was therefore representative of the population receiving the intervention. However, we do not have information on the characteristics of mothers who are not approached for or decline to enrol in FNP, and we do not know the extent to which FNP is inclusive of all mothers who stand to benefit. We aimed to fill gaps in evidence on whether the effect of FNP varied across different subgroups and present results of the intervention effect stratified by ethnicity, age and deprivation.

Our research team did not include those from groups who are generally under-represented in our field of study, but there was a range of experience and expertise across the research team. We provided development opportunities for more junior members of the team, including providing opportunities for teaching and supervision experience and supporting a promotion application. We attempted to include members of the public who were representative of the eligible population of adolescent mothers across a geographic range in England, although this proved to be challenging in practice.

## Conclusions

Our findings support previous evaluations of FNP in England, which show no impact on child maltreatment outcomes and no evidence to suggest that further benefits will appear as children get older but are in contrast to qualitative research describing the positive impacts of the programme. There remains uncertainty about whether intensive home visiting is effective for reducing child maltreatment because of the potential for bias relating to the selection of the most vulnerable mothers into FNP on the basis of unmeasured characteristics (which could mask beneficial effects), the lack of information about usual care for adolescent mothers not enrolled in FNP (which could introduce bias to the null) and the challenges of interpreting outcomes captured in administrative data. The findings in this report should therefore be interpreted with three main considerations.

First, we could only control for the fairly crude maternal risk factors associated with enrolment in FNP that are captured in administrative data. The increased rates of maternal unplanned admissions post pregnancy for adversity and mental health-related diagnoses in the FNP group could indicate that there may be additional residual confounding due to bias by indication, even after propensity score matching. Given that we know that mothers enrolled in FNP had more indicators of vulnerability at enrolment than the comparison group, such residual confounding could have limited our ability to detect beneficial effects of the programme. The weak evidence for small improvements in school readiness as measured by a Good Level of Development in the EYFSP and reductions in the number of rapid repeat pregnancies may therefore reflect larger positive effects of the programme. However, these outcomes should still be considered in the context of being the only 'positive' effects amongst the many outcomes that were evaluated. The importance of these small effects should be examined alongside other population-level interventions aiming to improve child health and development outcomes.

Second, the increased rates of unplanned admissions and A&E attendances in the mother and child associated with FNP may reflect appropriate care-seeking as a result of advice and support from family nurses rather than residual confounding. Babies born to mothers enrolled in the FNP were more likely to be born preterm and with low birthweight; these are health conditions which are influenced by pre-conception health, and babies with these conditions would be expected to have appropriately increased rates of hospital contacts throughout childhood. Increased rates of admissions in the mother could also be interpreted as demonstrating that family nurses can have a long-term effect on maternal health care-seeking behaviours.

Third, FNP might have positive effects on a range of other outcomes that are not captured in administrative data ([Box 3](#)). This study was not able to identify effects on changes in self-reported

parental mental health, sense of self, well-being, confidence, behaviour and parent–child engagement and interaction, including for fathers. Nuances in behaviour change are difficult to measure: for example, a mother may not give up smoking completely but may change how she smokes by not smoking in the home and not allowing others to smoke in the home. Existing qualitative work demonstrates overwhelming support for the programme from mothers who have been enrolled and from family nurses who can see the changes and impact that the intensive service has provided for the families they have worked with.<sup>99,130</sup> Mothers often stay in touch with their family nurses after graduation and can reflect on how the programme has helped them transition, become confident as a parent, and be a more responsive parent.<sup>130</sup> There have been no dissenting voices as to the overall efficacy of the programme, and each mother reported it had been helpful in some way – either ‘life changing’ or serving to consolidate existing skills and qualities.<sup>99</sup> However, there is a lack of conclusive, systematic evidence supporting interventions for preventing child maltreatment more generally.<sup>146–149</sup> Evidence is stronger for benefits at later follow-up: ‘ sleeper ’ effects may mean that benefits of interventions need time to emerge as parents become more practiced and confident in positive parenting strategies over time.<sup>150</sup> Expecting to detect effects of home visiting that starts in pregnancy on birth outcomes and on relatively insensitive child development measures may also be unreasonable in the context of the social disadvantage, discrimination and other challenges that adolescent mothers face before, during and after pregnancy.<sup>151</sup>

Despite reductions in adolescent pregnancies over recent decades, there remains a significant population of young and vulnerable mothers in England who need intensive support. Currently, the majority of these mothers are not receiving support from FNP, as it is not offered in all areas, and is only offered to around one in four mothers in areas in which it is commissioned. There is strong support for FNP locally, and FNP practitioners report that mothers participating in the programme develop more reflective parenting and awareness of their child’s needs. Without better evidence, removing support for young mothers could be harmful, especially in the context of increasing social disadvantage and widespread health visitor shortages that are already putting pressure on other services.<sup>152</sup> However, there remains uncertainty about which elements of intensive interventions are most effective, for whom and when and whether it is better to commission highly intensive services for a small portion of the target population or to extend and enhance universal services to better support all adolescent mothers.

**BOX 3** Findings from qualitative analysis on the themes of ‘Progress’, ‘Lack of understanding’, ‘Value’ and ‘Holistic approach’

#### Progress

For Annie, participating in the FNP programme when she was pregnant with her eldest child was life changing. Firstly, the FNP nurse helped Annie to develop her parenting practices which ‘*is completely different to how I was raised*’. Annie reported that her parents have commented on that. Secondly, Annie was able to explore healthy and unhealthy relationships in order to ‘*make that decision to say actually, you know, enough is enough*’. Annie reported that she is now in a loving, stable relationship. Thirdly, the FNP nurse supported Annie to advance her career. Annie is now a qualified midwife and health visitor; Annie is currently ‘*specialis[ing] in safeguarding*’. This has enabled Annie to reflect on ‘*how far we’ve come and how very, very, very different it could be*’.

#### Lack of understanding

Annie discussed the fact that long-term, qualitative outcomes that are important to parents are unlikely to be reflected in data: ‘*The stuff that I have achieved can’t be broken down by data*’.

#### Value

Annie commented that ‘she was probably the first and only person that truly believed in me and my ability’ and she ‘treated me like the adult that I was, really’. This included supporting Annie to make her own decision and advocate for herself. Annie reported that she did not want to attend Baby Groups and that ‘she [the FNP nurse] never forced it’.



**Holistic approach**

The FNP programme implements a holistic approach with parents and practitioners. For parents, the FNP nurses support them to identify 'what they would like to achieve ... and how they can get to where they want to get to' – Betsy.

The FNP nurses achieve this by using a strengths-based approach and providing the parents with boundaries: 'You want to find every opportunity to give affirmations because ... that really does build their confidence and help them to feel pride in achieving' – Betsy. 'I think having that ... therapeutic relationship, where it's bounded ... [and] consistent; something they might not have had in their, ... their life' – Carol.

The approaches were necessary for Annie: 'She really worked to your strength[s and] she was not judgmental at all'.

**Implications for policy and practice*****Delivering interventions to high-risk families***

To reduce social inequalities, effective interventions need to be available to all those who meet eligibility criteria. In 2010–7, most adolescent mothers at the highest risk of adverse outcomes were not receiving FNP, and we have few data on the support that they did receive during and after pregnancy. Eligible adolescent mothers living in areas with many births to adolescent mothers were least likely to receive FNP support. Moreover, adolescent mothers with similar vulnerabilities in areas where FNP was not commissioned were unlikely to have had access to equivalent intensive support. Our recommendations for delivering interventions to high-risk families are:

- Commissioning of interventions to adolescent mothers should aim to provide adequate support to meet the needs of all adolescent mothers (not just a subset of them) through increased provision of intensive services in line with local needs and the availability of other local services. For example, commissioning could be linked to the expected number of adolescents giving birth in an area; local priorities and other factors influencing local commissioning should be routinely recorded so that different commissioning strategies can be evaluated.
- Information about the maternal characteristics associated with outcomes should inform targeting in the context of insufficient commissioning of the programme.
- Other groups of mothers who have been shown to be at equally high risk for adverse child outcomes to adolescent mothers, such as those living in deprived areas and those with a history of unplanned hospital admissions for adversity or mental health conditions, should also be considered for intensive support (as they are in FNP ADAPT sites).<sup>60,89</sup>
- Decisions about the appropriate level of care for each family (including 'dialling up and dialling down' the intensity of support) should be based on continuous evaluations of who is most likely to benefit, supported by a more complete recording of vulnerabilities antenatally and real-time linkage of routine health and social care data.<sup>89,153</sup> This could add to primary prevention strategies aiming to improve reproductive choices for women about the timing of their pregnancies.

***Improving data to support quasi-experimental research studies***

There remains uncertainty about whether intensive home visiting is effective for reducing child maltreatment because of the potential for bias relating to the selection of the most vulnerable mothers into FNP on the basis of unmeasured characteristics (which could mask beneficial effects) and the lack of information about usual care for adolescent mothers not enrolled in FNP (which could introduce bias to the null). Understanding variations in usual care provision among both mothers enrolled in FNP and controls is also necessary to better estimate the incremental effect of FNP and account for any unexpected variation in usual care during the evaluation period. Such information would allow more nuanced interpretation of results, including, for example, if the programme worked better in one local area than another. Our recommendations for improving the available data to support evaluations of complex interventions using administrative data are:

- More complete recording of the characteristics that are used to prioritise mothers for enrolment in each site (including start and end dates of these prioritisation characteristics) and other important maternal characteristics for adjustment purposes.
- Detailed recording of programme metadata, including site activity dates and geography and criteria being used by FNP teams in order to correctly define eligible groups of mothers who were and were not enrolled or eligible for the intervention. These programme characteristics should be available in an easily searchable central repository.
- Individual-level or aggregate data on characteristics of all mothers-to-be offered enrolment and those who declined versus those who accepted enrolment.
- Improved, high-quality data on usual care, that is, community health contacts of all eligible women at the individual level (including, e.g. public health or teenage pregnancy midwife services, number and type of health visitor contacts, number of children's centres). These data could be captured in the Community Services Dataset, but the completeness of this data set is variable over time and across areas.<sup>137,139</sup>

## Recommendations for research

### *Development of the intervention*

- More research is needed to understand which elements of intensive interventions are most effective, for whom and when and to help inform decisions about whether it is better to commission highly intensive services for a small portion of the target population or to extend and enhance universal services to better support all adolescent mothers. For example, research could evaluate the effectiveness of enhanced midwifery support in pregnancy delivered by specialist teenage pregnancy midwives.
- Research is needed to understand the spillover effects of the programme on non-FNP mothers.<sup>154</sup> While the FNP may enhance other services (e.g. as trained family nurses take on other roles) by dissemination of trauma-informed approaches and understanding of the teenage brain, qualitative data also suggest that professionals are concerned about the licensed nature of FNP and not being able to share freely with wider health visiting colleagues or use it to change practice across services.<sup>111</sup> We do not yet know if FNP diverts resources away from the usual care that an adolescent mother should receive or if there are any other unintended harms of the programme.<sup>155</sup>
- There is ongoing work in the ADAPT sites to tailor the programme more closely to individual mothers and families. Further robust evaluation is needed of modifications to the FNP, including the changes included in the ADAPT sites and including outcomes for mothers aged 20–24 (who we could not assess in this study due to small numbers enrolled with sufficient follow-up).
- Better understanding is needed of how the programme and outcomes are affected by different modes of delivery, such as those that were implemented during the COVID-19 lockdown.<sup>156</sup> An evaluation of the FNP during lockdown in Scotland found that all survey respondents reported continuing home visits during lockdown, though some mothers were not comfortable receiving home visits. Mothers reported invaluable support and felt their family nurses provided stability, advice and care, particularly those who became socially isolated.

### *Improvement of delivery, including targeting*

- Research is needed to find ways to support achieving continuity of care and to support learning and wider sharing with health visiting colleagues, which would allow FNP to change practice across the service.
- Availability of more accurate individual- or household-level deprivation measures (including those available through Unique Property Reference Numbers) would improve our ability to create closely matched groups, provide enhanced information on the social support available within a household and help more effective targeting and follow-up of the many young mothers experiencing socioeconomic disadvantage.<sup>157</sup>

### *Measuring the right outcomes*

- We have reported initial findings from a qualitative study of the experiences of parents and practitioners involved in FNP, and further findings from this work will inform our understanding of the mechanisms of effect of FNP and for which outcomes we are most likely to see effects. This is particularly important in the context of quasi-experimental research studies, where bias and/or data limitations are likely to influence findings.
- Better measures of changes from enrolment in maternally reported well-being, confidence, mental health, parent-child interaction and child behaviour would allow us to understand more nuanced effects of the programme not routinely captured in administrative data.
- Future research should also consider outcomes for fathers, who have not been considered to date in evaluations of FNP and who are hard to capture in administrative data.<sup>158</sup>
- Research is needed to understand whether FNP can mediate outcomes for those with adverse birth conditions (e.g. preterm birth and low birthweight) and whether there are any residual (' sleeper') effects for subsequent children.
- More research is needed to understand whether the FNP has an effect on mortality for mothers and children, rates of abortions and the reasons for hospital admissions, including malnutrition.
- Future studies should quantify the total costs of FNP compared to usual care, including non-contact time of family nurses and additional resources used by FNP mothers and their children.

### *Design of future studies*

- A randomised controlled trial is needed to further evaluate the impact of the number of FNP visits or contacts on outcomes, including self-reported outcomes and other measures of child development, for example, Language Environment Analysis (LENA).<sup>159</sup> As a trial will also have its challenges, including attrition, recruitment and standardisation of usual care, experimental designs should also have a strong qualitative component to extend the contextual explanation of variation, for example, across localities.
- Other ways to analyse the data and avoid excluding high-risk mothers from analysis could be explored, for example, using target trial emulation.<sup>160</sup>
- Linkage to primary care and the Maternity Services Dataset could enable investigation of a wider range of risk factors.
- Routine linkage of education, social care and health data should be used to enable more efficient evaluations of early interventions.<sup>161</sup> Some organisations have called for the collection of a unique identifier in data for all children's services to enable services to work in a more joined-up way, which could be used to facilitate research in the future.<sup>162,163</sup>

# Additional information

## Acknowledgements

The authors would like to thank members of our Advisory Group from the Building Blocks trial team (Mike Robling, Rebecca Cannings-John and Fiona Lugg-Widger) for their advice on the design and interpretation of this study. MR, RCJ and FLW contributed to the discussion of potential biases relating to the study. We would also like to thank Linda Wijlaars for her help requesting and extracting the data and Emma Howarth for her input to the protocol.

We would like to thank members of our Study Steering Committee (Jane Barlow, Lorna Fraser, Emily Petherick, Marni Brownell, Loretta McGurry and Romy Labrosse) for their helpful input, advice and suggestions throughout the course of the study.

The authors would also like to thank the FNP National Unit for their help in establishing the linked dataset and interpreting the results, including Lynne Reed, Alisa Swarbrick, Andreea Calin, Sarah Tyndall and Alex Stevenson. We would also like to thank the FNP nurses and clinical leads who provided valuable insight into the results and the discussion, including Cheryl Beirne, Alison Goodall, Amanda Malthouse, Nicole Hobson and Christine Anderson. We would also like to thank Cheryl Adams and Alison Morton from the Institute of Health Visiting for their input.

We would like to thank Sue Hillsden from the FNP National Unit for her help identifying catchment areas and activity dates for FNP sites. We thank Nicole Hobson from the FNP National Unit, as well as Debbie Bougard, Karen Arkle, Caroline Scott, Mel Green, Lydia Ottavio, Catherine Dent, Charde Thompson, Anna Parry and Kristin Vreugdenhil from FNP teams, for their help with understanding referral processes and sharing aggregate enrolment data from their sites.

We would like to thank Jenny Woodman, Matt Jay, Anne McKay and Pip O'Byrne for their extremely valuable contributions to our interpretation of results and discussion within the report. We would also like to thank the UCL Great Ormond Street Institute of Child Health Statistics Group for their helpful advice on developing the propensity score matching approach.

## Contributions of authors

**Francesca Cavallaro** (<https://orcid.org/0000-0002-9641-8780>) did the analysis and contributed to writing the report.

**Amanda Clery** (<https://orcid.org/0000-0002-7366-9982>) did the analysis and contributed to writing the report.

**Ruth Gilbert** (<https://orcid.org/0000-0001-9347-2709>) contributed to the design of the study, interpretation of results and to writing the report.

**Jan van der Meulen** (<https://orcid.org/0000-0002-9451-2335>) contributed to the design of the study, interpretation of results and to writing the report.

Sally Kendall (<https://orcid.org/0000-0002-2507-0350>) contributed to the design of the study and interpretation of results.

Eilis Kennedy (<https://orcid.org/0000-0002-4162-4974>) contributed to the design of the study and interpretation of results.

Catherine Phillips (<https://orcid.org/0000-0002-9964-3684>) conducted the qualitative interviews.

Katie Harron (<https://orcid.org/0000-0002-3418-2856>) did the analysis, designed the study and wrote the report.

## Disclosure of interests

**Full disclosure of interests:** Completed ICMJE forms for all authors, including all related interests, are available in the toolkit on the NIHR Journals Library report publication page at <https://doi.org/10.3310/BVDW6447>.

**Primary conflicts of interest:** No competing interests.

## Patient data

This work uses data provided by patients and collected by the NHS as part of their care and support. Using patient data is vital to improve health and care for everyone. There is huge potential to make better use of information from people's patient records, to understand more about disease, develop new treatments, monitor safety and plan NHS services. Patient data should be kept safe and secure to protect everyone's privacy, and it is important that there are safeguards to make sure that they are stored and used responsibly. Everyone should be able to find out about how patient data are used. *#datasaveslives* You can find out more about the background to this citation here: <https://understandingpatientdata.org.uk/data-citation>.

## Data-sharing statement

All requests for the anonymised individual-level data from HES and NPD used in this report should be submitted for review to NHS Digital and DfE and may be granted subject to completion of a data-sharing agreement. All other enquiries should be sent to the corresponding author.

This work was produced using statistical data from ONS. The use of the ONS statistical data in this work does not imply the endorsement of the ONS in relation to the interpretation or analysis of the statistical data. This work uses research datasets that may not exactly reproduce National Statistics aggregates.

## Ethics and governance

Support for this study has been obtained from the Nottingham Research Ethics Committee (ref 18/EM/0014), the Department for Education (ref DR190430.02) and the Confidentiality Advisory Group (ref 18/CAG/0013). A Study Steering Committee oversaw the study and ensured it was conducted to rigorous standards. Support for the qualitative study was obtained from the University of Kent.

## Department of Health and Social Care disclaimer

This publication presents independent research commissioned by the National Institute for Health and Care Research (NIHR). The views and opinions expressed by the interviewees in this publication are those of the interviewees and do not necessarily reflect those of the authors, those of the NHS, the NIHR, MRC, NIHR Coordinating Centre, the HSDR programme or the Department of Health and Social Care.

This monograph was published based on current knowledge at the time and date of publication. NIHR is committed to being inclusive and will continually monitor best practice and guidance in relation to terminology and language to ensure that we remain relevant to our stakeholders.

## Publications

Cavallaro F, Gilbert R, Van der Meulen J, Kendall S, Kennedy E, Harron K. Intensive home visiting for adolescent mothers in the Family Nurse Partnership in England 2010–2019: a population-based data linkage cohort study using propensity score matching. *BMJ Public Health* 2024;**2**:e000514. <https://doi.org/10.23889/ijpds.v7i3.1831>



## References

1. Cavallaro FL, Gilbert R, Wijlaars L, Kennedy E, Swarbrick A, van der Meulen J, Harron K. Evaluating the real-world implementation of the Family Nurse Partnership in England: protocol for a data linkage study. *BMJ Open* 2020;**10**:e038530.
2. Cavallaro FL, Gilbert R, Wijlaars LP, Kennedy E, Howarth E, Kendall S, *et al*. Characteristics of enrolment in an intensive home-visiting programme among eligible first-time adolescent mothers in England: a linked administrative data cohort study. *J Epidemiol Commun Health* 2022;**76**:991–8.
3. Office for National Statistics (ONS). *Birth Characteristics 2019*. ONS; 2022. URL: [www.ons.gov.uk/peoplepopulationandcommunity/birthsdeathsandmarriages/livebirths/datasets/birthcharacteristicsinenglandandwales](http://www.ons.gov.uk/peoplepopulationandcommunity/birthsdeathsandmarriages/livebirths/datasets/birthcharacteristicsinenglandandwales) (accessed 5 October 2022).
4. Crawford C, Cribb J, Kelly E. *Teenage Pregnancy in England*. Contract No.: December 2019. 2013. URL: <https://ifs.org.uk/publications/teenage-pregnancy-england> (accessed 5 January 2023).
5. Wellings K, Palmer MJ, Geary RS, Gibson LJ, Copas A, Datta J, *et al*. Changes in conceptions in women younger than 18 years and the circumstances of young mothers in England in 2000–12: an observational study. *Lancet* 2016;**388**:586–95.
6. Bellis MA, Hughes K, Leckenby N, Perkins C, Lowey H. National household survey of adverse childhood experiences and their relationship with resilience to health-harming behaviors in England. *BMC Med* 2014;**12**:72.
7. Rigsby DC, Macones GA, Driscoll DA. Risk factors for rapid repeat pregnancy among adolescent mothers: a review of the literature. *J Ped Adoles Gynecol* 1998;**11**:115–26.
8. Restrepo-Méndez MC, Lawlor DA, Horta BL, Matijasevich A, Santos IS, Menezes AMB, *et al*. The association of maternal age with birthweight and gestational age: a cross-cohort comparison. *Paediatr Perinat Epidemiol* 2015;**29**:31–40.
9. Cunnington AJ. What's so bad about teenage pregnancy? *J Fam Plann Reprod Health Care* 2001;**27**:36–41.
10. Stier DM, Leventhal JM, Berg AT, Johnson L, Mezger J. Are children born to young mothers at increased risk of maltreatment? *Pediatrics* 1993;**91**:642–8.
11. Gonzalez A, MacMillan HL. Preventing child maltreatment: an evidence-based update. *J Postgrad Med* 2008;**54**:280–6.
12. Jutte DP, Roos NP, Brownell MD, Briggs G, MacWilliam L, Roos LL. The ripples of adolescent motherhood: social, educational, and medical outcomes for children of teen and prior teen mothers. *Acad Pediatr* 2010;**10**:293–301.
13. Wiggins M, Oakley A, Sawtell M, Austerberry H, Clemens F, Elbourne D. *Teenage Parenthood and Social Exclusion: A Multi-Method Study – Summary Report of Findings*. Contract No.: November 2019. London: Social Science Research Unit, Institute of Education; 2005. URL: <https://discovery.ucl.ac.uk/id/eprint/10003007/1/Wiggins2005TeenageParenthood.pdf> (accessed 5 October 2022).
14. Lawlor D, Shaw M, Johns S. Teenage pregnancy is not a public health problem. *BMJ* 2001;**323**:1428.
15. Buck D, Gregory S. *Improving the Public's Health: A Resource for Local Authorities*. London: The King's Fund; 2013.



16. Booth CM, Tannock IF. Randomised controlled trials and population-based observational research: partners in the evolution of medical evidence. *Br J Cancer* 2014;**110**:551–5.
17. Cowley S, Whittaker K, Malone M, Donetto S, Grigulis A, Maben J. What makes health visiting successful – or not? 1. Universality. *J Health Visit* 2018;**6**:352–60.
18. Public Health England. *Best Start in Life and Beyond: Improving Public Health Outcomes for Children, Young People and Families. Guidance to Support the Commissioning of the Healthy Child Programme 0 to 19: Health Visiting and School Nursing Services*. Contract No.: January 2021. London: Public Health England; 2018. URL: [https://assets.publishing.service.gov.uk/government/uploads/system/uploads/attachment\\_data/file/716028/best\\_start\\_in\\_life\\_and\\_beyond\\_commissioning\\_guidance\\_2.pdf](https://assets.publishing.service.gov.uk/government/uploads/system/uploads/attachment_data/file/716028/best_start_in_life_and_beyond_commissioning_guidance_2.pdf) (accessed 5 October 2022).
19. Marmot M. *Fair Society, Healthy Lives: The Marmot Review*. Contract No.: January 2021. London: Strategic Review of Health Inequalities in England post-2010; 2010. URL: [www.instituteofhealthequity.org/resources-reports/fair-society-healthy-lives-the-marmot-review/fair-society-healthy-lives-full-report-pdf.pdf](http://www.instituteofhealthequity.org/resources-reports/fair-society-healthy-lives-the-marmot-review/fair-society-healthy-lives-full-report-pdf.pdf) (accessed 5 October 2022).
20. Robling M, Bekkers M-J, Bell K, Butler CC, Cannings-John R, Channon S, *et al*. Effectiveness of a nurse-led intensive home-visitation programme for first-time teenage mothers (building blocks): a pragmatic randomised controlled trial. *Lancet* 2016;**387**:146–55.
21. Olds DL, Hill PL, O'Brien R, Racine D, Moritz P. Taking preventive intervention to scale: the nurse–family partnership. *Cogn Behav Pract* 2003;**10**:278–90.
22. Olds D. Building evidence to improve maternal and child health. *Lancet* 2016;**387**:105–7.
23. Barlow J, Barnes J, Sylva K, Fonagy P, Fearon P. Questioning the outcome of the Building Blocks trial. *Lancet* 2016;**387**:1615–6.
24. Robling M, Lugg-Widger F, Cannings-John R, Sanders J, Angel L, Channon S, *et al*. The Family Nurse Partnership to reduce maltreatment and improve child health and development in young children: the BB:2–6 routine data-linkage follow-up to earlier RCT. *Public Health Res* 2021;**9**:1160.
25. Olds DL, Henderson CR Jr, Chamberlin R, Tatelbaum R. Preventing child abuse and neglect: a randomized trial of nurse home visitation. *Pediatrics* 1986;**78**:65–78.
26. Olds DL, Henderson CR Jr, Kitzman H. Does prenatal and infancy nurse home visitation have enduring effects on qualities of parental caregiving and child health at 25 to 50 months of life? *Pediatrics* 1994;**93**:89–98.
27. Kitzman H, Olds DL, Henderson CR Jr, Hanks C, Cole R, Tatelbaum R, *et al*. Effect of prenatal and infancy home visitation by nurses on pregnancy outcomes, childhood injuries, and repeated childbearing. A randomized controlled trial. *JAMA* 1997;**278**:644–52.
28. Eckenrode J, Ganzel B, Henderson CR Jr, Smith E, Olds DL, Powers J, *et al*. Preventing child abuse and neglect with a program of nurse home visitation: the limiting effects of domestic violence. *JAMA* 2000;**284**:1385–91.
29. Olds D, Henderson CR Jr, Kitzman H, Cole R. Effects of prenatal and infancy nurse home visitation on surveillance of child maltreatment. *Pediatrics* 1995;**95**:365–72.
30. Olds DL, Henderson CR Jr, Tatelbaum R. Prevention of intellectual impairment in children of women who smoke cigarettes during pregnancy. *Pediatrics* 1994;**93**:228–33.
31. Olds DL, Kitzman H, Cole R, Robinson JA, Sidora K, Luckey DW, *et al*. Effects of nurse home-visiting on maternal life course and child development: age 6 follow-up results of a randomized trial. *Pediatrics* 2004;**114**:1550–9.

32. Olds DL, Kitzman H, Hanks C, Cole R, Anson E, Sidora-Arcoleo K, *et al.* Effects of nurse home visiting on maternal and child functioning: age-9 follow-up of a randomized trial. *Pediatrics* 2007;**120**:e832–45.
33. Kitzman H, Olds DL, Knudtson MD, Cole R, Anson B, Smith JA, *et al.* Prenatal and/or infancy nurse home visiting and 18-year outcomes of a randomized trial. *Pediatrics* 2019;**144**:e20183876.
34. Olds DL, Robinson J, Pettitt L, Luckey DW, Holmberg J, Ng RK, *et al.* Effects of home visits by paraprofessionals and by nurses: age 4 follow-up results of a randomized trial. *Pediatrics* 2004;**114**:1560–8.
35. Olds DL, Robinson J, O'Brien R, Luckey DW, Pettitt LM, Henderson CR, *et al.* Home visiting by paraprofessionals and by nurses: a randomized, controlled trial. *Pediatrics* 2002;**110**:486–96.
36. Olds DL, Holmberg JR, Donelan-McCall N, Luckey DW, Knudtson MD, Robinson J. Effects of home visits by paraprofessionals and by nurses on children: follow-up of a randomized trial at ages 6 and 9 years. *JAMA Ped* 2014;**168**:114–21.
37. Olds DL, Kitzman H, Knudtson MD, Anson E, Smith JA, Cole R. Effect of home visiting by nurses on maternal and child mortality: results of a 2-decade follow-up of a randomized clinical trial. *JAMA Ped* 2014;**168**:800–6.
38. Olds DL, Eckenrode J, Henderson CR Jr, Kitzman H, Powers J, Cole R, *et al.* Long-term effects of home visitation on maternal life course and child abuse and neglect. Fifteen-year follow-up of a randomized trial. *JAMA* 1997;**278**:637–43.
39. Olds DL, Kitzman H, Anson E, Smith JA, Knudtson MD, Miller T, *et al.* Prenatal and infancy nurse home visiting effects on mothers: 18-year follow-up of a randomized trial. *Pediatrics* 2019;**144**:e20183889.
40. Olds DL, Henderson CR Jr, Tatelbaum R, Chamberlin R. Improving the life-course development of socially disadvantaged mothers: a randomized trial of nurse home visitation. *Am J Public Health* 1988;**78**:1436–45.
41. Kitzman H, Olds DL, Sidora K, Henderson CR, Hanks C, Cole R, *et al.* Enduring effects of nurse home visitation on maternal life course: a 3-year follow-up of a randomized trial. *JAMA* 2000;**283**:1983–9.
42. Olds DL, Kitzman HJ, Cole RE, Hanks CA, Arcoleo KJ, Anson EA, *et al.* Enduring effects of prenatal and infancy home visiting by nurses on maternal life course and government spending: follow-up of a randomized trial among children at age 12 years. *Arch Pediatr Adolesc Med* 2010;**164**:419–24.
43. McConnell MA, Rokicki S, Ayers S, Allouch F, Perreault N, Gourevitch RA, *et al.* Effect of an intensive nurse home visiting program on adverse birth outcomes in a medicaid-eligible population: a randomized clinical trial. *JAMA* 2022;**328**:27–37.
44. Robling M, Bekkers MJ, Bell K, Butler CC, Cannings-John R, Channon S, *et al.* Effectiveness of a nurse-led intensive home-visitation programme for first-time teenage mothers (Building Blocks): a pragmatic randomised controlled trial. *Lancet* 2016;**387**:146–55.
45. Mejdoubi J, van den Heijkant SC, van Leerdam FJ, Heymans MW, Crijnen A, Hirasing RA. The effect of VoorZorg, the Dutch nurse–family partnership, on child maltreatment and development: a randomized controlled trial. *PLOS ONE* 2015;**10**:e0120182.

46. Mejdoubi J, van den Heijkant SCCM, van Leerdam FJM, Heymans MW, Hirasing RA, Crijnen AAM. Effect of nurse home visits vs. usual care on reducing intimate partner violence in young high-risk pregnant women: a randomized controlled trial. *PLOS ONE* 2013;**8**:e78185.
47. Sierau S, Dahne V, Brand T, Kurtz V, von Klitzing K, Jungmann T. Effects of home visitation on maternal competencies, family environment, and child development: a randomized controlled trial. *Prev Sci* 2016;**17**:40–51.
48. Kliem S, Sandner M. Prenatal and infancy home visiting in Germany: 7-year outcomes of a randomized trial. *Pediatrics* 2021;**148**:e2020049610.
49. Conti G, Poupakis S, Sandner M, Kliem S. The effects of home visiting on mother–child interactions: evidence from a randomized trial using dynamic micro-level data. *Child Abuse Negl* 2021;**115**:105021.
50. Catherine NL, Gonzalez A, Boyle M, Sheehan D, Jack SM, Hougham KA, *et al.*, British Columbia Healthy Connections Project Scientific Team. Improving children’s health and development in British Columbia through nurse home visiting: a randomized controlled trial protocol. *BMC Health Serv Res* 2016;**16**:349.
51. Segal L, Nguyen H, Gent D, Hampton C, Boffa J. Child protection outcomes of the Australian Nurse Family Partnership Program for Aboriginal infants and their mothers in Central Australia. *PLOS ONE* 2018;**13**:e0208764.
52. Carabin H, Cowan LD, Beebe LA, Skaggs VJ, Thompson D, Agbangla C. Does participation in a nurse visitation programme reduce the frequency of adverse perinatal outcomes in first-time mothers? *Paediatr Perinat Epidemiol* 2005;**19**:194–205.
53. Rubin DM, O’Reilly AL, Luan X, Dai D, Localio AR, Christian CW. Variation in pregnancy outcomes following statewide implementation of a prenatal home visitation program. *Arch Pediatr Adolesc Med* 2011;**165**:198–204.
54. Matone M, O’Reilly AL, Luan X, Localio AR, Rubin DM. Emergency department visits and hospitalizations for injuries among infants and children following statewide implementation of a home visitation model. *Matern Child Health J* 2012;**16**:1754–61.
55. Flowers M, Sainer S, Stoneburner A, Thorland W. Education and employment outcomes in clients of the Nurse–Family Partnership. *Public Health Nurs* 2020;**37**:206–14.
56. Thorland W, Currie DW. Status of birth outcomes in clients of the Nurse–Family Partnership. *Matern Child Health J* 2017;**21**:995–1001.
57. Lugg-Widger FV, Robling M, Lau M, Paranjothy S, Pell J, Sanders J, *et al.* Evaluation of the effectiveness of the Family Nurse Partnership home visiting programme in first time young mothers in Scotland: a protocol for a natural experiment. *Int J Pop Data Sci* 2020;**5**:1154.
58. Barnes J, Stuart J, Allen E, Petrou S, Sturgess J, Barlow J, *et al.* Results of the First Steps study: a randomised controlled trial and economic evaluation of the Group Family Nurse Partnership (gFNP) programme compared with usual care in improving outcomes for high-risk mothers and their children and preventing abuse. *Public Health Res* 2017. URL: <http://ncbi.nlm.nih.gov/books/NBK464661/> (accessed 5 October 2022).
59. Mejdoubi J, van den Heijkant S, Struijf E, van Leerdam F, HiraSing R, Crijnen A. Addressing risk factors for child abuse among high risk pregnant women: design of a randomised controlled trial of the nurse family partnership in Dutch preventive health care. *BMC Public Health* 2011;**11**:823.
60. Family Nurse Partnership National Unit & Dartington Service Design Lab. *FNP ADAPT: Using Evidence, Pragmatism and Collaboration to Change the FNP Programme in London*. Contract No.:

- December 2020. London; 2020. URL: [www.fnp.nhs.uk/media/1359/fnp\\_adapt\\_report\\_web.pdf](http://www.fnp.nhs.uk/media/1359/fnp_adapt_report_web.pdf) (accessed 5 October 2022).
61. Lawlor D, Shaw M, Johns S. Teenage pregnancy is not a public health problem. *BMJ* 2001;**323**:1428–9.
  62. Crawford C, Cribb J, Kelly E. *Teenage Pregnancy in England 2013*. URL: <https://ifs.org.uk/publications/teenage-pregnancy-england> (accessed 4 January 2024).
  63. Mejdoubi J, van den Heijkant SC, van Leerdam FJ, Crone M, Crijnen A, HiraSing RA. Effects of nurse home visitation on cigarette smoking, pregnancy outcomes and breastfeeding: a randomized controlled trial. *Midwifery* 2014;**30**:688–95.
  64. Cannings-John R, Lugg-Widger F, Lau M, Paranjothy S, Pell J, Sanders J, et al. *Evaluation of Family Nurse Partnership: Methods and Process of Evaluation – Appendix 1: Logic Model*. Contract No.: March 2020. 2020. URL: [www.gov.scot/publications/evaluation-family-nurse-partnership-scotland-methods-paper-process-success-linkages/pages/13/](http://www.gov.scot/publications/evaluation-family-nurse-partnership-scotland-methods-paper-process-success-linkages/pages/13/) (accessed 5 October 2022).
  65. Bryar RM, Cowley DSA, Adams CM, Kendall S, Mathers N. Health visiting in primary care in England: a crisis waiting to happen? *Br J Gener Pract: J Royal Coll Gener Pract* 2017;**67**:102–3.
  66. Kennedy-Martin T, Curtis S, Faries D, Robinson S, Johnston J. A literature review on the representativeness of randomized controlled trial samples and implications for the external validity of trial results. *Trials* 2015;**16**:495.
  67. Ogilvie D, Cummins S, Petticrew M, White M, Jones A, Wheeler K. Assessing the evaluability of complex public health interventions: five questions for researchers, funders, and policymakers. *Milbank Q* 2011;**89**:206–25.
  68. Booth CM, Tannock IF. Randomised controlled trials and population-based observational research: partners in the evolution of medical evidence. *Br J Cancer* 2014;**110**:551–5.
  69. Harron K, Gilbert R, Cromwell D, van der Meulen J. Linking data for mothers and babies in de-identified electronic health data. *PLOS ONE* 2016;**11**:e0164667.
  70. Harron KL, Doidge JC, Knight HE, Gilbert RE, Goldstein H, Cromwell DA, van der Meulen JH. A guide to evaluating linkage quality for the analysis of linked data. *Int J Epidemiol* 2017;**46**:1699–710.
  71. Libuy N, Harron K, Gilbert R, Caulton R, Cameron E, Blackburn R. Linking education and hospital data in England: linkage process and quality. *Int J Pop Data Sci* 2021;**6**:1671.
  72. Herbert A, Wijlaars L, Zylbersztejn A, Cromwell D, Hardeid P. Data resource profile: hospital episode statistics admitted patient care (HES APC). *Int J Epidemiol* 2017;**46**:1093–1093.i.
  73. International Classification of Diseases (ICD). *International Classification of Diseases, 10th Revision, Clinical Modification (ICD-10-CM)*. 2011. URL: <https://cdc.gov/nchs/icd/icd-10-cm.htm> (accessed 5 October 2022).
  74. Health and Social Care Information Centre. *OPCS-4 Classification of Interventions and Procedures*. 2019. URL: <https://digital.nhs.uk/data-and-information/information-standards/information-standards-and-data-collections-including-extractions/publications-and-notifications/standards-and-collections/dcb0084-opcs-classification-of-interventions-and-procedures#:~:text=this%20information%20standard,OPCS%2D4%20is%20a%20statistical%20classification%20for%20clinical%20coding%20of,data%20collections%20for%20secondary%20uses> (accessed 10 May 2022).
  75. McGrath-Lone L, Harron K, Dearden L, Nasim B, Gilbert R. Data resource profile: children looked after return (CLA). *Int J Epidemiol* 2016;**45**:716–17.

76. Department for Education, National Statistics. *Characteristics of Children in Need: 2018–2019*. Contract No.: December 2019. 2019. URL: [www.gov.uk/government/statistics/characteristics-of-children-in-need-2018-to-2019](http://www.gov.uk/government/statistics/characteristics-of-children-in-need-2018-to-2019) (accessed 5 October 2022).
77. Department for Education. *Children Looked After by Local Authorities in England: Guide to the SSDA903 Collection 1 April 2019 to 31 March 2020 – Version 1.2*. Contract No.: December 2019. 2019. URL: [https://assets.publishing.service.gov.uk/government/uploads/system/uploads/attachment\\_data/file/839236/CLA\\_SSDA903\\_2019-20\\_Guide\\_Version\\_1.2.pdf](https://assets.publishing.service.gov.uk/government/uploads/system/uploads/attachment_data/file/839236/CLA_SSDA903_2019-20_Guide_Version_1.2.pdf) (accessed 5 October 2022).
78. McGrath-Lone L, Dearden L, Nasim B, Harron K, Gilbert R. Changes in first entry to out-of-home care from 1992 to 2012 among children in England. *Child Abuse Negl* 2016;**51**:163–71.
79. Grath-Lone LM, Woodman J, Gilbert R. Safeguarding children and improving their care in the UK. *Lancet* 2015;**386**:1630.
80. Corbacho B, Bell K, Stamuli E, Richardson G, Ronaldson S, Hood K, et al., Building Blocks trial group. Cost-effectiveness of the Family Nurse Partnership (FNP) programme in England: Evidence from the building blocks trial. *J Eval Clin Pract* 2017;**23**:1367–74.
81. Schnitzer PG, Slusher PL, Kruse RL, Tarleton MM. Identification of ICD codes suggestive of child maltreatment. *Child Abuse Negl* 2011;**35**:3–17.
82. Gilbert R, Fluke J, O'Donnell M, Gonzalez-Izquierdo A, Brownell M, Gulliver P, et al. Child maltreatment: variation in trends and policies in six developed countries. *Lancet* 2012;**379**:758–72.
83. Emmott EH, Jay MA, Woodman J. Cohort profile: Children in Need Census (CIN) records of children referred for social care support in England. *BMJ Open* 2019;**9**:e023771.
84. World Health Organization (WHO). *Report of a WHO Technical Consultation on Birth Spacing. Geneva, Switzerland 13–15 June 2005*. Contract No.: December 2019. WHO; 2007. URL: [https://apps.who.int/iris/bitstream/handle/10665/69855/WHO\\_RHR\\_07.1\\_eng.pdf?sequence=1](https://apps.who.int/iris/bitstream/handle/10665/69855/WHO_RHR_07.1_eng.pdf?sequence=1) (accessed 5 October 2022).
85. Conde-Agudelo A, Rosas-Bermúdez A, Kafury-Goeta AC. Birth spacing and risk of adverse perinatal outcomes: a meta-analysis. *JAMA* 2006;**295**:1809–23.
86. Department for Education, National Statistics. *Early Years Foundation Stage Profile Results in England, 2018*. Contract No.: December 2019. 2018. URL: [https://assets.publishing.service.gov.uk/government/uploads/system/uploads/attachment\\_data/file/748814/EYFSP\\_2018\\_Main\\_Text.pdf](https://assets.publishing.service.gov.uk/government/uploads/system/uploads/attachment_data/file/748814/EYFSP_2018_Main_Text.pdf) (accessed 5 October 2022).
87. Herbert A, Gilbert R, González-Izquierdo A, Li L. Violence, self-harm and drug or alcohol misuse in adolescents admitted to hospitals in England for injury: a retrospective cohort study. *BMJ Open* 2015;**5**:e006079.
88. NHS Digital. *Maternity Services Monthly Statistics November 2019, Experimental Statistics – Gestational Age at Booking Appointment*. Contract No.: February 2021. 2020. URL: <https://digital.nhs.uk/data-and-information/publications/statistical/maternity-services-monthly-statistics/november-2019/analysis> (accessed 5 October 2022).
89. Harron K, Gilbert R, Fagg J, Guttman A, van der Meulen J. Associations between pre-pregnancy psychosocial risk factors and infant outcomes: a population-based cohort study in England. *Lancet Pub Health* 2021;**6**:e97–105.
90. Hardelid P, Dattani N, Gilbert R, Programme Board of the Royal College of Paediatrics and Child Health. Estimating the prevalence of chronic conditions in children who die in England, Scotland and Wales: a data linkage cohort study. *BMJ Open*. 2014;**4**:e005331.

91. Pearson RJ, Jay MA, Wijlaars LPMM, De Stavola B, Syed S, Bedston SJ, Gilbert R. Association between health indicators of maternal adversity and the rate of infant entry to local authority care in England: a longitudinal ecological study. *BMJ Open* 2020;**10**:e036564.
92. Austin PC. An introduction to propensity score methods for reducing the effects of confounding in observational studies. *Multiv Behav Res* 2011;**46**:399–424.
93. Li F, Zaslavsky AM, Landrum MB. Propensity score weighting with multilevel data. *Stat Med* 2013;**32**:3373–87.
94. Blake HA, Leyrat C, Mansfield KE, Seaman S, Tomlinson LA, Carpenter J, Williamson EJ. Propensity scores using missingness pattern information: a practical guide. *Stat Med* 2020;**39**:1641–57.
95. Austin PC. Balance diagnostics for comparing the distribution of baseline covariates between treatment groups in propensity-score matched samples. *Stat Med* 2009;**28**:3083–107.
96. Stata. *Stata Statistical Software: Release 17*. College Station, TX: StataCorp LP; 2021.
97. Arpino B, Cannas M. Propensity score matching with clustered data. An application to the estimation of the impact of caesarean section on the Apgar score. *Stat Med* 2016;**35**:2074–91.
98. Martin C, Marryat L, Miller M, Ormston R, Gordon J. *The Evaluation of the Family Nurse Partnership Programme in Scotland: Phase 1 Report – Intake and Early Pregnancy* Scottish Government Social Research. 2011. URL: [www.gov.scot/publications/evaluation-family-nurse-partnership-programme-scotland-phase-1-report-intake-early-pregnancy/documents/](http://www.gov.scot/publications/evaluation-family-nurse-partnership-programme-scotland-phase-1-report-intake-early-pregnancy/documents/) (accessed 3 August 2022).
99. Robling M. *The Building Blocks Trial. Evaluating the Family Nurse Partnership Programme in England: A Randomised Controlled Trial*. 2015. URL: [www.cardiff.ac.uk/\\_\\_data/assets/pdf\\_file/0009/504729/Building-Blocks-Full-Study-Report.pdf](http://www.cardiff.ac.uk/__data/assets/pdf_file/0009/504729/Building-Blocks-Full-Study-Report.pdf) (accessed 15 January 2019).
100. Braun V, Clarke V. Using thematic analysis in psychology. *Qual Res Psychol* 2006;**3**:77–101.
101. Cavallaro FL, Cannings-John R, Lugg-Widger F, Gilbert R, Kennedy E, Kendall S, et al. Lessons learned from using linked administrative data to evaluate the Family Nurse Partnership in England and Scotland. *Int J Population Data Sci* 2023;**8**:2113.
102. Harron K, McGrath-Lone L, Mason S, Gilbert R. *Using Linked Administrative Data for Monitoring and Evaluating the Family Nurse Partnership in England: A Scoping Report*. Contract No.: December 2020. 2016. URL: <http://repository.tavistockandportman.ac.uk/1448/> (accessed 5 October 2022).
103. Sword WA, Krueger PD, Watt MS. Predictors of acceptance of a postpartum public health nurse home visit: findings from an Ontario survey. *Can J Public Health* 2006;**97**:191–6.
104. Alonso-Marsden S, Dodge KA, O'Donnell KJ, Murphy RA, Sato JM, Christopoulos C. Family risk as a predictor of initial engagement and follow-through in a universal nurse home visiting program to prevent child maltreatment. *Child Abuse Negl* 2013;**37**:555–65.
105. Chartier MJ, Brownell MD, Isaac MR, Chateau D, Nickel NC, Katz A, et al. Is the families first home visiting program effective in reducing child maltreatment and improving child development? *Child Maltreat* 2017;**22**:121–31.
106. Bell K, Corbacho B, Ronaldson S, Richardson G, Hood K, Sanders J, et al., Building Blocks Trial Group. Costs and consequences of the Family Nurse Partnership (FNP) programme in England: evidence from the Building Blocks trial. *F1000Res* 2019;**8**:1640.
107. 0-5 Transfer Team. *Transfer of 0-5 Children's Public Health Commissioning to Local Authorities: Equality Analysis*. Contract No.: July 2021. London: Department of Health; 2015. URL: <https://>

- [assets.publishing.service.gov.uk/government/uploads/system/uploads/attachment\\_data/file/417429/Equality\\_analysis.pdf](https://assets.publishing.service.gov.uk/government/uploads/system/uploads/attachment_data/file/417429/Equality_analysis.pdf) (accessed 5 October 2022).
108. Feder GS, Hutson M, Ramsay J, Taket AR. Women exposed to intimate partner violence: expectations and experiences when they encounter health care professionals: a meta-analysis of qualitative studies. *Arch J Med* 2006;**166**:22–37.
  109. McTavish JR, Kimber M, Devries K, Colombini M, MacGregor JCD, Wathen N, MacMillan HL. Children's and caregivers' perspectives about mandatory reporting of child maltreatment: a meta-synthesis of qualitative studies. *BMJ Open* 2019;**9**:e025741.
  110. Lewis NV, Feder GS, Howarth E, Szilassy E, McTavish JR, MacMillan HL, Wathen N. Identification and initial response to children's exposure to intimate partner violence: a qualitative synthesis of the perspectives of children, mothers and professionals. *BMJ Open* 2018;**8**:e019761.
  111. Sanders J, Channon S, Gobat N, Bennert K, Addison K, Robling M. Implementation of the Family Nurse Partnership programme in England: experiences of key health professionals explored through trial parallel process evaluation. *BMC Nurs* 2019;**18**:13.
  112. Downs J, Setakis E, Mostafa T, Hayes R, Hotopf M, Ford T, Gilbert R. Linking strategies and biases when matching cohorts to the National Pupil Database. IJPDS (2017) Issue 1, Vol 1:348 Proceedings of the IPDLN Conference (August 2016). *Int J Pop Data Sci* 2017;**1**:369.
  113. Grath-Lone LM, Libuy N, Etoori D, Blackburn R, Gilbert R, Harron K. Ethnic bias in data linkage. *Lancet Digit Health* 2021;**3**:e339.
  114. Bilson A, Martin KEC. Referrals and child protection in England: one in five children referred to children's services and one in nineteen investigated before the age of five. *Br J Soc Work* 2016;**47**:793–811.
  115. Jay MA, De Stavola B, Dorsett R, Thomson D, Gilbert R. Model estimates of cumulative incidence of children in need status and referral to children's social care. OSF. 2022. URL: <https://osf.io/6ecrz/> (accessed 5 October 2022).
  116. Olds D. Improving the report of the Building Blocks 2–6 study. *BMJ Open* 2022;**12**. URL: <https://bmjopen.bmj.com/content/12/2/e049960.responses#improving-the-report-of-the-building-blocks-2-6-study-> (accessed 5 October 2022).
  117. Saigal S, Doyle LW. An overview of mortality and sequelae of preterm birth from infancy to adulthood. *Lancet* 2008;**371**:261–9.
  118. Libuy N, Gilbert R, Mc Grath-Lone L, Blackburn R, Etoori D, Harron K. Gestational age at birth, chronic conditions and school outcomes: a population-based data linkage study of children born in England. *Int J Epidemiol* 2022;**52**:132–143.
  119. Barker M, Dombrowski SU, Colbourn T, Fall CHD, Kriznik NM, Lawrence WT, *et al*. Intervention strategies to improve nutrition and health behaviours before conception. *Lancet* 2018;**391**:1853–64.
  120. Goyal NK, Teeters A, Ammerman RT. Home visiting and outcomes of preterm infants: a systematic review. *Pediatrics* 2013;**132**:502–16.
  121. Liu N, Li P, Wang J, Chen D, Sun W, Zhang W. Effects of home visits for pregnant and postpartum women on premature birth, low birth weight and rapid repeat birth: a meta-analysis and systematic review of randomized controlled trials. *Fam Pract* 2019;**36**:533–43.
  122. Harron K, Gilbert R, Cromwell D, Oddie S, Guttman A, van der Meulen J. International comparison of emergency hospital use for infants: data linkage cohort study in Ontario and England. *BMJ Qual Saf* 2018;**27**:31–9.

123. Teager W, McBride M. *An Initial Assessment of the 2-year-old Free Childcare Entitlement: Drivers of Take-up and Impact on Early Years Outcomes*. Early Intervention Foundation; 2018. URL: [www.eif.org.uk/report/an-initial-assessment-of-the-2-year-old-free-childcare-entitlement](http://www.eif.org.uk/report/an-initial-assessment-of-the-2-year-old-free-childcare-entitlement) (accessed 24 August 2022).
124. Sahota P, Woodward J, Molinari R, Pike J. Factors influencing take-up of free school meals in primary- and secondary-school children in England. *Public Health Nutr* 2014;**17**:1271–9.
125. Taylor C. The reliability of free school meal eligibility as a measure of socio-economic disadvantage: evidence from the millennium cohort study in Wales. *Br J Educ Stud* 2018;**66**:29–51.
126. Gov.uk. *Schools, Pupils and Their Characteristics*. 2022. URL: <https://explore-education-statistics.service.gov.uk/find-statistics/school-pupils-and-their-characteristics> (accessed 17 August 2022).
127. Guttmann A, Blackburn R, Amartey A, Zhou L, Wijlaars L, Saunders N, *et al*. Long-term mortality in mothers of infants with neonatal abstinence syndrome: a population-based parallel-cohort study in England and Ontario, Canada. *PLOS Med* 2019;**16**:e1002974.
128. Wellings K, Jones KG, Mercer CH, Tanton C, Clifton S, Datta J, *et al*. The prevalence of unplanned pregnancy and associated factors in Britain: findings from the third National Survey of Sexual Attitudes and Lifestyles (Natsal-3). *Lancet* 2013;**382**:1807–16.
129. Dartington Service Design Lab, Family Nurse Partnership National Unit. *FNP ADAPT: Using Evidence, Pragmatism and Collaboration to Change the FNP Programme in England* 2020. URL: [www.fnp.nhs.uk/media/1359/fnp\\_adapt\\_report\\_web.pdf](http://www.fnp.nhs.uk/media/1359/fnp_adapt_report_web.pdf) (accessed 18 August 2022).
130. Owens R. *Digging Down and Scaling Up: A Psychosocial Exploration of the Family Nurse Partnership*. Sussex: University of Sussex; 2020.
131. Bakermans-Kranenburg MJ, van IMH, Juffer F. Less is more: meta-analyses of sensitivity and attachment interventions in early childhood. *Psychol Bull* 2003;**129**:195–215.
132. Kliem S, Sandner M, Lohmann A, Sierau S, Dähne V, Klein AM, Jungmann T. Follow-up study regarding the medium-term effectiveness of the home-visiting program “Pro Kind” at age 7 years: study protocol for a randomized controlled trial. *Trials* 2018;**19**:323.
133. Cheong-See F, Allotey J, Marlin N, Mol BW, Schuit E, Riet GT, *et al*. Prediction models in obstetrics: understanding the treatment paradox and potential solutions to the threat it poses. *Int J Obstet Gynaecol* 2016;**123**:1060–4.
134. Feder GS, Hutson M, Ramsay J, Taket AR. Women exposed to intimate partner violence: expectations and experiences when they encounter health care professionals: a meta-analysis of qualitative studies. *Arch Intern Med* 2006;**166**:22–37.
135. Bennett V. *Continuing the Mandation of the Universal Five Health Visiting Checks*. Contract No.: March 2020. Public Health England; 2017. URL: <https://publichealthmatters.blog.gov.uk/2017/03/01/continuing-the-mandation-of-the-universal-five-health-visiting-checks/> (accessed 5 October 2022).
136. Robling M, Cannings-John R, Channon S, Hood K, Moody G, Poole R, Sanders J. What is usual care for teenagers expecting their first child in England? A process evaluation using key informant mapping and participant survey as part of the Building Blocks randomised controlled trial of specialist home visiting. *BMJ Open* 2018;**8**:e020152.
137. Fraser C, Harron K, Barlow J, Bennett S, Woods G, Shand J, *et al*. Variation in health visiting contacts for children in England: cross-sectional analysis of the 2–2½ year review using administrative data (Community Services Dataset, CSDS). *BMJ Open* 2022;**12**:e053884.



138. Public Health England. *Health Visitor Service Delivery Metrics: 2019 to 2020*. 2021. URL: [www.gov.uk/government/statistics/health-visitor-service-delivery-metrics-2019-to-2020](http://www.gov.uk/government/statistics/health-visitor-service-delivery-metrics-2019-to-2020) (accessed 5 October 2022).
139. Woodman J, Harron K, Hancock D. Which children in England see the health visiting team and how often? *J Health Vis* 2021;**9**:282–4.
140. Doidge JC, Harron KL. Reflections on modern methods: linkage error bias. *Int J Epidemiol* 2019;**48**:203.
141. Morris H, Lanati S, Gilbert R. Challenges of administrative data linkages: experiences of Administrative Data Research Centre for England (ADRC-E) researchers. *Int J Pop Data Sci* 2018;**3**:566.
142. Dattani N, Hardelid P, Davey J, Gilbert R. Accessing electronic administrative health data for research takes time. *Arch Dis Child* 2013;**98**:391–2.
143. Taylor JA, Crowe S, Espuny Pujol F, Franklin RC, Feltbower RG, Norman LJ, *et al*. The road to hell is paved with good intentions: the experience of applying for national data for linkage and suggestions for improvement. *BMJ Open* 2021;**11**:e047575.
144. Cavallaro F, Lugg-Widger F, Cannings-John R, Harron K. Reducing barriers to data access for research in the public interest – lessons from COVID-19. *BMJ Opin* 2020. URL: <https://blogs.bmj.com/bmj/2020/07/06/reducing-barriers-to-data-access-for-research-in-the-public-interest-lessons-from-covid-19/> (accessed 5 October 2022).
145. Harron K. “It Did Mean a Lot”: What Public Engagement with Teenage Mothers Taught Us about Our Research. Contract No.: January 2022. UCL Public Engagement Blog; 2019. URL: <https://blogs.ucl.ac.uk/public-engagement/2019/05/07/engaging-with-teenage-mothers/> (accessed 5 January 2023).
146. Mikton C, Butchart A. Child maltreatment prevention: a systematic review of reviews. *Bull World Health Organ* 2009;**87**:353–61.
147. Vlahovicova K, Melendez-Torres GJ, Leijten P, Knerr W, Gardner F. Parenting programs for the prevention of child physical abuse recurrence: a systematic review and meta-analysis. *Clin Child Fam Psychol Rev* 2017;**20**:351–65.
148. Euser S, Alink LRA, Stoltenborgh M, Bakermans-Kranenburg MJ, van IJzendoorn MH. A gloomy picture: a meta-analysis of randomized controlled trials reveals disappointing effectiveness of programs aiming at preventing child maltreatment. *BMC Public Health* 2015;**15**:1068.
149. Chen M, Chan KL. Effects of parenting programs on child maltreatment prevention: a meta-analysis. *Trauma Violence Abuse* 2016;**17**:88–104.
150. van der Put CE, Assink M, Gubbels J, Boekhout van Solinge NF. Identifying effective components of child maltreatment interventions: a meta-analysis. *Clin Child Fam Psychol Rev* 2018;**21**:171–202.
151. Moniz MH, Low LK, Stout MJ. Intensive nurse home visiting program and adverse birth outcomes. *JAMA* 2022;**328**:23–4.
152. Wilkinson E. Health visitor shortages are risking child health and piling pressure on other services. *BMJ* 2022;**378**:o2189.
153. Dheensa S. *Recording and Sharing Information about Domestic Violence/Abuse in the Health Service*. Bristol: University of Bristol; 2020. URL: [www.standingtogether.org.uk/blog-3/recording-and-sharing-information-about-dva-in-the-health-service-report](http://www.standingtogether.org.uk/blog-3/recording-and-sharing-information-about-dva-in-the-health-service-report) (accessed 5 October 2022).

154. Francetic I, Meacock R, Elliott J, Kristensen SR, Britteon P, Lugo-Palacios DG, *et al.* Framework for identification and measurement of spillover effects in policy implementation: intended non-intended targeted non-targeted spillovers (INTENTS). *Implement Sci* 2022;**3**:30.
155. Lorenc T, Oliver K. Adverse effects of public health interventions: a conceptual framework. *J Epi Com Health* 2014;**68**:288–90.
156. Morrison K, Doi L, Hughes T, Woodier N. *Coronavirus (COVID-19) Family Nurse Partnership Insights: Evaluation Report*. Scottish Government; 2021. URL: [www.research.ed.ac.uk/en/publications/coronavirus-covid-19-family-nurse-partnership-insights-evaluation](http://www.research.ed.ac.uk/en/publications/coronavirus-covid-19-family-nurse-partnership-insights-evaluation) (accessed 13 September 2022).
157. Geospatial Commission. *Unlocking the Power of Location. The UK's Geospatial Strategy, 2020 to 2025*. 2020. URL: [https://assets.publishing.service.gov.uk/government/uploads/system/uploads/attachment\\_data/file/894755/Geospatial\\_Strategy.pdf](https://assets.publishing.service.gov.uk/government/uploads/system/uploads/attachment_data/file/894755/Geospatial_Strategy.pdf) (accessed 10 May 2022).
158. Lut I, Harron K, Hardelid P, O'Brien M, Woodman J. 'What about the dads?' Linking fathers and children in administrative data: a systematic scoping review. *Big Data Soc* 2022;**9**:1069299.
159. Richards JA, Xu D, Gilkerson J, Yapanel U, Gray S, Paul T. Automated assessment of child vocalization development using LENA. *J Speech Lang Hear Res* 2017;**60**:2047–63.
160. Moreno-Betancur M, Lynch JW, Pilkington RM, Schuch HS, Gialamas A, Sawyer MG, *et al.* Emulating a target trial of intensive nurse home visiting in the policy-relevant population using linked administrative data. *Int J Epidemiol*. 2022;**52**:119–131.
161. McGrath-Lone L, Libuy N, Harron K, Jay MA, Wijlaars L, Etoori D, *et al.* Data resource profile: the education and child health insights from linked data (ECHILD) database. *Int J Epidemiol* 2021;**51**:dyab149. <https://doi.org/10.1093/ije/dyab149>
162. RCPCH. *NHS Number as a Unique Identifier for Children – Position Statement*. 2021. URL: [www.rcpch.ac.uk/resources/nhs-number-unique-identifier-children-position-statement](http://www.rcpch.ac.uk/resources/nhs-number-unique-identifier-children-position-statement) (accessed 13 September 2022).
163. Freeguard G, Britchfield C. *Missing Numbers in Children's Services. How Better Data Could Improve Outcomes for Children and Young People*. Institute for Government. 2020. URL: [www.instituteforgovernment.org.uk/sites/default/files/publications/missing-numbers-childrens-services.pdf](http://www.instituteforgovernment.org.uk/sites/default/files/publications/missing-numbers-childrens-services.pdf) (accessed 13 September 2022).



# **Appendix 1** Summary of literature review of effectiveness of Family Nurse Partnership on birth, child and maternal outcomes

TABLE 19 Effectiveness of FNP on birth and child outcomes – summary of the literature

Overall study	Reference	Subgroups	Birth outcomes		Child outcomes												
			Smoking in late pregnancy	Birth-weight	Child abuse/maltreatment reports	Child in care/removed from home	CIN/ CPP	A&E or hospital admissions for injury/maltreatment	All hospital admissions	All A&E attendances	Outpatient referrals	Child development outcomes	Educational achievement	School attendance	Death		
Elmira NY RCT (USA)	Olds (1986)	Age and smoking	-	±													
	Olds (1986)	Poor, unmarried			(-) 2 years				- 2 years		- 2 years			(+) 2 years			
	Olds (1994)	Age and poor and unmarried			0.2-4 years				0.2-4 years	0.2-4 years	- 2 to 4 years			0.2-4 years			
	Eckenrode (2000)	N/A			- 15 years												
	Eckenrode (2017)	Domestic violence			- 15 years												
	Eckenrode (2010)	Poor, unmarried													0, 19 years		
	Olds (1995)	Maltreated			0, 4 years	0, 4 years		0, 4 years	0, 4 years	- 4 years				0, 3/4 years			
	Olds (1994)	Smoking												0, 2 months/2 years + 3/4 years			
Memphis TN RCT (USA)	Kitzman (1997)	Schooling and PIH and LPR		0					0, 2 years								
	Olds (2004)	LPR											+ 6 years	± 6 years			
	Olds (2007)	HPR/LPR												+ 9 years			(-) 9 years
	Olds (2010)	N/A															(+) 12 years
	Olds (2014)	N/A															± 20 years
	Kitzman (2019)	LPR and gender												+ 18 years	+ 18 years		

Overall study	Reference	Subgroups	Birth outcomes		Child outcomes													
			Smoking in late pregnancy	Birth-weight	Child abuse/maltreatment reports	Child in care/removed from home	CIN/CPP	A&E or hospital admissions for injury/maltreatment	All hospital admissions	All A&E attendances	Outpatient referrals	Child development outcomes	Educational achievement	School attendance	Death			
Denver CO RCT <sup>a</sup> (USA)	Olds (2002)	LPR	-										+ 2 years					
	Olds (2004)	LPR											+ 4 years					
	Olds (2014)	LPR											± 6/9 years	0, 6/9 years				
Orange County pilot RCT (USA)	Nguyen (2003)	N/A		-?														
Voor Zorg RCT (NL)	Mejdoubi (2014)	Smoking	-	0														
	Mejdoubi (2015)	Gender and ethnicity			- 3 years													
Pro Kind RCT (DE)	Jungmann (2009)	N/A	0	0									0, 6 months					
	Sierau (2016)	Risk status											+ 2 years					
Building Blocks RCT (England)	Robling (2016)	Deprivation and empl./edu. and life skills	0	0				+ 2 years	0, 2 years	+ 2 years			0, 2 years	+ 2 years				
OH case-control (USA)	Donovan (2007)	Race																- 1 year
OK retrospect. Cohort (USA)	Carabin (2005)	Married and pregnancy risk		±														- 1 year

continued

**TABLE 19** Effectiveness of FNP on birth and child outcomes – summary of the literature (continued)

Overall study	Reference	Subgroups	Birth outcomes		Child outcomes												
			Smoking in late pregnancy	Birth-weight	Child abuse/maltreatment reports	Child in care/removed from home	CiN/CPP	A&E or hospital admissions for injury/maltreatment	All hospital admissions	All A&E attendances	Outpatient referrals	Child development outcomes	Educational achievement	School attendance	Death		
PA retrospect. Cohort (USA)	Matone (2012)	N/A	–														
	Matone (2012)	N/A							± 2 years								
Australia cohort	Segal (2018)	Age and parity			– up to 7 years	– up to 7 years	– up to 7 years										
South Carolina RCT (USA)	McConnell (2022)	Age, edu, mental health; non-Hispanic Black		0													

HPR, high psychological resources; LPR, low psychological resources; PIH, pregnancy-induced hypertension; RCT, randomised controlled trial.  
a Results reported for the nurse intervention arm of the Denver RCT (not the paraprofessional intervention arm).

Legend

Effect observed on whole sample	█	Effect observed in subgroup only	█	No effect	0	Increased	+	Decreased	–
Mixed evidence	±	Weak evidence increase	(+)	Weak evidence decrease	(–)				

**TABLE 20** Effectiveness of FNP on maternal outcomes – summary of the literature

Overall study	Reference	Subgroups	Child abuse perpetration	A&E or hospital admissions for violence/self- harm/drugs/ alcohol	All A&E and hospital admissions	Domestic violence	Drug use/ impairment	Death	Subsequent live births	Subsequent stillbirths	Subsequent birth interval	Educational qualifications
Elmira NY RCT (USA)	Olds (1988)	Age and poor and unmarried							0, 4 years		+ 4 years	+ 6 months 0, 4 years
	Olds (1997)	Poor and unmarried	-15 years				-15 years		-15 years		+ 15 years	
	Eckenrode (2000)	N/A	-15 years			0, 15 years						
	Eckenrode (2017)	Domestic violence							- 15 years			
Memphis TN RCT (USA)	Kitzman (1997)	Schooling and PIH and LPR							- 2 years			
	Kitzman (2000)	HPR							0, 4.5 years	0, 4.5 years	+ 4.5 years	0, 4.5 years
	Olds (2004)	LPR				0, 6 years	0, 6 years		- 6 years		+ 6 years	0, 6 years
	Olds (2007)	HPR/LPR				0, 9 years	(-) 9 years		-9 years		+ 9 years	
	Olds (2010)	N/A				0, 12 years	± 12 years					
	Olds (2014)	N/A						± 20 years				
	Olds (2019)	LPR							0, 18 years			
Denver CO RCT <sup>a</sup> (USA)	Olds (2002)	LPR							- 2 years			0, 2 years
	Olds (2004)	LPR				(-) 4 years	0, 4 years		0, 4 years		+ 4 years	0, 4 years

continued



**TABLE 20** Effectiveness of FNP on maternal outcomes – summary of the literature (continued)

Overall study	Reference	Subgroups	Child abuse perpetration	A&E or hospital admissions for violence/self- harm/drugs/ alcohol	All A&E and hospital admissions	Domestic violence	Drug use/ impairment	Death	Subsequent live births	Subsequent stillbirths	Subsequent birth interval	Educational qualifications
Voor Zorg RCT (NL)	Mejdoubi (2013)	N/A				-32 weeks preg ± 2 years						
Pro Kind RCT (DE)	Sierau (2016)	Risk status							0, 2 years			0, 2 years
Building Blocks RCT (England)	Robling (2016)	Deprivation and employment/ edu and life skills			(+) 2 years							0, 2 years
PA retrosp. Cohort (USA)	Rubin (2011)	Age and urban/ rural							-2 years			
USA entropy balanced cohort	Flowers (2019)	Age										± 1 year

HPR, high psychological resources; LPR, Low psychological resources; PIH, pregnancy-induced hypertension; RCT, randomised controlled trial.  
a Results reported for the nurse intervention arm of the Denver RCT (not the paraprofessional intervention arm).

Legend

Effect observed on whole sample	±	Effect observed in subgroup only	(+)	No effect	0	Increased	+	Decreased	-
Mixed evidence	±	Weak evidence increase	(+)	Weak evidence decrease	(-)				

## Appendix 2 Additional information on creating the linked cohort

### Defining the linked cohort

[Figure 2](#) describes the definition of our cohort of mothers enrolled in the FNP giving birth between 1 April 2010 and 31 March 2019, and their linkage to HES. Of 34,480 FNP mothers in our cohort, 1360 were removed due to patient opt outs of data use in research. We also excluded 670 mothers enrolled in the FNP for their second delivery (e.g. following a previous stillbirth), as well as 310 mothers with FNP pregnancies ending in miscarriage or stillbirth (to ensure comparability with mothers not enrolled in the FNP, since miscarriages are not always captured in routine hospital data), and 105 not meeting age or residential eligibility criteria.

The linkage of FNP mothers to HES records for the remaining 32,040 mothers was performed by NHS Digital. As a first step, the 11% of FNP mothers with missing NHS number in FNP IS data were matched to the NHS Personal Demographics Service spine, using a multistep deterministic algorithm based on first name, last name, date of birth, gender and postcode (see [Table 3](#)). Following NHS number retrieval for cohort members with missing NHS number through this linkage, the proportion of all mothers with missing NHS number was reduced from 11% to 2%.

As a second step, all 32,040 FNP mothers were linked to HES using the standard NHS Digital linkage algorithm (see [Table 4](#)). This is a multistep deterministic linkage algorithm, based on four identifier variables (NHS number, date of birth, gender and postcode). Records matching on match rank 1 have exact agreement on all identifier variables; match ranks 2–8 subsequently allow for partial or no match on some variables, and are therefore less certain matches. Records matching at a given match rank are subsequently removed from the pool of possible matches for subsequent steps.

The availability of valid identifiers was high for FNP mothers included in the linkage ( $n = 32,040$ ), with at most 2.5% missing a valid postcode and 2% missing a valid NHS number (see [Table 5](#)). Among the 505 mothers who did not link to any HESID in NHS Digital's algorithm ( $n = 35$ ) or who were removed after linkage ( $n = 470$ ), availability was high for first name, surname, date of birth and gender; however, 8% were missing a valid NHS number and 4% were missing a valid postcode.

Of the 32,040 mothers included in the linkage attempt, 32,005 (99.9%) were linked to a HESID via NHS Digital's algorithm (see [Figure 1](#)). We excluded 115 of these mothers due to their linked HESIDs not including any records in HES APC, since this indicates a likely error in the way that HESIDs have been assigned internally. Similarly, we excluded 310 mothers with no hospital admission record within one year of giving birth, and 5 with discrepancies in maternal date of birth recorded in HES and FNP IS.

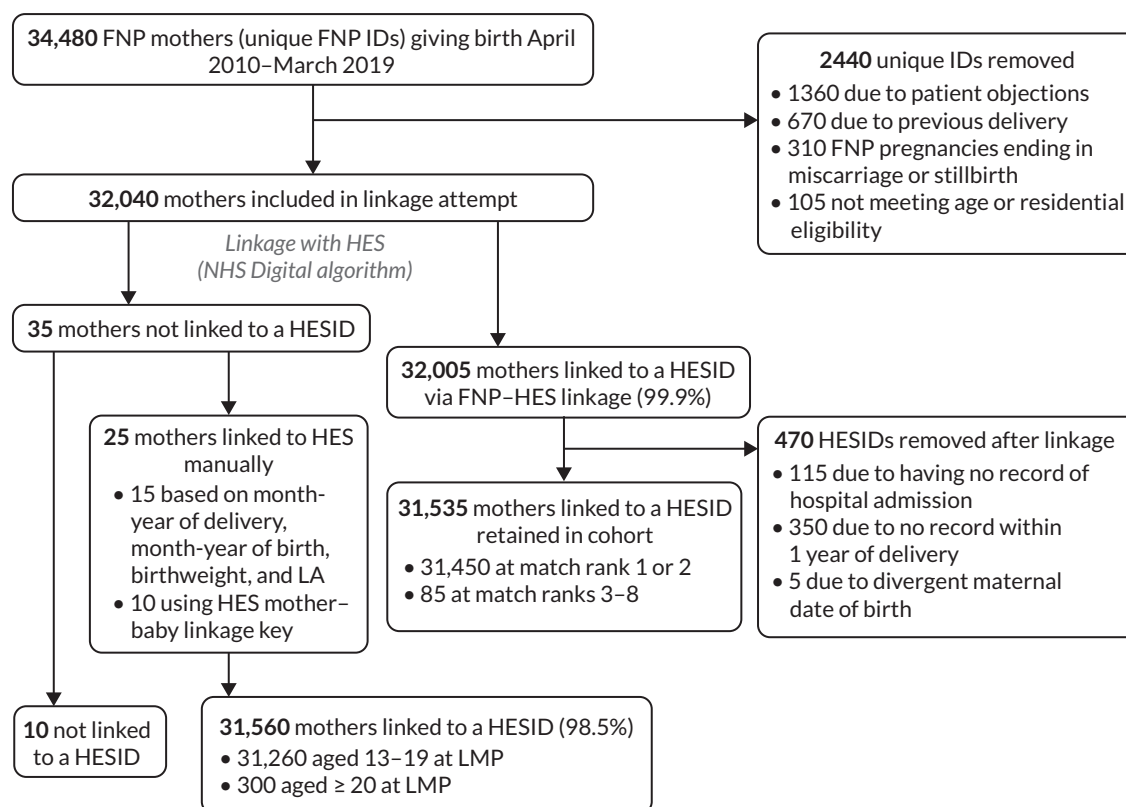
Manual linkage was attempted for the remaining 35 mothers not linked through the NHS Digital algorithm; 15 of these were linked to HES based on agreement on mother's month-year of birth, month-year of delivery, birthweight and LA of residence at the time of birth. A further 10 mothers with missing maternal HESID but available baby HESID were linked to a HESID using the HES mother–baby linkage key. Ten mothers could not be linked manually. The total linkage rate was therefore 31,560 of 32,040 FNP (98.5%) mothers in our cohort.

Characteristics of linkage and unlinked mothers are shown in [Table 6](#).

Agreement between information captured in FNP IS and HES was generally high, with 99% agreement for maternal month-year of birth, delivery month-year and on maternal age at birth (see [Table 7](#)).

Data source	Year of data																			
	2001	2002	2003	2004	2005	2006	2007	2008	2009	2010	2011	2012	2013	2014	2015	2016	2017	2018	2019	
Births																				
FN																				
HES																				
NPD																				
CLA																				
CiN																				
Year of birth of cohort member	1986	15	16	17	18	19	20	21	22	23	24	25	26	27	28	29	30	31	32	33
	1987	14	15	16	17	18	19	20	21	22	23	24	25	26	27	28	29	30	31	32
	1988	13	14	15	16	17	18	19	20	21	22	23	24	25	26	27	28	29	30	31
	1989	12	13	14	15	16	17	18	19	20	21	22	23	24	25	26	27	28	29	30
	1990	11	12	13	14	15	16	17	18	19	20	21	22	23	24	25	26	27	28	29
	1991	10	11	12	13	14	15	16	17	18	19	20	21	22	23	24	25	26	27	28
	1992	9	10	11	12	13	14	15	16	17	18	19	20	21	22	23	24	25	26	27
	1993	8	9	10	11	12	13	14	15	16	17	18	19	20	21	22	23	24	25	26
	1994	7	8	9	10	11	12	13	14	15	16	17	18	19	20	21	22	23	24	25
	1995	6	7	8	9	10	11	12	13	14	15	16	17	18	19	20	21	22	23	24
	1996	5	6	7	8	9	10	11	12	13	14	15	16	17	18	19	20	21	22	23
	1997	4	5	6	7	8	9	10	11	12	13	14	15	16	17	18	19	20	21	22
	1998	3	4	5	6	7	8	9	10	11	12	13	14	15	16	17	18	19	20	21
	1999	2	3	4	5	6	7	8	9	10	11	12	13	14	15	16	17	18	19	20
	2000	1	2	3	4	5	6	7	8	9	10	11	12	13	14	15	16	17	18	19
	2001	0	1	2	3	4	5	6	7	8	9	10	11	12	13	14	15	16	17	18
	2002		0	1	2	3	4	5	6	7	8	9	10	11	12	13	14	15	16	17
	2003			0	1	2	3	4	5	6	7	8	9	10	11	12	13	14	15	16
	2004				0	1	2	3	4	5	6	7	8	9	10	11	12	13	14	15
	2005					0	1	2	3	4	5	6	7	8	9	10	11	12	13	14
	2006						0	1	2	3	4	5	6	7	8	9	10	11	12	13
	-	-	-	-	-	-	-	-	-	-	-	-	-	-	-	-	-	-	-	-
2010										0	1	2	3	4	5	6	7	8	9	
2011											0	1	2	3	4	5	6	7	8	
2012												0	1	2	3	4	5	6	7	
2013													0	1	2	3	4	5	6	
2014														0	1	2	3	4	5	
2015															0	1	2	3	4	
2016																0	1	2	3	
2017																	0	1	2	

**FIGURE 16** Time periods and ages of cohort members included in the study. Shaded boxes indicate age of member during study period (blue); look-back period for health data (grey); follow-up (light blue); and age of child during follow-up (green). The look-back period is the earliest of age 11 (for Key Stage 2 results), or 5 years prior to delivery (in HES).



**FIGURE 17** Description of FNP cohort and linkage to HES.

Agreement was lower for information on birth outcomes, with higher percentages of mothers missing information in at least one data source (e.g. over 30% missing for gestational age at booking appointment, number of babies and sex of baby). Disagreement was high for gestational age at booking appointment (within 2 weeks), with one-third of linked mothers having different information recorded. Of note, 11% of FNP mothers would be considered to be resident in the catchment area of a different FNP site than the one they were registered in at the time of birth, based on the LA of residence recorded in their HES delivery record (or within 12 months of delivery, where missing).

Agreement between data sources was lower for mothers who linked with a match rank higher than 2. This likely reflects lower-quality data in FNP or HES for these mothers, which was also related to more difficulty in linkage. Agreement for maternal month-year of birth was 65% and, as a result of this, agreement was also lower for maternal age at birth (75%), although month-year of delivery agreed for all these mothers. Agreement was lower for ethnicity among mothers linking at match rank > 2 than among all mothers. There were slightly lower rates of agreement for birth outcomes, due primarily to a higher proportion with missing data in at least one data source.

## Mothers aged 20–24

We restricted the 20- to 24-year-old cohort to the 4465 mothers aged 20–24 at LMP living in the catchment area of the 10 FNP sites enrolling  $\geq 10$  mothers in this age group between November 2016 and March 2019 (see [Figure 3](#)). Of these, 4305 (96%) were never enrolled in FNP. We included mothers whose first antenatal appointment (or estimated date of 28 weeks gestation, if date missing) occurred from the month of enrolment of the first mother aged 20–24 in the local site. One hundred and sixty-five mothers aged 20–24 were enrolled in the FNP within these 10 sites; an additional 135 mothers were enrolled in the FNP in sites enrolling < 10 mothers in this age group or before November 2016 and were excluded from analyses.

**TABLE 21** Algorithm used to link FNP cohort members (mothers and children) with missing NHS number to the NHS Personal Demographic Service in order to obtain an NHS number prior to linkage with HES

Match rank	First and last name	Date of birth	Gender	Postcode
1	Exact	Exact	Exact	Exact
2	Soundex	Exact	Exact	Exact
3	Partial	Exact	Exact	Exact
4	Partial	Exact		Exact
5		Exact	Exact	Exact
6	Exact	Exact	Exact	
7	Partial	Exact	Exact	
8	Exact		Exact	Exact

**TABLE 22** Algorithm used to link all FNP cohort members (mothers and children) to HES, following retrieval of missing NHS numbers via the Personal Demographic Service

t	NHS number	Date of birth	Gender	Postcode	
1	Exact	Exact	Exact	Exact	
2	Exact	Exact	Exact		
3	Exact	Partial	Exact	Exact	
4	Exact	Partial	Exact		
5	Exact			Exact	
6		Exact	Exact	Exact	Where NHS does not contradict the match and date of birth is not 1 January and postcode is not in the 'ignore' list
7		Exact	Exact	Exact	Where NHS does not contradict the match and date of birth is not 1 January
8	Exact				

**TABLE 23** Percentage of records with missing valid identifiers for linkage among mothers recorded in the FNP IS from 2010 to 2019

	First name (%)	Surname (%)	NHS number (%)	Date of birth (%)	Gender (%)	Postcode (%)
Mothers - all (n = 32,040)	0	0.03	2.0	0.01	0	2.5
Mothers - unlinked (n = 505)	0	0.2	7.5	0.4	0	3.8

## Linking mothers to their babies in Hospital Episode Statistics

Among the 31,425 FNP mothers in our cohort (31,260 aged 13–19 and 165 aged 20–24 years), 91% were linked to their first baby through a baby HESID recorded in the FNP-HES linkage key (see [Appendix 2, Figure 19](#)). This proportion is somewhat low because some mothers drop out before birth (9% of mothers had no recorded baby FNP ID). Where baby HESID was missing in the FNP-HES mother–baby linkage key, we used the de-identified HES mother–baby linkage key to link an additional 2615 (8%) of FNP mothers in our cohort to a baby HESID.

**TABLE 24** Characteristics of FNP mothers who did and did not link to a HESID

	Total		Linked mothers		Unlinked mothers	
	N	%	N	%	N	%
<b>N (row %)</b>	<b>32,040</b>	<b>100.0</b>	<b>31,560</b>	<b>98.5</b>	<b>480</b>	<b>1.5</b>
Year of delivery						
2010	2085	6.5	2055	6.5	25	5.6
2011	1925	6.0	1870	5.9	55	11.0
2012	2925	9.1	2870	9.1	60	12.1
2013	4130	12.9	4075	12.9	50	10.8
2014	3640	11.4	3600	11.4	40	8.5
2015	5180	16.2	5115	16.2	65	13.5
2016	5360	16.7	5275	16.7	85	17.7
2017	3275	10.2	3225	10.2	50	10.8
2018	2815	8.8	2785	8.8	30	6.7
2019	710	2.2	695	2.2	15	3.1
Maternal age at birth						
13–15	265	0.8	260	0.8	< 8	< 1.7
16–17	11,705	36.5	11,525	36.5	180	37.1
18–19	15,960	49.8	15,735	49.9	225	46.9
20 and above	3990	12.4	3925	12.4	65	13.5
Missing	120	0.4	115	0.4	< 8	< 1.7
Ethnicity						
White	26,490	82.7	26,190	83.0	300	62.9
Asian	755	2.4	730	2.3	25	4.8
Black	1640	5.1	1585	5.0	55	11.7
Mixed/other	2195	6.9	2145	6.8	50	10.4
Missing	960	3.0	910	2.9	50	10.2
Region						
East Midlands	2880	9.0	2825	9.0	55	11.0
East of England	2595	8.1	2575	8.2	20	4.4
London	5030	15.7	4870	15.4	160	32.9
North-East	2185	6.8	2170	6.9	15	3.3
North-West	5130	16.0	5060	16.0	70	15.0
South-East	4605	14.4	4550	14.4	55	11.0
South-West	1860	5.8	1840	5.8	20	4.4
West Midlands	3960	12.4	3915	12.4	50	10.0
Yorkshire and The Humber	3800	11.9	3760	11.9	40	7.9
Relationship status (enrolment)						
In a relationship with biological father	22,710	70.9	22,400	71.0	310	64.2

continued

**TABLE 24** Characteristics of FNP mothers who did and did not link to a HESID (continued)

	Total		Linked mothers		Unlinked mothers	
	N	%	N	%	N	%
In a relationship with other partner	1005	3.1	990	3.1	10	2.5
Single	7370	23.0	7255	23.0	110	23.1
Missing	960	3.0	910	2.9	50	10.2
Living arrangements (enrolment)						
Mother (with or without partner)	16,995	53.0	16,790	53.2	205	42.3
Partner (with or without others, not mother)	6175	19.3	6065	19.2	105	22.3
Relatives/other adults	3130	9.8	3095	9.8	35	7.7
Alone	1860	5.8	1830	5.8	30	6.5
Foster carers/group home/other	2920	9.1	2865	9.1	55	11.0
Missing	960	3.0	910	2.9	50	10.2
Has any GCSEs (enrolment)						
No	10,270	32.1	10,120	32.1	150	31.5
Yes	20,795	64.9	20,515	65.0	280	58.1
Missing	975	3.0	925	2.9	50	10.4
Care leaver (during pregnancy)						
No	30,140	94.1	29,720	94.2	420	87.3
Yes	1185	3.7	1170	3.7	15	2.9
Missing	715	2.2	670	2.1	45	9.8
CiN, CPP or CLA (during pregnancy)						
No	26,510	82.7	26,145	82.8	365	76.0
Yes	4815	15.0	4745	15.0	70	14.2
Missing	715	2.2	670	2.1	45	9.8
Drug and alcohol use during pregnancy (2 weeks before enrolment)						
No	29,165	91.0	28,770	91.2	395	82.3
Yes	1535	4.8	1510	4.8	25	4.8
Missing	1345	4.2	1280	4.1	60	12.9
Gestational age at booking appointment						
Before 10 weeks	19,255	60.1	19,000	60.2	250	52.3
10–20 weeks	10,955	34.2	10,770	34.1	180	37.9
20 weeks or more	1045	3.3	1030	3.3	15	2.7
Missing	790	2.5	755	2.4	35	7.1
<b>Mean number of FNP visits</b>		<b>34.9</b>		<b>35.0</b>		<b>25.8</b>
<b>Note</b> Numbers have been rounded to the nearest 5 in accordance with NHS Digital and DfE's statistical disclosure rules for subnational analyses.						

**TABLE 25** Agreement between information recorded in FNP IS and HES for mothers who linked to a HESID APC record

	Mothers linked with match rank ≤ 2		Linked mothers with match rank > 2 or linked manually	
	N	%	N	%
<b>N (%)</b>	<b>31,450</b>	<b>100.0</b>	<b>110</b>	<b>0.3</b>
Maternal month-year of birth				
Agree	31,265	99.4	70	64.8
Disagree	25	0.1	35	34.3
Missing in at least one source	160	0.6	0	0.9
Delivery month-year				
Agree	31,255	99.4	110	100
Disagree	195	0.6	0	-
Missing in at least one source	0	-	0	-
Maternal age at birth (years)				
Agree	31,135	99.0	80	75.0
Disagree	205	0.7	25	24.1
Missing in at least one source	110	0.4	0	0.9
Ethnicity				
Agree	27,715	88.1	85	78.7
Disagree	2830	9.0	20	17.6
Missing in at least one source	910	2.9	5	3.7
Gestational age at booking appointment (within 2 weeks)				
Agree	11,770	37.4	30	28.7
Disagree	10,575	33.6	40	47.0
Missing in at least one source	9110	29.0	35	34.3
Number of babies				
Agree	21,925	69.7	65	61.1
Disagree	35	0.1	0	-
Missing in at least one source	9495	30.2	40	38.9
Sex of baby				
Agree	20,255	64.4	55	52.8
Disagree	725	2.3	5	2.8
Missing in at least one source	10,475	33.3	50	44.4
Low birthweight				
Agree	24,090	76.6	80	75.0
Disagree	470	1.5	0	0.9
Missing in at least one source	6890	21.9	25	24.1
Gestational age at birth (within 1 week)				
Agree	23,135	73.6	80	75.9
Disagree	730	2.3	0	0.9

continued

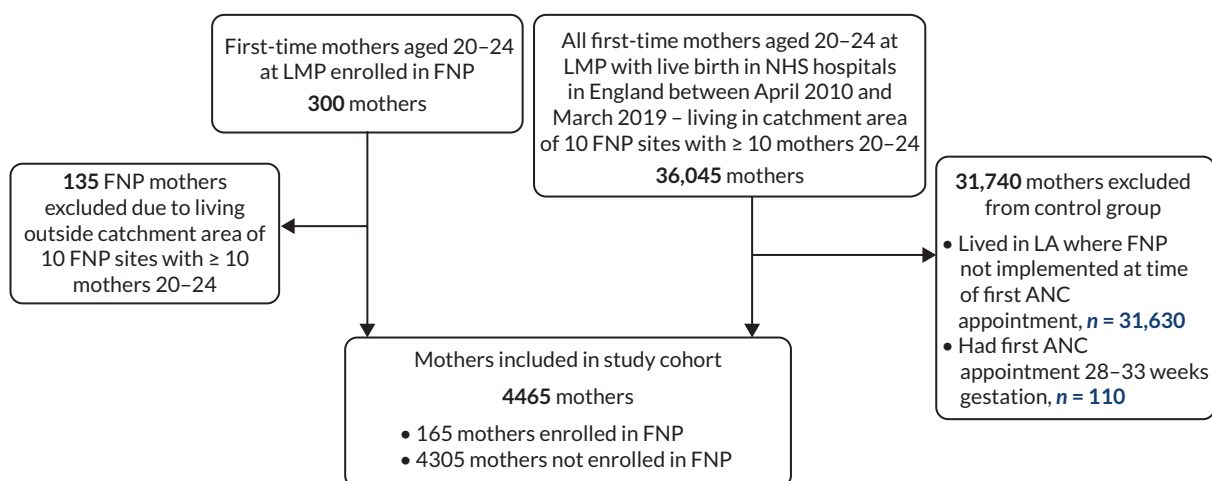


**TABLE 25** Agreement between information recorded in FNP IS and HES for mothers who linked to a HESID APC record (continued)

	Mothers linked with match rank $\leq 2$		Linked mothers with match rank $> 2$ or linked manually	
	N	%	N	%
Missing in at least one source	7590	24.1	25	23.2
FNP site				
Agree	28,095	89.3	90	82.4
Disagree	3360	10.7	20	17.6
Delivery date within FNP site dates				
Agree	30,315	96.4	105	95.4
Disagree	965	3.1	0	-
Missing in at least one source	175	0.6	5	3.7

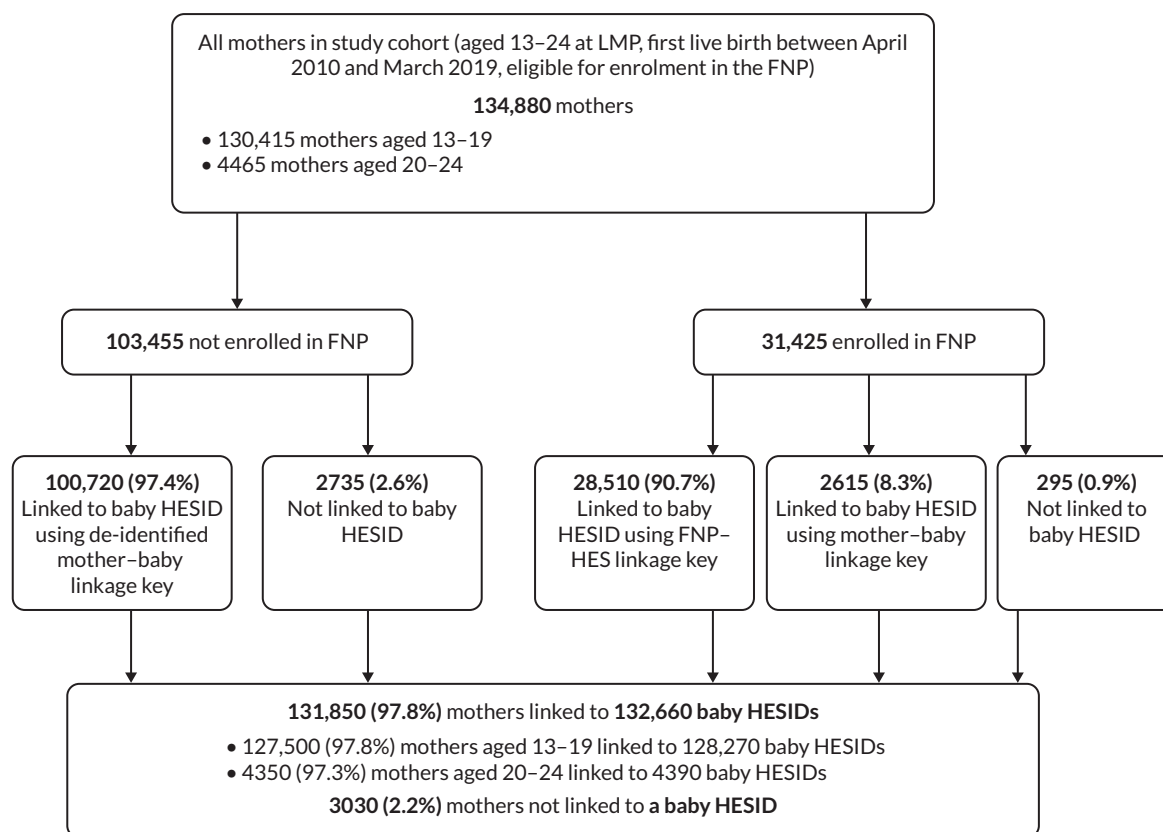
**Note**

FNP site based on recorded LA of residence at the time of delivery in HES.

**FIGURE 18** Identification of FNP participants and comparison group among cohort of mothers aged 20–24. Note: numbers have been rounded to the nearest 5 in accordance with NHS Digital's statistical disclosure rules for subnational analyses; totals may not be equal to the sum of component categories. ANC, antenatal care.

Among the 103,455 mothers in our cohort who were not enrolled in the FNP, 100,720 (97%) were linked to a baby HESID through the de-identified HES mother–baby linkage key. Overall, 131,850 of the 134,880 mothers in our study cohort (97.8%) were linked to a baby HESID for their first birth (see [Appendix 2, Figure 19](#)). This percentage was slightly lower (97.3%) among mothers aged 20–24 than those aged 13–19 (97.8%).

We identified 1025 mothers in our cohort with a multiple birth (0.8% of the 134,880 mothers in our cohort), through recording in FNP IS, or in the mother or baby delivery record in HES. This rate is within the range of 0.65% multiple maternities among mothers aged under 20 and 0.99% among mothers aged 20–24 reported by the ONS in 2019.<sup>3</sup> Among these 1025 mothers with multiple births, 80 (78%) had at least two recorded baby HESIDs, 220 (21%) had only one recorded baby HESID, and 5 (0.5%) had no recorded baby HESIDs. Where only one baby HESID was recorded for a multiple birth, the identified child was retained in the child study cohort.



**FIGURE 19** Linkage of mothers in study cohort to their first child(ren). Note: numbers have been rounded to the nearest 5 in accordance with NHS Digital and DfE’s statistical disclosure rules for subnational analyses; some mothers enrolled in FNP who had a multiple birth may have had one baby identified through the FNP-HES linkage key and another through the de-identified mother-baby linkage key; numbers in subcategories for mothers enrolled in FNP do not add up to the total.

**TABLE 26** Family Nurse Partnership site enrolment activity dates between April 2010 and March 2019 (mothers aged 13–19)

FNP site name	Lower-tier LA(s)	Start date <sup>a</sup>	End date <sup>a</sup>
North-East			
Durham and Darlington	Darlington, County Durham	August 2009	October 2015
Sunderland <sup>b</sup>	Sunderland	August 2009	March 2019
South Tyneside	South Tyneside	January 2010	January 2018
Middlesbrough	Middlesbrough, Redcar and Cleveland	March 2012 April 2012	November 2015 March 2018
Hartlepool	Hartlepool, Stockton-on-Tees	February 2012 April 2012	February 2017 December 2017
Northumberland	Northumberland	March 2014	September 2016
Newcastle upon Tyne	Newcastle-upon-Tyne	April 2014	September 2016
North Tyneside	North Tyneside	March 2014	March 2016
Gateshead	Gateshead	February 2010	March 2019
North West			
Manchester <sup>b</sup>	Manchester	August 2009	September 2016

continued

**TABLE 26** Family Nurse Partnership site enrolment activity dates between April 2010 and March 2019 (mothers aged 13–19) (continued)

FNP site name	Lower-tier LA(s)	Start date <sup>a</sup>	End date <sup>a</sup>
Blackpool	Blackpool	August 2009	March 2019
Cumbria <sup>b</sup>	Allerdale, Barrow-in-Furness, Carlisle, Copeland, Eden, South Lakeland	August 2009	August 2016
Liverpool <sup>b</sup>	Liverpool	August 2009	March 2019
Knowsley	Knowsley	August 2009	March 2019
Wirral	Wirral	August 2009	March 2019
Bolton	Bolton	November 2011	March 2019
Wigan	Wigan	December 2011	March 2019
Cheshire West	Cheshire West and Chester	February 2012	March 2019
Cheshire East	Cheshire East	September 2012	March 2019
Oldham	Oldham	August 2014	March 2019
Stockport	Stockport	August 2014	March 2019
Rochdale	Rochdale	August 2014	February 2017
Bury	Bury	December 2014	March 2019
Halton	Halton	July 2014	March 2019
Salford	Salford	December 2014	March 2019
St Helens	St Helens	December 2014	March 2019
Trafford	Trafford	January 2015	March 2017
Blackburn with Darwen	Blackburn with Darwen	May 2015	April 2016
Lancashire	Burnley, Preston	April 2015	April 2017
Sefton	Sefton	December 2014	September 2016
Tameside	Tameside	March 2015	March 2019
Warrington	Warrington	April 2015	March 2019
Yorkshire and Humber			
Barnsley <sup>b</sup>	Barnsley	August 2009	November 2015
Calderdale	Calderdale	August 2009	February 2016
Hull <sup>b</sup>	Kingston upon Hull, city of	August 2009	June 2017
Leeds <sup>b</sup>	Leeds	August 2009	April 2016
Doncaster	Doncaster	August 2009	March 2016
Kirklees	Kirklees	August 2009	March 2019
Sheffield	Sheffield	August 2009	February 2016
Bradford and Airedale	Bradford	February 2010	March 2019
Rotherham	Rotherham	November 2011	December 2016
Wakefield	Wakefield	November 2011	March 2019
North and North East Lincolnshire	North East Lincolnshire, North Lincolnshire	March 2012	April 2017
East Riding	East Riding of Yorkshire	June 2013	March 2019

**TABLE 26** Family Nurse Partnership site enrolment activity dates between April 2010 and March 2019 (mothers aged 13–19) (*continued*)

FNP site name	Lower-tier LA(s)	Start date <sup>a</sup>	End date <sup>a</sup>
North Yorkshire	Scarborough	June 2013	December 2014
East Midlands			
Derby City <sup>b</sup>	Derby	August 2009	March 2019
Nottingham City	Nottingham	August 2009	March 2019
Northamptonshire <sup>b</sup>	Corby, Daventry, East Northamptonshire, Kettering, Northampton, South Northamptonshire, Wellingborough	August 2009	March 2019
Derbyshire	Amber Valley, Bolsover, Chesterfield, Derbyshire Dales, Erewash, High Peak, North East Derbyshire, South Derbyshire	October 2011	March 2019
Leicester City	Leicester	September 2011	May 2017
Nottinghamshire	Ashfield, Bassetlaw, Broxtowe, Gedling, Mansfield, Newark and Sherwood, Rushcliffe	October 2012	March 2019
Lincolnshire	Boston, East Lindsey	August 2014	February 2016
West Midlands			
Walsall <sup>b</sup>	Walsall	August 2009	September 2016
Stoke-on-Trent	Stoke-on-Trent, Newcastle-under-Lyme	August 2009	October 2016
Coventry <sup>b</sup>	Coventry	August 2009	March 2019
Birmingham <sup>b,c</sup>	Birmingham	January 2013	May 2016
Sandwell	Sandwell	August 2009	January 2017
Telford and Wrekin	Telford and Wrekin	August 2009	March 2019
Solihull	Birmingham, Solihull	August 2009	March 2019
Warwickshire North	North Warwickshire, Nuneaton and Bedworth	November 2010	March 2019
Dudley	Dudley	February 2013	March 2019
Staffordshire – Cannock and Tamworth	Cannock Chase, Tamworth	March 2013	August 2016
East Staffordshire	East Staffordshire	March 2013	April 2017
Shropshire	Shropshire	November 2014	March 2019
Wolverhampton	Wolverhampton	November 2014	July 2017
Warwickshire South and Rugby	Rugby, Stratford-on-Avon, Warwick	November 2010	March 2019
Worcestershire	Bromsgrove, Malvern Hills, Redditch, Worcester, Wychavon, Wyre Forest	September 2015	April 2018
East of England			
South-East Essex <sup>b</sup>	Thurrock, Basildon, Castle Point, Rochford	August 2009 February 2015	October 2016 February 2017
Peterborough and Cambridgeshire	Peterborough, Cambridge, East Cambridgeshire, Fenland, Huntingdonshire, South Cambridgeshire	January 2010 December 2011	March 2019

continued

**TABLE 26** Family Nurse Partnership site enrolment activity dates between April 2010 and March 2019 (mothers aged 13–19) (continued)

FNP site name	Lower-tier LA(s)	Start date <sup>a</sup>	End date <sup>a</sup>
Norfolk	Breckland, Broaland, Great Yarmouth, King's Lynn and West Norfolk, North Norfolk, Norwich, South Norfolk	January 2010	March 2019
Hertfordshire	Broxbourne, Dacorum, East Hertfordshire, Hertsmere, North Hertfordshire, St Albans, Stevenage, Three Rivers, Watford, Welwyn Hatfield	September 2011	February 2016
Suffolk	Ipswich, Suffolk Coastal, Waveney	October 2010 August 2013	March 2018 May 2018 March 2019
North Essex	Braintree, Colchester, Harlow, Tendring	November 2014	November 2016
Bedford and Bedfordshire	Bedford, Central Bedfordshire	January 2015	January 2017
Luton	Luton	September 2015	August 2017
Southend	Southend-on-Sea	August 2009	March 2019
London			
Southwark <sup>b</sup>	Southwark	August 2009	March 2019
Tower Hamlets <sup>b</sup>	Tower Hamlets	August 2009	March 2019
Islington	Islington	August 2009	March 2019
Lambeth <sup>b</sup>	Lambeth	August 2009	March 2019
Ealing	Ealing	August 2009	March 2019
Waltham Forest and Redbridge	Redbridge, Waltham Forest	August 2009 October 2013	March 2019
West Central London	Hammersmith and Fulham, Kensington and Chelsea, Westminster	February 2010	March 2019
Lewisham	Lewisham	January 2010	March 2019
Barking and Dagenham	Barking and Dagenham	November 2010	November 2015
Croydon	Croydon	October 2010	March 2019
Haringey	Haringey	July 2010	March 2019
Barnet	Barnet	November 2011	March 2019
Hounslow	Hounslow	July 2011	March 2019
Enfield	Enfield	November 2013	March 2019
Newham	Newham	September 2013	March 2019
Sutton	Sutton	January 2014	June 2017
Brent	Brent	June 2014	July 2016
Greenwich	Greenwich	April 2014	March 2019
Hackney	Hackney, City of London	May 2014	March 2019
Bromley and Bexley	Bexley, Bromley	September 2014 October 2014	August 2016 March 2019

**TABLE 26** Family Nurse Partnership site enrolment activity dates between April 2010 and March 2019 (mothers aged 13–19) (*continued*)

FNP site name	Lower-tier LA(s)	Start date <sup>a</sup>	End date <sup>a</sup>
Camden	Camden	January 2015	July 2018
Wandsworth	Wandsworth	May 2015	March 2019
Merton	Merton	September 2013	March 2019
South East			
Berkshire East <sup>b</sup>	Bracknell Forest, Slough, Windsor and Maidenhead	August 2009	February 2016
East Sussex – East	Hastings, Rother	August 2009	November 2015 December 2015
Milton Keynes	Milton Keynes	August 2009	October 2016
Southampton	Southampton	August 2009	March 2019
Medway	Medway	August 2009	December 2015
Oxfordshire	Cherwell, Oxford, South Oxfordshire, Vale of White Horse, West Oxfordshire	February 2010	March 2019
East Sussex – West	Eastbourne, Lewes, Wealden	November 2010 March 2011 December 2011	June 2015 November 2015 December 2015
West Sussex	Adur, Arun, Chichester, Crawley, Horsham, Mid Sussex, Worthing	September 2011	March 2019
Portsmouth	Portsmouth	November 2011	March 2019
Kent North	Gravesham, Swale, Thanet	February 2012 December 2014	March 2017 June 2018
Berkshire West	West Berkshire, Reading, Wokingham	November 2012	June 2016
Brighton and Hove	Brighton and Hove	October 2012	March 2016
Buckinghamshire	Aylesbury Vale, Chiltern, South Buckinghamshire, Wycombe	July 2012	March 2019
Kent South	Dover, Maidstone, Shepway, Tonbridge and Malling	February 2013 December 2014	October 2017 June 2018
Surrey	Elmbridge, Epsom and Ewell, Guildford, Mole Valley, Reigate and Banstead, Runnymede, Spelthorne, Surrey Heath, Tandridge, Waverley, Woking	November 2014	March 2019
Hampshire	Basingstoke and Deane, Fareham, Gosport, Hart, Havant, Rushmoor	March 2015 April 2015 August 2015 January 2016	April 2017 March 2018 August 2018 March 2019
South West			
Plymouth	Plymouth	August 2009	March 2019
Cornwall and Isles of Scilly <sup>b</sup>	Cornwall, Isles of Scilly	August 2009	November 2017
Swindon	Swindon	August 2009	March 2019
Bath and North East Somerset	Bath and North East Somerset	February 2013	March 2019

continued

**TABLE 26** Family Nurse Partnership site enrolment activity dates between April 2010 and March 2019 (mothers aged 13–19) (continued)

FNP site name	Lower-tier LA(s)	Start date <sup>a</sup>	End date <sup>a</sup>
Bristol and South Gloucestershire	Bristol, city of, South Gloucestershire	May 2014	March 2019
Bristol and North Somerset	North Somerset	August 2014	August 2015
Wiltshire	Wiltshire	November 2014	March 2019

a Multiple start/end dates indicate different dates in different LAs within FNP sites.  
b Building Blocks trial sites.  
c The Building Block site was South Birmingham.

**TABLE 27** Family Nurse Partnership site enrolment activity dates between April 2010 and March 2019 (mothers aged 20–24)

FNP site name	Lower-tier LA(s)	Start date	End date
North West			
Knowsley	Knowsley	March 2017	March 2019
Yorkshire and Humber			
Bradford and Airedale	Bradford	February 2017	March 2019
London			
Barnet	Barnet	November 2017	March 2019
Ealing	Ealing	May 2017	March 2019
Haringey	Haringey	January 2018	March 2019
Lambeth	Lambeth	February 2017	March 2019
Lewisham	Lewisham	November 2016	March 2019
South East			
Portsmouth	Portsmouth	November 2016	March 2019
South West			
Bath and North East Somerset	Bath and North East Somerset	August 2017	March 2019
Cornwall and Isles of Scilly	Cornwall, Isles of Scilly	November 2016	November 2017

### Linking mothers and babies in the study cohort to National Pupil Database

**TABLE 28** Algorithm used to link mothers and babies in the study cohort to NPD

Match strength	Check(s)
1 (Full confident match)	Full match on names, date of birth, and postcode
2 (Very confident match)	Full match on names, plus combinations of at least two other variables or either fuzzy names/date of birth typo/postcode sector and three other variables
3 (Confident match on a number of variables including fuzzy matching of names/date of birth typo or postcode sector)	Match on either fuzzy names/date of birth typo/postcode sector plus combinations of at least two other variables
4 (Manually checked match on a smaller range of variables and looser fuzzy matching on names/partial postcode)	Lower level of fuzzy matching on names plus combinations of other variables

**TABLE 29** Characteristics of mothers in cohort who linked and did not link to NPD

	All mothers		Linked mothers		Unlinked mothers	
	N	%	N	%	N	%
<b>Total (row %)</b>	<b>134,880</b>	<b>-</b>	<b>112,305</b>	<b>83.3</b>	<b>22,575</b>	<b>16.7</b>
Enrolled in FNP	31,425	23.0	28,330	25.2	3095	13.7
Maternal age at birth						
13-15	2685	2.0	2395	2.1	290	1.3
16-17	26,065	19.3	22,805	20.3	255	14.4
18-19	72,465	53.7	60,970	54.3	11,495	50.9
20-21	30,295	22.5	24,190	21.5	6110	27.1
22-25	3375	2.5	1945	1.7	1425	6.3
Maternal year of birth						
1989	330	0.2	250	0.2	75	0.3
1990	3895	2.9	3110	2.8	785	3.5
1991	8200	6.1	6865	6.1	1335	5.9
1992	12,275	9.1	10,120	9.0	2160	9.6
1993	15,260	11.3	12,535	11.2	2725	12.1
1994	17,080	12.7	14,135	12.6	2940	13.0
1995	17,680	13.1	14,650	13.0	3030	13.4
1996	18,025	13.4	15,040	13.4	2985	13.2
1997	15,985	11.9	13,250	11.8	2730	12.1
1998	12,630	9.4	10,610	9.4	2020	8.9
1999	7810	5.8	6675	5.9	1135	5.0
2000	3695	2.7	3250	2.9	450	2.0
2001	1465	1.1	1315	1.2	150	0.7
2002	420	0.3	385	0.3	40	0.2
2003	105	0.1	95	0.1	-	-
2004	20	0.0	-	-	-	-
Ethnicity						
White	112,280	83.2	97,635	86.9	14,645	64.9
South Asian	4205	3.1	2500	2.2	1710	7.6
Black	5045	3.7	3395	3.0	1650	7.3
Mixed/other	7245	5.4	4650	4.1	2595	11.5
Unknown	6105	4.5	4125	3.7	1980	8.8
Area-level deprivation						
Least deprived	6890	5.1	6125	5.5	765	3.4

continued



**TABLE 29** Characteristics of mothers in cohort who linked and did not link to NPD (*continued*)

	All mothers		Linked mothers		Unlinked mothers	
	N	%	N	%	N	%
2	10,735	8.0	9330	8.3	1410	6.2
3	18,690	13.9	15,805	14.1	2880	12.8
4	33,900	25.1	28,030	25.0	5870	26.0
Most deprived	64,505	47.8	52,890	47.1	11,615	51.5
Unknown	165	0.1	125	0.1	40	0.2
Admission with diagnoses within 2 years before 20 weeks of pregnancy						
Mental health (excluding substance misuse and self-harm)	3425	2.5	3055	2.7	365	1.6
Adversity-related	5540	4.1	4925	4.4	615	2.7
Any chronic condition	12,245	9.1	10,885	9.7	1360	6.0
Any A&E attendance	84,785	62.9	73,130	65.1	11,655	51.6
Non-attendance at ≥ 1 outpatient appointment	38,755	32.7	32,870	32.7	5890	33.1
Gestational age at booking						
Before 10 weeks	36,095	26.8	31,730	28.3	4365	19.3
10–20 weeks	49,225	36.5	40,905	36.4	8320	36.9
20 weeks or more	7480	5.5	5680	5.1	1800	8.0
Unknown	42,080	31.2	33,990	30.3	8090	35.8

**TABLE 30** Characteristics of FNP mothers in cohort who linked and did not link to NPD (from information recorded in FNP IS)

	All mothers		Linked mothers		Unlinked mothers	
	N	%	N	%	N	%
<b>Total</b>	<b>31,425</b>	<b>-</b>	<b>28,330</b>	<b>90.2</b>	<b>3095</b>	<b>9.8</b>
Living arrangements at enrolment						
Alone	1810	5.8	1585	5.6	225	7.3
Foster carers/group home/other	2845	9.1	2510	8.9	335	10.8
Mother (with or without partner)	16,750	53.3	15,490	54.7	1260	40.7
Partner (with or without others, not mother)	6035	19.2	5160	18.2	875	28.3
Relatives/other adults	3080	9.8	2785	9.8	295	9.5
Unknown	905	2.9	795	2.8	110	3.6
Relationship status at enrolment						
In a relationship with biological father	22,310	71.0	20,105	71.0	2205	71.2
In a relationship with other partner	990	3.2	915	3.2	75	2.4
Single	7220	23.0	6510	23.0	710	22.9

**TABLE 30** Characteristics of FNP mothers in cohort who linked and did not link to NPD (from information recorded in FNP IS) (continued)

	All mothers		Linked mothers		Unlinked mothers	
	N	%	N	%	N	%
Unknown	905	2.9	795	2.8	110	3.6
Alcohol/drug use at enrolment						
No	28,650	91.2	25,840	91.2	2805	90.6
Yes	1500	4.8	1360	4.8	140	4.5
Unknown	1275	4.1	1130	4.0	150	4.8
Care leaver during pregnancy						
No	29,605	94.2	26,720	94.3	2885	93.2
Yes	1155	3.7	1030	3.6	125	4.0
Unknown	665	2.1	580	2.0	85	2.7
CiN, CPP, or Looked After during pregnancy						
No	26,035	82.8	23,425	82.7	2610	84.3
Yes	4725	15.0	4325	15.3	400	12.9
Unknown	665	2.1	580	2.0	85	2.7
Gestational age at booking appointment						
Before 10 weeks	18,915	60.2	17,180	60.6	1730	55.9
10–20 weeks	10,730	34.1	9590	33.9	1145	37.0
20 weeks or more	1030	3.3	890	3.1	140	4.5
Unknown	750	2.4	670	2.4	80	2.6

**TABLE 31** Characteristics of children in cohort who linked and did not link to NPD

	All babies		Linked babies		Unlinked babies	
	N	%	N	%	N	%
<b>Total (row %)</b>	<b>132,660</b>	<b>-</b>	<b>89,580</b>	<b>67.5</b>	<b>43,080</b>	<b>32.5</b>
Baby year of birth						
2010	9945	7.5	9220	10.3	725	1.7
2011	13,485	10.2	12,595	14.1	890	2.1
2012	15,485	11.7	14,500	16.2	990	2.3
2013	16,385	12.4	15,225	17.0	1160	2.7
2014	15,885	12.0	14,565	16.3	1320	3.1
2015	17,655	13.3	15,150	16.9	2505	5.8
2016	16,515	12.4	8315	9.3	8200	19.0
2017	13,375	10.1	10	0.0	13,365	31.0
2018	11,520	8.7	-	-	-	-
2019	2405	1.8	-	-	-	-

continued

**TABLE 31** Characteristics of children in cohort who linked and did not link to NPD (*continued*)

	All babies		Linked babies		Unlinked babies	
	N	%	N	%	N	%
Maternal ethnicity						
White	110,530	83.3	77,385	86.4	33,145	76.9
South Asian	4120	3.1	2360	2.6	1760	4.1
Black	4925	3.7	3105	3.5	1815	4.2
Mixed/other	7075	5.3	4045	4.5	3030	7.0
Unknown	6015	4.5	2685	3.0	3325	7.7
Area-level deprivation						
Least deprived	6810	5.1	4455	5.0	2355	5.5
2	10,590	8.0	6935	7.7	3650	8.5
3	18,430	13.9	12,005	13.4	6425	14.9
4	33,285	25.1	22,170	24.7	11,110	25.8
Most deprived	63,390	47.8	43,925	49.0	19,465	45.2
Unknown	165	0.1	90	0.1	70	0.2

## Appendix 3 International Classification of Diseases, 10th Revision code lists

### International Classification of Diseases, 10th Revision code lists for maternal hospital admissions related to adversity, mental health and chronic conditions

Code lists were derived from the following studies:

- Harron K, Gilbert R, Fagg J, Guttmann A, van der Meulen J. Associations between pre-pregnancy psychosocial risk factors and infant outcomes: a population-based cohort study in England. *Lancet Public Health* 2021;**6**(2):e97–105.
- Herbert A, Gilbert R, González-Izquierdo A, Li L. Violence, self-harm and drug or alcohol misuse in adolescents admitted to hospitals in England for injury: a retrospective cohort study. *BMJ Open* 2015;**5**(2):e006079.
- Hardelid P, Dattani N, Gilbert R. Estimating the prevalence of chronic conditions in children who die in England, Scotland and Wales: a data linkage cohort study. *BMJ Open* 2014;**4**(8):e005331.
- Pearson RJ, Jay MA, Wijlaars LPMM, De Stavola B, Syed S, Bedston SJ, Gilbert R. Association between health indicators of maternal adversity and the rate of infant entry to Local Authority care in England: a longitudinal ecological study. *BMJ Open* 2020;**10**(8):e036564.

Unplanned maternal hospital admissions with any of the ICD-10 codes in the following respective categories were considered to be adversity-related or mental health-related. Mothers with any hospital admissions relating to a chronic condition were considered to have a chronic condition.

Group	Description	ICD10 code
<b>Adversity-related admissions</b>		
Violence	Maltreatment syndromes	T74
	Effects of other deprivation (extreme neglect)	T73
	Perpetrator of neglect and other maltreatment syndromes	Y06, Y07
	Assault by bodily force and sexual assault	Y04, Y05
	Other types of assault	X85–Y03, Y08–Y09
	Events of undetermined intent	Y20–Y34
	Examination and observation following other inflicted injury	Z04.5
	Examination and observation for other reasons: request for expert evidence	Z04.8

Group	Description	ICD10 code	
Self-harm	Sequelae of intentional self-harm	Y87.0	
	Intentional self-poisoning by and exposure to ... drugs	X60-X63	
	... other and unspecified drugs, medicaments and biological substances	X64	
	... alcohol	X65	
	... organic solvents and halogenated hydrocarbons and their vapours	X66	
	... other gases and vapours	X67	
	... pesticides	X68	
	... other and unspecified chemicals and noxious substances	X69	
	Intentional self-harm by ... hanging, strangulation and suffocation	X70	
	... drowning and submersion	X71	
	... firearm discharge	X72-X74	
	... explosive material	X75	
	... smoke, fire and flames, or steam, hot vapours and hot objects	X76-X77	
	... sharp/blunt objects	X78-X79	
	... jumping from a high place	X80	
	... jumping or lying before a moving object, or crashing a motor vehicle	X81-82	
	... other specified means	X83	
	... unspecified means	X84	
	Substance misuse	Mental and behavioural disorders due to psychoactive substance use	F11-F16, F19
		Finding of drugs not normally found in blood	R78.1-R78.5
Poisoning by drugs, medicaments and biological substances		T36-T50 (not T50.6)	
Poisoning, undetermined intent		Y10-Y14	
Drug rehabilitation		Z50.3	
Drug abuse counselling and surveillance		Z71.5	
Drug use		Z72.2	
Mental and behavioural disorders due to use of volatile solvents		F18	
Accidental poisoning by and exposure to noxious substances		X40-X44, X46-X49	
Poisoning by chemical or noxious substance, undetermined intent		Y16-Y19	
Special epileptic syndromes (related to alcohol, drugs, etc.)		G40.5	
Blood-alcohol and blood-drug test		Z04.0	
Alcohol-induced pseudo-Cushing syndrome		E24.4	
Mental and behavioural disorders due to use of alcohol		F10	
Degeneration of nervous system due to alcohol		G31.2	
Alcoholic polyneuropathy		G62.1	
Alcoholic myopathy		G72.1	
Alcoholic cardiomyopathy		I42.6	
Alcoholic gastritis	K29.2		

Group	Description	ICD10 code
	Alcoholic liver disease	K70
	Alcohol-induced acute pancreatitis	K85.2
	Alcohol-induced chronic pancreatitis	K86.0
	Maternal care for (suspected) damage to fetus from alcohol	O35.4
	Finding of alcohol in blood	R78.0
	Poisoning: antidotes and chelating agents, not elsewhere classified	T50.6
	Toxic effect of alcohol	T51
	Accidental poisoning by exposure to alcohol	X45
	Poisoning by exposure to alcohol, undetermined intent	Y15
	Evidence of alcohol involvement determined by blood alcohol level	Y90
	Evidence of alcohol involvement determined by level of intoxication	Y91
	Alcohol rehabilitation	Z50.2
	Alcohol abuse counselling and surveillance	Z71.4
	Alcohol use	Z72.1
<b>Mental health conditions/behavioural disorders (excluding those falling under adversity or chronic conditions)</b>		
	Organic, including symptomatic, mental disorders	F00–F09 <sup>a</sup>
	Schizophrenia, schizotypal and delusional disorders	F20–F29
	Mood [affective] disorders	F30–F39
	Neurotic, stress-related and somatoform disorders	F40–F48
	Behavioural syndromes associated with physiological disturbances and physical factors	F50–F59 <sup>b</sup>
	Disorders of adult personality and behaviour	F60–F69 <sup>c</sup>
	Mental retardation	F70–F79
	Disorders of psychological development	F80–F89
	Behavioural and emotional disorders with onset usually occurring in childhood and adolescence	F90–F98
	Sedatives, hypnotics and antianxiety drugs	Y47
	Psychotropic drugs, not elsewhere classified	Y49
<b>Chronic conditions (except those falling under mental health conditions)</b>		
Cancer/blood disorders	Neoplasms	C00–C97, D00–D02, D05–D09, D12, D13, D14.1–D14.4, D15, D20, D32–D35, D37–D48, D63.0, E34.0, E88.3, G13.0, G13.1, G53.3, G55.0, G63.1, G73.1, G73.2, G94.1, M36.0, M36.1, M49.5, M82.0, M90.6, M90.7, N08.1, N16.1, Y43.1–Y43.3, Y84.2, Z08, Z51.0–Z51.2, Z54.1, Z54.2, Z85, Z86.0, Z92.3

Group	Description	ICD10 code
	Immunological disorders	D80–D84, G53.2, Q98.0
	Anaemia and other blood disorders	D50, D56.0–D56.2, D56.4, D56.8, D56.9, D57.0–D57.2, D57.8, D58, D61.0, D61.9, D64, D66, D67, D68.0–D68.2, D68.4–D68.9, D69, D70–D76, M36.2–M36.4, M90.4, N08.2, Z86.2
Chronic infections	HIV	B20–B24, F02.4, R75, Z21
	Tuberculosis	A15–A19, E35.0, K23.0, K67.3, K93.0, M01.1, M49.0, P37.0
	Other	A50, A81, B18, B37.1, B37.5, B37.6, B37.7, B38.1, B39.1, B40.1, B44.0, B44.7, B45, B46, B48.7, B50.0, B50.8, B51.0, B51.8, B52.8, B52.0, B55, B57.2–B57.5, B58.0, B59, B67, B69, B73, B74, B78.7, B90–B94, F02.1, K23.1, K93.1, M00, N33.0, P35.0–P35.2, P35.8, P35.9, P37.1
Respiratory	Asthma and chronic lower respiratory disease	J41–J47
	Cystic fibrosis	E84, P75
	Injuries	S17, S27, S28, T27, T91.4
	Congenital anomalies	Q30–Q37, Q79.0
	Other	G47.3, J60–J70, J80–J86, J96.1, J98, P27, Y55.6, Z43.0, Z93.0, Z94.2
Metabolic/endocrine/ digestive/renal/ genitourinary	Diabetes	E10–E14, G59.0, G63.2, I79.2, M14.2, N08.3, O24, Y42.3
	Other endocrine	E00, E03.0, E03.1, E07.1, E22.0, E23.0, E25, E26.8, E29.1, E31, E34.1, E34.2, E34.5, E34.8, G13.2, G73.5, Y42.1

Group	Description	ICD10 code
	Digestive	K20, K21.0, K22, K23.8, K25–K28, K29.0, K29.1, K29.3–K29.9, K31, K50–K52, K55, K57, K59.2, K63.0–K63.3, K66, K72–K76, K80–K83, K85.0, K85.1, K85.8, K85.9, K86.1–K86.9, K87.0, K90, M07.4, M07.5, M09.1, M09.2, T86.4, Z43.2–Z43.4, Z46.5, Z90.3, Z90.4, Z93.2–Z93.5
	Renal/genitourinary	D63.8, G63.8, G99.8, I68.8, M90.8, N08.4, N00–N05, N07, N11–N15, N16.0, N16.2, N16.4, N16.5, N16.8, N18, N19, N20–N23, N25, N26, N28, N29, N31, N32, N33.8, N35, N36, N39.1, N39.3, N39.4, N40–N42, N70–N74, N80–N82, N85, N86, N87, N88, P96.0, T82.4, T83.1, T83.2, T83.4–T83.9, T85.5, T86.1, Y60.2, Y61.2, Y62.2, Y84.1, Z49, Z93.6, Z94.0, Z99.2
	Congenital anomalies of the digestive/renal/genitourinary system	Q38.0, Q38.3, Q38.4, Q38.6–Q38.8, Q39, Q40.2, Q40.3, Q40.8, Q40.9, Q41, Q42, Q43.1, Q43.3–Q43.7, Q43.9, Q44, Q45, Q50.0, Q51, Q52.0–Q52.2, Q52.4, Q54.0–Q54.3, Q54.8, Q54.9, Q55.0, Q55.5, Q56, Q60.1, Q60.2, Q60.4–Q60.6, Q61, Q62.0–Q62.6, Q62.8, Q63.0–Q63.2, Q63.8, Q63.9, Q64, Q79.2–Q79.5, Q87.8, Q89.1, Q89.2
	Injuries	S36, S37, S38, S39.6, S39.7, T06.5, T28, T91.5
	Other/unspecified	E66, G63.3, G99.0, M14.5, N92, Z86.3, Z93.8



Group	Description	ICD10 code
Musculoskeletal/skin	Musculoskeletal/connective tissue	G55.1–G55.3, G63.5, G63.6, G73.7, J99.0, J99.1, L62.0, M05, M06, M07.0–M07.3, M07.6, M08, M09.8, M10–M13, M14.0, M14.6, M14.8, M30–M35, M40–M43, M45–M48, M50–M54, M60–M62, M63.8, M80.1–M80.9, M81.1–M81.9, M82.1, M82.8, M84.0–M84.2, M84.8, M84.9, M85, M86.3–M86.6, M89, M90.0, M91–M94, N08.5, Y45.4
	Skeletal injuries/amputations	S13, S22.0–S22.2, S22.5, S23, S32, S33, S68.3, S68.4, S68.8, S77, S78, S87, S88, S97, S98.0, S98.2–S98.4, T02, T04, T05, T20.3, T20.7, T21.3, T21.7, T22.3, T22.7, T23.2, T23.3, T23.6, T23.7, T24.3, T24.7, T25.2, T25.3, T25.6, T25.7, T29.3, T29.7, T30.3, T30.7, T31.2–T31.9, T32.2–T32.9, T87.3–T87.6, T91.2, T91.8, T92.6, T93.1, T93.4, T93.6, T94.0, T94.1, T95.0, T95.1, T95.4, T95.8, T95.9, Y83.5, Z89.1, Z89.2, Z89.5–Z89.8, Z97.1
	Chronic skin disorders	L10, L11.0, L11.8, L11.9, L12–L14, L28, L40–L45, L57, L58.1, L59, L87, L88, L90, 3 L92, L95, L93, L98.5, M09.0, Q80, Q81, Q87.0–Q87.5, Q89.4
	Congenital anomalies	Q18.8, Q65.0–Q65.2, Q65.8, Q65.9, Q67.5, Q68.2, Q68.3–Q68.5, Q71–Q73, Q74, Q75.3–Q75.9, Q76.1–Q76.4, Q77, Q78, Q79.6, Q79.8, Q82.0–Q82.4, Q82.9, Q86.2, Q89.7–Q89.9
	Neurological	Epilepsy
	Cerebral palsy	G80–G83

Group	Description	ICD10 code
	Injuries of brain, nerves, eyes or ears	S05–S08, S12, S14, S24, S34, S44, S54, S64, S74, S84, S94, T06.0–T06.2, T26, T90.4, T90.5, T91.1, T91.3, T92.4
	Chronic eye conditions	H05.1–H05.9, H13.3, H17, H18, H19.3, H19.8, H21, H26, H27, H28.0–H28.2, H31, H32.8, H33, H34, H35, H40, H42.0, H43, H44, H47, H54.0–H54.2, H54.4, T85.2, T85.3, Z44.2
	Chronic ear conditions	H60.2, H65.2–H65.4, H66.1–H66.3, H69.0, H70.1, H73.1, H74.0–H74.3, H75.0, H80, H81.0, H81.4, H83.0, H83.2, H90.0, H90.3, H90.5, H90.6, H91, Z45.3
	Perinatal conditions	P10, P21.0, P52, P57, P90, P91.1, P91.2, P91.6
	Congenital anomalies of neurological or sensory systems	Q00–Q07, Q10.4, Q10.7, Q11–Q12, Q13.0–Q13.4, Q13.8, Q13.9, Q14–Q16, Q75.0, Q75.1, Q85, Q86.0, Q86.1, Q86.8, Q90–Q93, Q95.2, Q95.3, Q97, Q99
	Other	F02.2, F02.3, G00–G09, G10–G12, G13.8, G14, G20–G23, G24.1–G24.9, G25–G30, G31.0–G31.1, G31.8, G31.9, G32–G37, G43–G46, G47.0–G47.2, G47.4–G47.9, G50–G52, G53.0, G53.1, G53.8, G54, G55.8, G56–G58, G59.8, G60, G61, G62.0, G62.2–G62.9, G64, G70, G71, G72.2–G72.9, G73.0, G73.3, G90–G93, G94.2, G94.8, G95, G96, G98, G99.1, G99.2, I60–I67, I68.0, I68.2, I69, I72.0, I72.5, T85.0, T85.1, Y46.7–Y46.8, Z98.2

Group	Description	ICD10 code
Cardiovascular	Congenital heart disease	Q20–Q26, Q89.3
	Other	I00–I28, I31–I39, I41, I42.0–I42.5, I42.7–I42.9, I43.0, I43.1, I43.2–I43.8, I44.1–I44.7, I45.1–I45.9, I46–I51, I52.8, I70–I71, I72.1–I72.4, I72.8, I72.9, I73–I77, I79.0, I79.1, I79.8, I81–I82, I98–I99, M03.6, N08.8, Q27, Q28, S26, T82.0–T82.3, T82.5–T82.9, T86.2, Y60.5, Y61.5, Y62.5, Y84.0, Z45.0, Z50.0, Z94.1, Z95
Codes indicating non-specific chronic conditions	-	R62, R63.3, Z43.1, Z51.5, Z75.5, Z93.1, Z99.3

a Excluding F020–F024 (dementia codes).

b Excluding F51 (nonorganic sleep disorders) and F52 (sexual dysfunction, not caused by organic disorder or disease).

c Excluding F64 [gender identity disorders (including transsexualism, transvestism, and 'gender disorders')].

### **International Classification of Diseases, 10th Revision code lists for child maltreatment and healthcare utilisation-related outcomes**

Code lists were derived from the following studies:

- Gilbert R, Fluke J, O'Donnell M, Gonzalez-Izquierdo A, Brownell M, Gulliver P, *et al.* Child maltreatment: variation in trends and policies in six developed countries. *Lancet* 2012;**379**(9817):758–72. [https://doi.org/10.1016/S0140-6736\(11\)61087-8](https://doi.org/10.1016/S0140-6736(11)61087-8)
- Syed S, Ashwick R, Schlosser M, Gonzalez-Izquierdo A, Li L, Gilbert R. Predictive value of indicators for identifying child maltreatment and intimate partner violence in coded electronic health records: a systematic review and meta-analysis. *Arch Dis Child* 2021;**106**:44–53.
- Robling M, Lugg-Widger F, Cannings-John R, Sanders J, Angel L, Channon S, *et al.* The Family Nurse Partnership to reduce maltreatment and improve child health and development in young children: the BB:2–6 routine data-linkage follow-up to earlier RCT. *Public Health Res* 2021;**9**(2). URL: <https://journalslibrary.nihr.ac.uk/phr/phr09020/#/abstracthttps://www.journalslibrary.nihr.ac.uk/phr/phr09020/#/abstract>

Unplanned hospital admissions with any of the ICD-10 codes in the following respective categories were considered to be maltreatment or injury related:

Group	Description	ICD-10 code	Age restriction
<b>Maltreatment and injury-related</b>			
Injury and ingestion	Injuries to the head (includes open wounds, fractures, crushing and dislocation)	S00–S09	N/A
	Injuries to the neck	S10–S19	N/A
	Injuries to the thorax	S20–S29	N/A
	Injuries to the abdomen, lower back, lumbar spine and pelvis	S30–S39	N/A
	Injuries to the shoulder and upper arm	S40–S49	N/A
	Injuries to the elbow and forearm	S50–S59	N/A

Group	Description	ICD-10 code	Age restriction
	Injuries to the wrist and hand	S60-S69	N/A
	Injuries to the hip and thigh	S70-S79	N/A
	Injuries to the knee and lower leg	S80-S89	N/A
	Injuries to the ankle and foot	S90-S99	N/A
	Injuries involving multiple body regions	T00-T07	N/A
	Injuries to unspecified part of trunk, limb or body region	T08-T14	N/A
	Effects of foreign body entering through natural orifice	T15-T19	N/A
	Burns and corrosions	T20-T32	N/A
	Frostbite	T33-T35	N/A
	Poisoning by drugs, medicaments and biological substances	T36-T50	N/A
	Toxic effects of substances chiefly non-medicinal as to source (sting, alcohol, solvents, etc.)	T51-T65	N/A
	Other and unspecified effects of external causes (effects of radiation, heat and light, hypothermia, electric shock, asphyxiation, food deprivation)	T66-T78	N/A
	Accidental poisoning by and exposure to noxious substances	X40-X49	N/A
Maltreatment	Maltreatment syndromes	T74	N/A
	Neglect and abandonment	Y06	N/A
	Other maltreatment	Y07	N/A
	Effects of other deprivation (hunger, thirst, exhaustion due to exposure or excessive exertion)	T73	N/A
	Assault	X85-Y05 Y08-Y09	N/A
Maltreatment markers for infants < 1 year	Intracranial injuries	S06	< 1 year
	Long-bone fractures	S42.2-S42.4, S42.7-S42.8, S52, S72, S82, T10, T12	< 1 year
Maltreatment markers for children ≤ 4 years	Traumatic brain injuries	S06, S09.7-S09.8, T90.5	≤ 4 years
	Retinal haemorrhage	H35.6	≤ 4 years
	Rib fractures	T29-T32	≤ 4 years



## Appendix 4 Additional information on methods for Objective 3

In order to calculate the denominator (time at risk) for fidelity target calculations, we first cleaned the dates used in these calculations, including enrolment dates, completion dates, leaving and returning dates. A nurse will record a completion date if the client has come to the end of the programme (which will most likely be at the child's second birthday, although may be sooner if agreed, such as in ADAPT sites). A leaving date is recorded if the client leaves the programme earlier than is planned, which should be recorded alongside one of the following reasons: client moves out of programme area, the child is no longer with the client (e.g. moved into care), death (maternal, fetal or infant). If a client becomes uncontactable or refuses the programme, they will be recorded as inactive, and a leaving date is also recorded.

### *Issues with completion dates*

Prior to cleaning, 20,560 (73.0%) of the 28,155 mothers enrolled in the FNP had a completion date recorded. Of these, 18,245 had more than one completion date recorded. Most (10,450; 57.3%) of these were duplicated dates and were deleted. For the remaining 7795 individuals, we chose the latest completion date recorded closest to the last visit date recorded.

Seven thousand six hundred and fifteen completion dates were recorded earlier than expected (i.e. before the child's second birthday). Four thousand four hundred and sixty of these had a leaving date recorded on the same day as the completion date, and for these, we retained the leaving date. For the remaining 3155 with no leaving date recorded, the majority (2855; 90.5%) left when the child was aged 21–24 months old. Only 300 had completion dates when the child was younger than 21 months. There was evidence that these clustered around ADAPT sites, where early completion was possible.

Four thousand six hundred and thirty-five mothers had a completion date that was more than 1 month after the last visit. For these, we truncated the completion date to 1 month after the last visit, as we assumed the mothers had effectively left the programme following their last visit.

Four thousand four hundred and five clients had a completion date more than 1 month after the child's second birthday. Most of these (4170, 94.7%) had a 24-month visit recorded. Since we assumed that these mothers had left the programme at this point, we updated the completion date for all of these to the child's second birthday.

Two hundred and twenty clients had no completion date, but a leaving date when the child was 23 months old or older. These were considered to have completed at the child's second birthday and completion dates were updated to the leaving date.

Two hundred and thirty-five clients had no completion or leaving date. Sixty-five of these had visit dates up until the child's second birthday. For these, we updated the completion date to the final visit date. For the remaining 170, we created a leaving date at 2 weeks after the final visit date.

After cleaning, 16,305 clients (57.9%) had a completion date.

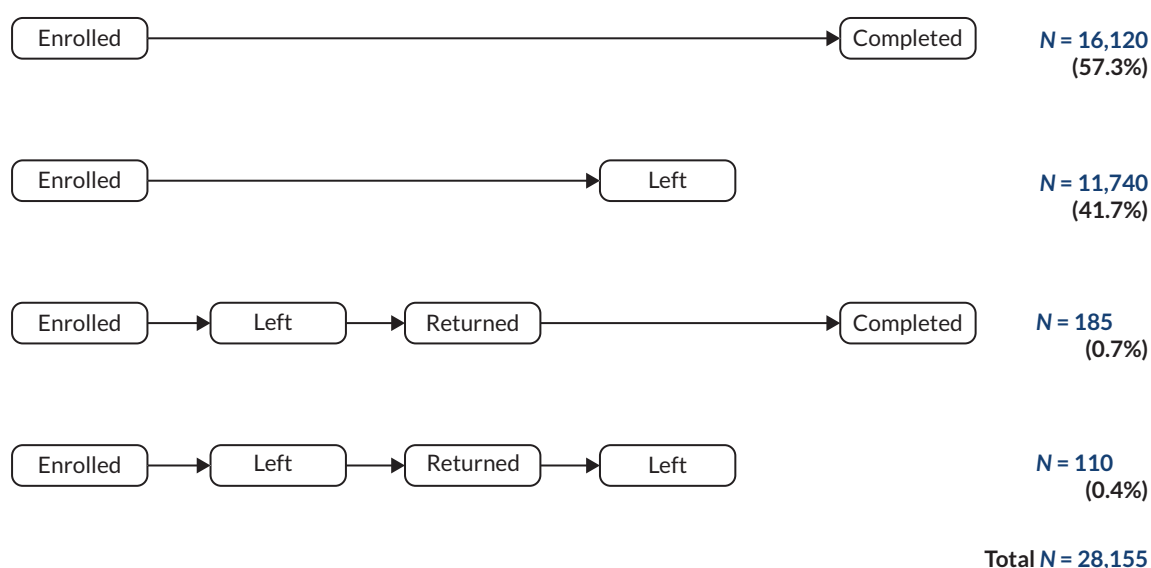
### *Issues with leaving and returning dates*

Of the 28,155 mothers enrolled in the FNP, 12,145 (43.1%) had at least one leaving date recorded and 4870 (17.3%) had at least one returning date. The combinations of these dates were cleaned to ensure that there were no duplicates and that they could fit into a logical sequence. Four thousand one hundred and seventy had leaving and returning dates on the same day, no completion date and no visits recorded after the returning date, therefore we kept only the leaving date. There were individuals with small

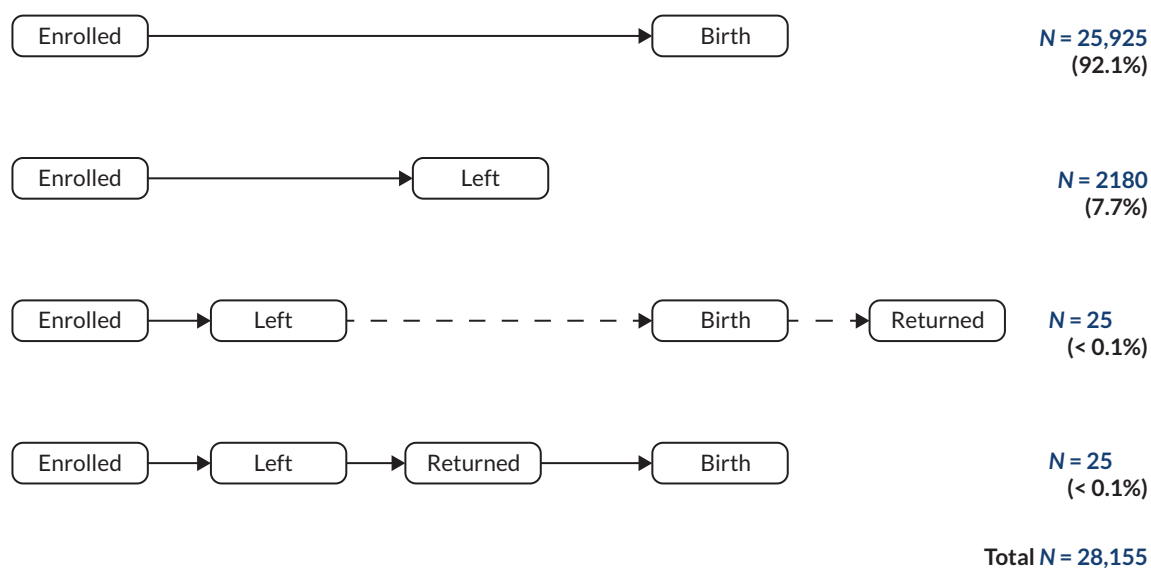
numbers of other errors included leaving and returning dates which were after the completion dates ( $N = 320$ ), leaving and returning dates on the same day, or duplicated dates.

Nine thousand one hundred and twenty (32.4%) FNP participants had no completion dates, and their leaving dates were more than 1 month after their final visit date, suggesting inactivity. For the 3985 of these with no leaving reason, we updated their leaving date to be 1 month after their final visit. This was to account for the opportunity for FNP nurses to attempt to contact the mother before they dropped out of the programme. For the 5135 with a leaving reason, we updated their leaving date to be 2 weeks after their final visit. This was to account for the fact that if the nurses know why the mother left, they are less likely to attempt to schedule further visits.

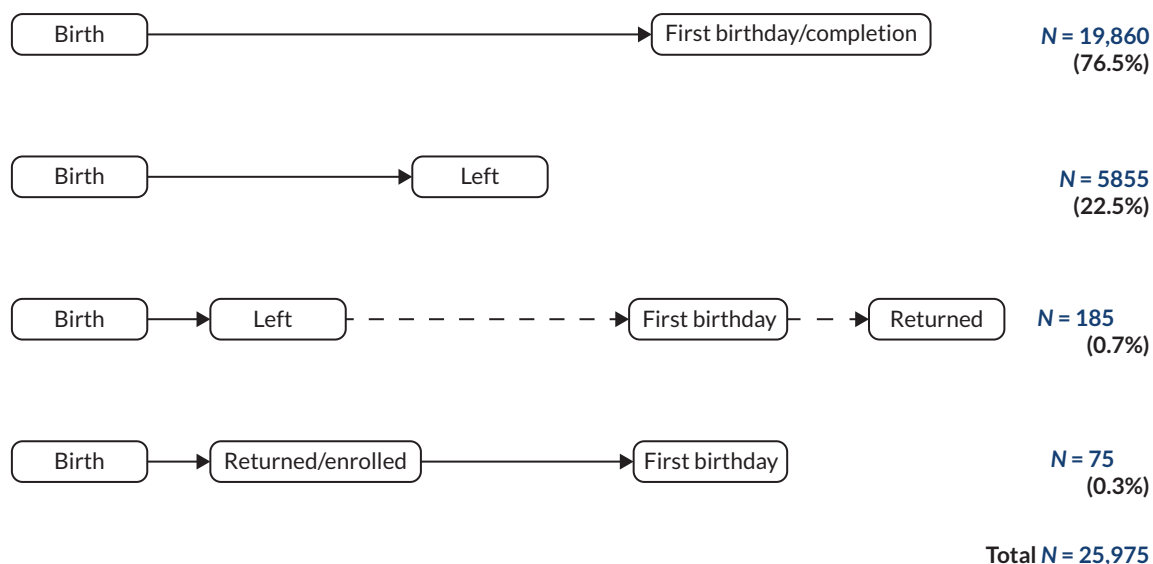
After cleaning, 12,035 (42.7%) of those enrolled in the FNP had a leaving date, and only 300 (1.1%) had a returning date.



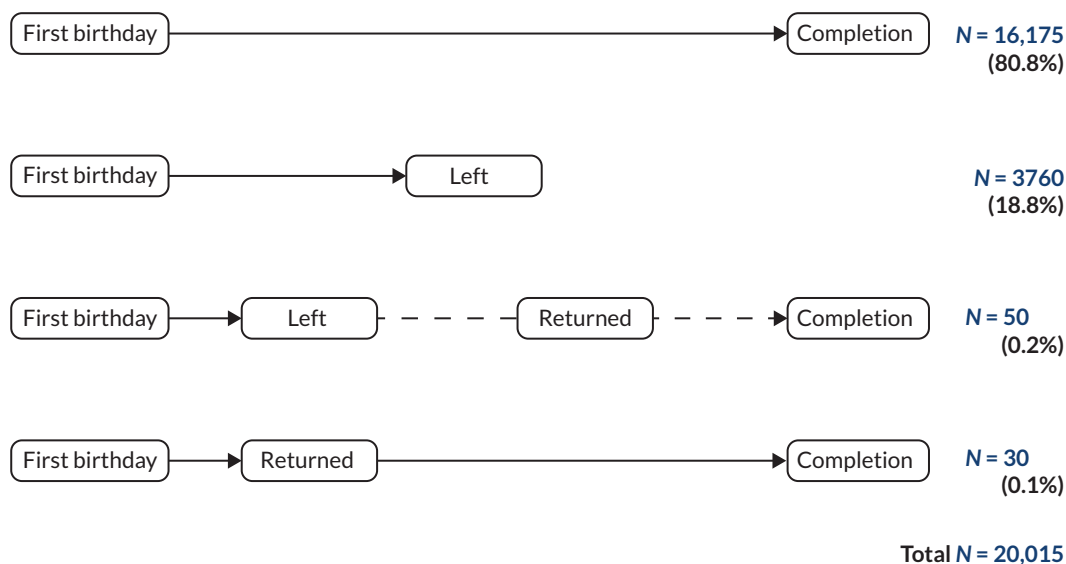
**FIGURE 20** Flow of participants through the full FNP programme, from enrolment to completion.



**FIGURE 21** Flow of participants through the pregnancy stage of the programme.



**FIGURE 22** Flow of participants through the infancy stage of the programme.



**FIGURE 23** Flow of participants through the toddlerhood stage of the programme.





## Appendix 5 Additional information on results for Objective 1: enrolment in the Family Nurse Partnership

**TABLE 32** Numbers of mothers enrolled in each FNP site, for first-time mothers aged 13–19 at LMP by FNP site – births between April 2010 and March 2017

FNP site name	LA(s)	Start date	End date	N enrolled	N eligible	% enrolled	Median monthly caseload	Maximum monthly caseload
<b>Total</b>	-	-	-	<b>25,675</b>	<b>110,520</b>	<b>23.2</b>	-	-
North East								
Durham and Darlington	County Durham, Darlington	August 2009	October 2015	560	3065	18.3	143	212
Gateshead	Gateshead	February 2010	March 2019	185	885	20.9	56	71
Hartlepool	Hartlepool, Stockton-on-Tees	February 2012	April 2017 December 2017	225	985	22.8	80	111
Middlesbrough	Middlesbrough, Redcar and Cleveland	March 2012	April 2015 March 2018	180	960	18.8	51	107
Newcastle upon Tyne	Newcastle upon Tyne	April 2014	September 2016	90	380	23.7	60	79
North Tyneside	North Tyneside	March 2014	March 2016	90	195	46.2	56	75
Northumberland	Northumberland	March 2014	September 2016	90	360	25	58	76
South Tyneside	South Tyneside	January 2010	January 2018	215	815	26.4	60	86
Sunderland	Sunderland	August 2009	March 2019	315	1615	19.5	94	122
North West								
Blackburn with Darwen	Blackburn with Darwen	May 2015	April 2016	55	100	55	34	57
Blackpool	Blackpool	August 2009	March 2019	245	1045	23.4	68	133
Bolton	Bolton	November 2011	March 2019	240	880	27.3	94	123
Bury	Bury	December 2014	March 2019	80	160	50	54	73
Cheshire East	Cheshire East	September 2012	March 2019	210	530	39.6	94	114
Cheshire West	Cheshire West and Chester	February 2012	March 2019	215	675	31.9	75	123

continued

**TABLE 32** Numbers of mothers enrolled in each FNP site, for first-time mothers aged 13–19 at LMP by FNP site – births between April 2010 and March 2017 (*continued*)

FNP site name	LA(s)	Start date	End date	N enrolled	N eligible	% enrolled	Median monthly caseload	Maximum monthly caseload
Cumbria	Allerdale, Barrow-in-Furness, Carlisle, Copeland, Eden, South Lakeland	August 2009	August 2016	205	1875	10.9	53	86
Halton	Halton	July 2014	March 2019	90	220	40.9	64	87
Knowsley	Knowsley	August 2009	March 2019	255	740	34.5	62	95
Lancashire	Burnley, Preston,	April 2015	April 2017	105	215	48.8	80	100
Liverpool	Liverpool	August 2009	March 2019	430	1965	21.9	116	149
Manchester	Manchester	August 2009	September 2016	530	2540	20.9	146	192
Oldham	Oldham	August 2014	March 2019	95	310	30.6	61	88
Rochdale	Rochdale	August 2014	February 2017	95	275	34.5	52	84
Salford	Salford	December 2014	March 2019	85	250	34	63	78
Sefton	Sefton	December 2014	September 2016	45	170	26.5	24	37
St Helens	St Helens	December 2014	March 2019	105	200	52.5	44	89
Stockport	Stockport	August 2014	March 2019	100	185	54.1	52	88
Tameside	Tameside	March 2015	March 2019	70	195	35.9	62	79
Trafford	Trafford	January 2015	March 2017	20	65	30.8	26	30
Warrington	Warrington	April 2015	March 2019	75	145	51.7	69	79
Wigan	Wigan	December 2011	March 2019	205	895	22.9	79	116
Wirral	Wirral	August 2009	March 2019	345	1335	25.8	103	125
Yorkshire and Humber								
Barnsley	Barnsley	August 2009	November 2015	275	970	28.4	89	107
Bradford and Airedale	Bradford	February 2010	March 2019	430	2415	17.8	110	183
Calderdale	Calderdale	August 2009	February 2016	155	935	16.6	51	84
Doncaster	Doncaster	August 2009	March 2016	285	1850	15.4	73	128
East Riding	East Riding of Yorkshire	June 2013	March 2019	60	400	15	33	60

**TABLE 32** Numbers of mothers enrolled in each FNP site, for first-time mothers aged 13–19 at LMP by FNP site – births between April 2010 and March 2017 (*continued*)

FNP site name	LA(s)	Start date	End date	N enrolled	N eligible	% enrolled	Median monthly caseload	Maximum monthly caseload
Hull	Kingston upon Hull, city of	August 2009	June 2017	345	2060	16.7	103	127
Kirklees	Kirklees	August 2009	March 2019	345	1950	17.7	80	138
Leeds	Leeds	August 2009	April 2016	400	3360	11.9	127	171
North and North East Lincolnshire	North East Lincolnshire, North Lincolnshire	March 2012	April 2017	175	1130	15.5	69	88
North Yorkshire	Scarborough	June 2013	December 2014	40	110	36.4	16	35
Rotherham	Rotherham	November 2011	December 2016	200	920	21.7	69	93
Sheffield	Sheffield	August 2009	February 2016	380	2135	17.8	95	191
Wakefield	Wakefield	November 2011	March 2019	290	1235	23.5	106	147
East Midlands								
Derby City	Derby	August 2009	March 2019	415	1350	30.7	106	185
Derbyshire	Amber Valley, Bolsover, Chesterfield, Derbyshire Dales, Erewash, High Peak, North East Derbyshire, South Derbyshire	October 2011	March 2019	355	1775	20	95	166
Leicester City	Leicester	September 2011	May 2017	210	970	21.6	71	95
Lincolnshire	Boston, East Lindsey	August 2014	February 2016	65	200	32.5	47	58
Northamptonshire	Corby, Daventry, East Northamptonshire, Kettering, Northampton, South Northamptonshire, Wellingborough	August 2009	March 2019	375	3000	12.5	96	129
Nottingham City	Nottingham	August 2009	March 2019	435	1815	24	124	179
Nottinghamshire	Ashfield, Bassetlaw, Broxtowe, Gedling, Mansfield, Newark and Sherwood, Rushcliffe	October 2012	March 2019	370	1500	24.7	170	294

continued

**TABLE 32** Numbers of mothers enrolled in each FNP site, for first-time mothers aged 13–19 at LMP by FNP site – births between April 2010 and March 2017 (*continued*)

FNP site name	LA(s)	Start date	End date	N enrolled	N eligible	% enrolled	Median monthly caseload	Maximum monthly caseload
West Midlands								
Birmingham	Birmingham	January 2013	May 2016	450	2235	20.1	89	238
Coventry	Coventry	August 2009	March 2019	290	1610	18	87	115
Dudley	Dudley	February 2013	March 2019	240	645	37.2	108	139
East Staffordshire	East Staffordshire	March 2013	April 2017	85	210	40.5	30	44
Sandwell	Sandwell	August 2009	January 2017	395	2020	19.6	84	167
Shropshire	Shropshire	November 2014	March 2019	95	175	54.3	69	106
Solihull	Birmingham, Solihull	August 2009	March 2019	290	855	33.9	80	115
Staffordshire – Cannock and Tamworth	Cannock Chase, Tamworth	March 2013	August 2016	155	380	40.8	74	106
Stoke-on-Trent	Newcastle-under-Lyme, Stoke-on-Trent	August 2009	October 2016	325	2155	15.1	109	170
Telford and Wrekin	Telford and Wrekin	August 2009	March 2019	215	975	22.1	54	76
Walsall	Walsall	August 2009	September 2016	340	1835	18.5	100	126
Warwickshire North	North Warwickshire, Nuneaton and Bedworth	November 2010	March 2019	200	765	26.1	49	94
Warwickshire South and Rugby	Rugby, Stratford-on-Avon, Warwick	November 2010	March 2019	175	790	22.2	58	82
Wolverhampton	Wolverhampton	November 2014	July 2017	90	295	30.5	63	82
Worcestershire	Bromsgrove, Malvern Hills, Redditch, Worcester, Wychavon, Wyre Forest	September 2015	April 2018	95	315	30.2	60	91
East of England								
Bedford and Bedfordshire	Bedford, Central Bedfordshire	January 2015	January 2017	90	265	34	44	81

TABLE 32 Numbers of mothers enrolled in each FNP site, for first-time mothers aged 13–19 at LMP by FNP site – births between April 2010 and March 2017 (continued)

FNP site name	LA(s)	Start date	End date	N enrolled	N eligible	% enrolled	Median monthly caseload	Maximum monthly caseload
Hertfordshire	Broxbourne, Dacorum, East Hertfordshire, Hertsmere, North Hertfordshire, St Albans, Stevenage, Three Rivers, Watford, Welwyn Hatfield	September 2011	February 2016	215	1455	14.8	74	104
Luton	Luton	September 2015	August 2017	60	140	42.9	38	63
Norfolk	Breckland, Broaland, Great Yarmouth, King's Lynn and West Norfolk, North Norfolk, Norwich, South Norfolk	January 2010	March 2019	545	3140	17.4	155	210
North Essex	Braintree, Colchester, Harlow, Tendring	November 2014	November 2016	135	430	31.4	72	103
Peterborough and Cambridgeshire	Cambridge, East Cambridgeshire, Fenland, Huntingdonshire, Peterborough, South Cambridgeshire	January 2010 December 2011	March 2019	440	2375	18.5	142	182
South-East Essex	Basildon, Castle Point, Rochford, Thurrock	August 2009 February 2015	October 2016 February 2017	145	585	24.8	27	65
Southend	Southend-on-Sea	August 2009	March 2019	170	625	27.2	45	67
Suffolk	Ipswich, Suffolk Coastal, Waveney	October 2010 August 2013	March 2018 May 2018 March 2019	285	870	32.8	91	133
London								
Barking and Dagenham	Barking and Dagenham	November 2010	November 2015	185	655	28.2	45	71
Barnet	Barnet	November 2011	March 2019	175	360	48.6	60	80
Brent	Brent	June 2014	July 2016	75	270	27.8	38	49
Bromley and Bexley	Bexley, Bromley	September 2014 October 2014	August 2016 March 2019	90	270	33.3	49	61

continued

**TABLE 32** Numbers of mothers enrolled in each FNP site, for first-time mothers aged 13–19 at LMP by FNP site – births between April 2010 and March 2017 (*continued*)

FNP site name	LA(s)	Start date	End date	N enrolled	N eligible	% enrolled	Median monthly caseload	Maximum monthly caseload
Camden	Camden	January 2015	July 2018	30	55	54.5	10	19
Croydon	Croydon	October 2010	March 2019	200	1010	19.8	69	97
Ealing	Ealing	August 2009	March 2019	220	720	30.6	55	70
Enfield	Enfield	November 2013	March 2019	110	385	28.6	46	78
Greenwich	Greenwich	April 2014	March 2019	110	360	30.6	70	86
Hackney	Hackney	May 2014	March 2019	85	300	28.3	41	54
Haringey	Haringey	July 2010	March 2019	200	725	27.6	58	91
Hounslow	Hounslow	July 2011	March 2019	155	435	35.6	53	76
Islington	Islington	August 2009	March 2019	175	470	37.2	34	63
Lambeth	Lambeth	August 2009	March 2019	270	950	28.4	72	107
Lewisham	Lewisham	January 2010	March 2019	280	950	29.5	84	105
Merton	Merton	September 2013	March 2019	45	135	33.3	25	33
Newham	Newham	September 2013	March 2019	90	425	21.2	47	68
Southwark	Southwark	August 2009	March 2019	270	840	32.1	73	86
Sutton	Sutton	January 2014	June 2017	60	160	37.5	25	45
Tower Hamlets	Tower Hamlets	August 2009	March 2019	275	645	42.6	79	109
Waltham Forest and Redbridge	Redbridge, Waltham Forest	August 2009 October 2013	March 2019	220	1085	20.3	48	73
Wandsworth	Wandsworth	May 2015	March 2019	65	95	68.4	49	73
West Central London	Hammersmith and Fulham, Kensington and Chelsea, Westminster	February 2010	March 2019	220	725	30.3	47	70
South East								
Berkshire East	Bracknell Forest, Slough, Windsor and Maidenhead	August 2009	February 2016	335	855	39.2	96	114

TABLE 32 Numbers of mothers enrolled in each FNP site, for first-time mothers aged 13–19 at LMP by FNP site – births between April 2010 and March 2017 (continued)

FNP site name	LA(s)	Start date	End date	N enrolled	N eligible	% enrolled	Median monthly caseload	Maximum monthly caseload
Berkshire West	Reading, West Berkshire, Wokingham	November 2012	June 2016	170	610	27.9	66	84
Brighton and Hove	Brighton and Hove	October 2012	March 2016	125	270	46.3	52	89
Buckinghamshire	Aylesbury Vale, Chiltern, South Buckinghamshire, Wycombe	July 2012	March 2019	225	620	36.3	93	128
East Sussex – East	Hastings, Rother	August 2009	November 2015 December 2015	245	795	30.8	72	107
East Sussex – West	Eastbourne, Lewes, Wealden	November 2010 March 2011 December 2011	June 2015 November 2015 December 2015	250	620	40.3	95	118
Hampshire	Basingstoke and Deane, Fareham, Gosport, Hart, Havant, Rushmoor	March 2015 April 2015 August 2015 January 2016	April 2017 March 2018 August 2018 March 2019	190	360	52.8	145	179
Kent North	Gravesham, Swale, Thanet	February 2012 December 2014	March 2017 June 2018	215	1045	20.6	83	101
Kent South	Dover, Maidstone, Shepway, Tonbridge and Malling	February 2013 December 2014	October 2017 June 2018	170	660	25.8	58	101
Medway	Medway	August 2009	December 2015	265	1280	20.7	75	118
Milton Keynes	Milton Keynes	August 2009	October 2016	165	995	16.6	42	67
Oxfordshire	Cherwell, Oxford, South Oxfordshire, Vale of White Horse, West Oxfordshire	February 2010	March 2019	475	1730	27.5	131	180
Portsmouth	Portsmouth	November 2011	March 2019	290	665	43.6	111	155
Southampton	Southampton	August 2009	March 2019	225	1200	18.8	81	98

continued



**TABLE 32** Numbers of mothers enrolled in each FNP site, for first-time mothers aged 13–19 at LMP by FNP site – births between April 2010 and March 2017 (*continued*)

FNP site name	LA(s)	Start date	End date	N enrolled	N eligible	% enrolled	Median monthly caseload	Maximum monthly caseload
Surrey	Elmbridge, Epsom and Ewell, Guildford, Mole Valley, Reigate and Banstead, Runnymede, Spelthorne, Surrey Heath, Tandridge, Waverley, Woking	November 2014	March 2019	110	420	26.2	58	83
West Sussex	Adur, Arun, Chichester, Crawley, Horsham, Mid Sussex, Worthing,	September 2011	March 2019	265	1490	17.8	101	118
South West								
Bath and North East Somerset	Bath and North East Somerset	February 2013	March 2019	100	175	57.1	51	67
Bristol and South Gloucestershire	Bristol, city of, South Gloucestershire	May 2014	March 2019	150	560	26.8	91	124
Bristol and North Somerset	North Somerset	August 2014	August 2015	30	80	37.5	20	27
Cornwall and Isles of Scilly	Cornwall	August 2009	November 2017	470	2105	22.3	130	167
Plymouth	Plymouth	August 2009	March 2019	225	1310	17.2	61	99
Swindon	Swindon	August 2009	March 2019	340	920	37	96	132
Wiltshire	Wiltshire	November 2014	March 2019	85	285	29.8	51	65

**TABLE 33** Characteristics of mothers aged 13–19 at LMP, ever enrolled in the FNP (information from the FNP IS)

	All mothers enrolled in FNP		Mothers aged 13–19		Mothers aged 20–24	
	N	%	N	%	N	%
<b>Total</b>	<b>31,425</b>		<b>31,260</b>		<b>165</b>	
Living arrangements at enrolment						
Alone	1810	5.8	1785	5.7	25	15.3
Foster carers/group home/other	2845	9.1	2825	9.0	20	12.9
Mother (with or without partner)	16,750	53.3	16,710	53.4	45	27.0
Partner (with or without others, not mother)	6035	19.2	5990	19.2	50	29.4
Relatives/other adults	3080	9.8	3055	9.8	20	12.9
Missing	905	2.9	–	–	–	–

**TABLE 33** Characteristics of mothers aged 13–19 at LMP, ever enrolled in the FNP (information from the FNP IS)  
(continued)

	All mothers enrolled in FNP		Mothers aged 13–19		Mothers aged 20–24	
	N	%	N	%	N	%
Relationship status at enrolment						
In a relationship with biological father	22,310	71.0	22,215	71.1	100	60.1
In a relationship with other partner	990	3.1	-	-	-	-
Single	7220	23.0	7165	22.9	55	33.7
Missing	905	2.9	-	-	-	-
Care leaver during pregnancy	1155	3.7	1140	3.6	15	8.0
CiN, CPP or CLA during pregnancy	4725	15.0	4710	15.1	15	9.2
Alcohol or drug use in 2 weeks before enrolment	1500	4.8	-	-	-	-

**Note**

Numbers have been rounded to the nearest 5 and cell sizes < 10 have been suppressed, in accordance with NHS Digital's and DfE's statistical disclosure rules for subnational analyses.

**TABLE 34** Characteristics of mothers aged 13–19 ever enrolled and never enrolled in the FNP (information from HES and NPD)

	All mothers		Mothers enrolled in FNP		Mothers never enrolled in FNP	
	N	%	N	%	N	%
<b>Total</b>	<b>130,415</b>	<b>100</b>	<b>31,260</b>	<b>100</b>	<b>99,150</b>	<b>100</b>
Maternal age at delivery (years)						
13–15	2685	2.1	1450	4.6	1235	1.2
16–17	26,065	20.0	10,370	33.2	15,690	15.8
18–19	72,465	55.6	15,805	50.6	56,660	57.1
20 <sup>a</sup>	29,205	22.4	3635	11.6	25565	25.8
Ethnicity						
White	109,820	84.2	26,330	84.2	83,485	84.2
South Asian	3695	2.8	670	2.1	3030	3.1
Black	4650	3.6	1470	4.7	3180	3.2
Mixed/other	6840	5.2	1685	5.4	5155	5.2
Unknown	5410	4.1	1110	3.5	4300	4.3
Area-level deprivation (quintile of IMD)						
Least deprived	6810	5.2	1445	4.6	5360	5.4
2	10,410	8.0	2305	7.4	8105	8.2
3	17,855	13.7	4115	13.2	13,735	13.9
4	32,550	25	7890	25.2	24,660	24.9

continued

**TABLE 34** Characteristics of mothers aged 13–19 ever enrolled and never enrolled in the FNP (information from HES and NPD) (continued)

	All mothers		Mothers enrolled in FNP		Mothers never enrolled in FNP	
	N	%	N	%	N	%
Most deprived	62,630	48	15,340	49.1	47,290	47.7
Unknown	160	0.1	–	–	–	–
Region						
North East	10,195	7.8	2160	6.9	8035	8.1
North West	18,820	14.4	5035	16.1	13,785	13.9
Yorkshire and Humber	21,045	16.1	3730	11.9	17,315	17.5
East Midlands	13,000	10.0	2815	9.0	10,185	10.3
West Midlands	17,160	13.2	3905	12.5	13,255	13.4
East of England	11,710	9.0	2565	8.2	9150	9.2
London	15,300	11.7	4740	15.2	10,560	10.7
South East	16,365	12.5	4510	14.4	11,855	12.0
South West	6820	5.2	1805	5.8	5015	5.1
Year of delivery						
2010	10,030	7.7	2045	6.5	7985	8.1
2011	13,620	10.4	1860	6.0	11,760	11.9
2012	15,820	12.1	2865	9.2	12,960	13.1
2013	16,810	12.9	4070	13.0	12,735	12.8
2014	16,225	12.4	3590	11.5	12,635	12.7
2015	17,955	13.8	5110	16.3	12,845	13.0
2016	16,745	12.8	5260	16.8	11,485	11.6
2017	12,135	9.3	3145	10.1	8985	9.1
2018	9185	7.0	2660	8.5	6525	6.6
2019	1890	1.4	650	2.1	1240	1.2
History of admissions/attendances with diagnoses within 2 years prior to 20 weeks of pregnancy						
Adversity (violence, self harm, substance misuse)	5475	4.2	2295	7.3	3185	3.2
Violence	475	0.4	200	0.6	280	0.3
Self-harm	4055	3.1	1755	5.6	2305	2.3
Substance misuse	4960	3.8	2065	6.6	2895	2.9
Mental health (exc. self-harm/substance misuse)	3340	2.6	1400	4.5	1935	2.0
Mental health (inc. self-harm/substance misuse)	6550	5.0	2690	8.6	3860	3.9
Chronic condition (any, exc. mental health)	11,565	8.9	3770	12.1	7800	7.9
A&E attendances	82,320	63.1	21,985	70.3	60,335	60.8

**TABLE 34** Characteristics of mothers aged 13–19 ever enrolled and never enrolled in the FNP (information from HES and NPD) (continued)

	All mothers		Mothers enrolled in FNP		Mothers never enrolled in FNP	
	N	%	N	%	N	%
Repeat A&E attendances ( $\geq 4$ )	21,105	16.2	6860	21.9	14,245	14.4
Did not attend at least one outpatient appointment	37,575	32.7	11,030	38.3	26,545	30.9
Gestational age at antenatal booking appointment						
Before 10 weeks	35,280	27.1	8390	26.8	26,890	27.1
10–20 weeks	47,985	36.8	11,530	36.9	36,455	36.8
20 weeks or more	7315	5.6	1925	6.2	5395	5.4
Unknown	39,830	30.5	9420	30.1	30,415	30.7
Total linked to NPD (social care and education risk factors before 20 weeks of pregnancy available)	109,360	83.9	28,145	90.0	81,210	81.9
Ever excluded, in PRU or alternative provision	32,945	25.3	10,560	33.8	22,390	22.6
Ever recorded as persistently absent in a term	40,600	31.1	15,090	48.3	25,510	25.7
Ever in care	6955	5.3	3235	10.3	3720	3.8
Ever had recorded CPP	3885	3.0	1990	6.4	1895	1.9
Educational attainment (GCSEs) <sup>b</sup>	100,270	76.9	23,785	76.1	76,485	77.1
Achieved 5 A*–C GCSEs inc. Eng/ Maths	19,920	18.4	3975	14.2	15,945	19.8
Total linked to Key Stage 2 data	104,375	80.0	27,010	86.4	77,360	78.0
Achieved expected level at Key Stage 2 (Maths)	56,930	43.7	14,175	45.3	42,755	43.1
Achieved expected level at Key Stage 2 (English)	69,610	53.4	17,525	56.1	52,090	52.5
Total linked to NPD Census (FSM, SEN and IDACI available)	108,365	83.1	27,995	89.6	80,365	81.1
Ever recorded as having SEN provision	56,475	43.3	17,150	54.9	39,325	39.7
Ever recorded as having FSM	61,315	47.0	18,525	59.3	42,795	43.2
Ever in bottom IDACI decile	39,090	30.0	11,565	37.0	27,525	27.8

a includes only mothers aged 19 at last menstrual period.

b Of those eligible to have taken GCSEs before 20 weeks of pregnancy.

**TABLE 35** Characteristics of mothers aged 20–24 ever enrolled and never enrolled in the FNP (information from HES and NPD)

	All mothers		Mothers enrolled in FNP		Mothers never enrolled in FNP	
	N	%	N	%	N	%
<b>Total</b>	<b>4465</b>	<b>100</b>	<b>165</b>	<b>100</b>	<b>4305</b>	<b>100</b>
Maternal age at delivery (years)						
20–21	1095	24.5	80	48.5	1015	23.6
22–25	3375	75.5	85	51.5	3290	76.4
Ethnicity						
White	2460	55.1	85	53.4	2375	55.1
South Asian	510	11.4	15	8.0	495	11.5
Black	395	8.8	25	16.0	370	8.6
Mixed/other	405	9.1	20	12.3	385	8.9
Unknown	695	15.6	15	10.4	680	15.8
Year of delivery						
2016	–	–	–	–	–	–
2017	1435	32.1	50	30.3	1385	32.2
2018	2465	55.2	85	51.5	2380	55.3
2019	565	12.7	25	15.2	540	12.5
History of admissions/attendances with diagnoses within 2 years prior to 20 weeks of pregnancy						
Adversity	60	1.4	10	7.4	50	1.2
Violence	10	0.2	–	–	–	–
Self-harm	40	0.9	10	4.9	35	0.8
Substance misuse	55	1.3	10	7.4	45	1.0
Mental health (exc. self-harm/substance misuse)	85	1.9	10	7.4	75	1.7
Mental health (inc. self-harm/substance misuse)	110	2.5	15	9.2	95	2.2
Chronic condition (any, exc. mental health)	400	8.9	35	21.5	360	8.4
Repeat A&E attendances (≥ 4)	595	13.3	45	28.8	550	12.8
A&E attendances	2465	55.1	130	80.4	2330	54.2
Did not attend at least one outpatient appointment	1185	32.2	75	51.8	1110	31.4
Gestational age at antenatal booking appointment						
Before 10 weeks	815	18.3	30	18.4	785	18.3
10–20 weeks	1240	27.7	50	31.9	1185	27.6
20 weeks or more	165	3.7	10	6.1	155	3.6
Unknown	2245	50.3	70	43.6	2175	50.6
Total linked to NPD (social care and education risk factors before 20 weeks of pregnancy available)	2655	59.5	115	69.7	2545	59.1

**TABLE 35** Characteristics of mothers aged 20–24 ever enrolled and never enrolled in the FNP (information from HES and NPD) (continued)

	All mothers		Mothers enrolled in FNP		Mothers never enrolled in FNP	
	N	%	N	%	N	%
Ever excluded, in PRU or alternative provision	505	11.3	40	24.2	465	10.8
Ever in care	85	1.9	25	15.2	60	1.4
Total linked to NPD Census (FSM, SEN and IDACI available)	2605	58.3	110	67.5	2500	58.1
Ever recorded as having SEN provision	1180	26.4	85	51.5	1095	25.4
Ever recorded as having FSM	1240	27.8	90	54.5	1150	26.7
Ever in bottom IDACI decile	900	20.2	50	30.3	850	19.7
Educational attainment (GCSEs) <sup>a</sup>	2660	59.5	115	69.9	2545	59.1
5 A*–C GCSEs inc. Eng/Maths	920	34.5	20	19.3	895	35.2
Did not achieve 5 A*–C GCSEs inc. Eng/Maths	1740	65.5	90	80.7	1650	64.8
Linked to Key Stage 2 data	2465	55.2	105	63.6	2365	54.9
Achieved expected level at Key Stage 2 (Maths)	1535	34.4	45	27.3	1490	34.6
Achieved expected level at Key Stage 2 (English)	1805	40.4	55	33.3	1750	40.7

<sup>a</sup> Among mothers who were aged  $\geq 16$  at the start of the academic year in which they reached 20 weeks of pregnancy.

**Note**

Numbers have been rounded to the nearest 5 and cell sizes  $< 10$  have been suppressed, in accordance with NHS Digital's and DfE's statistical disclosure rules for subnational analyses.

**TABLE 36** Comparison of maternal risk factors among eligible mothers aged 13–19 living in an area with an active FNP site at the time of first antenatal appointment and those living in an area where FNP was never commissioned, births between March 2010 and April 2017

	N (%) eligible mothers	N enrolled in FNP	% eligible who were enrolled	N (%) mothers in LAs where FNP was never commissioned
<b>Total</b>	<b>110,520</b>	<b>25,675</b>	<b>23.2</b>	<b>100,455</b>
Maternal age at birth				
13–15	2380 (2.2)	1240	52.1	2160 (2.2)
16–17	22,725 (20.6)	8720	38.4	20,040 (19.9)
18–19	61,090 (55.3)	12,875	21.1	56,310 (56.1)
20	24,325 (22.0)	2840	11.7	21,945 (21.8)
Ethnicity				
White	93,730 (84.8)	21,845	23.3	88,895 (88.5)
South Asian	3170 (2.9)	535	16.9	2325 (2.3)
Black	3970 (3.6)	1195	30.1	2705 (2.7)
Mixed/other	5695 (5.2)	1335	23.4	3905 (3.9)
Unknown	3950 (3.6)	770	19.5	2620 (2.6)

continued

**TABLE 36** Comparison of maternal risk factors among eligible mothers aged 13–19 living in an area with an active FNP site at the time of first antenatal appointment and those living in an area where FNP was never commissioned, births between March 2010 and April 2017 (continued)

	N (%) eligible mothers	N enrolled in FNP	% eligible who were enrolled	N (%) mothers in LAs where FNP was never commissioned
IMD (quintile)				
Least deprived	5550 (5.0)	1135	20.5	8460 (8.4)
2	8565 (7.7)	1820	21.2	12,825 (12.8)
3	14,835 (13.4)	3330	22.4	18,065 (18.0)
4	27,520 (24.9)	6430	23.4	25,630 (25.5)
Most deprived	53,905 (48.8)	12,820	23.8	34,890 (34.7)
Unknown	145 (0.1)	145	100	580 (0.6)
Admission with diagnoses within 2 years before 20 weeks pregnancy				
Mental health (excluding substance misuse and self-harm)	2420 (2.2)	955	39.5	1950 (1.9)
Adversity-related (self-harm, substance misuse, violence)	4460 (4.0)	1770	39.7	3910 (3.9)
Any chronic condition	9580 (8.7)	3170	33.1	8105 (8.1)
A&E attendance	68,965 (62.4)	17,815	25.8	61,255 (61.0)
Gestational age at antenatal booking appointment				
Before 10 weeks	29,390 (26.6)	6810	23.2	25,840 (25.7)
10–20 weeks	40,640 (36.8)	9540	23.5	36,325 (36.2)
20 weeks or more	6095 (5.5)	1515	24.9	10,180 (10.1)
Unknown	34,390 (31.1)	7815	22.7	28,105 (28.0)
Linkage with education/social care data in the NPD				
Linked to NPD	92,260 (83.5)	22,980	24.9	84,385 (84.0)
Not linked to NPD	17,405 (15.7)	2570	14.8	14,970 (14.9)
Linked to NPD but not to NPD census	855 (0.8)	125	14.6	1100 (1.1)
Ever had a CPP or was Looked After before 20 weeks of pregnancy <sup>a</sup>				
No CPP or Looked After	85,890 (77.7)	19,860	23.1	79,965 (79.6)
CPP, but not Looked After	1685 (1.5)	800	47.5	14,970 (14.9)
Looked after (and CPP)	5540 (5.0)	2445	44.1	4690 (4.7)
Education risk factors before 20 weeks of pregnancy				
Ever recorded as having SEN provision <sup>a</sup>	46,990 (42.5)	13,790	29.3	36,645 (36.5)
Ever recorded as receiving FSM <sup>a</sup>	50,805 (46.0)	14,930	29.4	36,820 (36.7)

**TABLE 36** Comparison of maternal risk factors among eligible mothers aged 13–19 living in an area with an active FNP site at the time of first antenatal appointment and those living in an area where FNP was never commissioned, births between March 2010 and April 2017 (continued)

	N (%) eligible mothers	N enrolled in FNP	% eligible who were enrolled	N (%) mothers in LAs where FNP was never commissioned
Ever in IDACI bottom decile <sup>a</sup>	32,495 (29.4)	9220	28.4	19,280 (19.2)
Did not achieve 5 A*-C GCSEs <sup>b</sup>	69,345 (62.7)	16,365	23.6	64,420 (64.1)
Ever excluded, in PRU, or alternative provision <sup>a</sup>	28,105 (25.2)	8620	30.7	24,485 (24.4)
Ever persistently absent in a term (≥ 10% possible sessions) <sup>a</sup>	35,535 (32.2)	12,725	35.8	32,275 (32.1)

a Of those with available data in the NPD.

b Among mothers who were aged ≥ 16 at the start of the academic year in which they reached 20 weeks of pregnancy.

**Note**

Numbers have been rounded to the nearest 5 and cell sizes < 10 have been suppressed, in accordance with NHS Digital's and DfE's statistical disclosure rules for subnational analyses.

**TABLE 37** Distribution of FNP sites, first-time adolescent mothers enrolled in FNP, eligible mothers and median and maximum caseloads by quartile of enrolment rates, births between March 2010 and April 2017

Percentage of eligible mothers enrolled (quartiles)	N FNP sites	N mothers enrolled in FNP	N eligible mothers	Median monthly caseload	Median maximum monthly caseload
Low-enrolment sites (≤ 21%)	30	9610	56,020	87	126
21–28%	30	6840	28,470	67	95
28–36%	30	5170	16,530	61	86
High-enrolment sites (36–67%)	30	4070	9500	58	84

**Note**

Numbers have been rounded to the nearest 5 and cell sizes < 10 have been suppressed, in accordance with NHS Digital's and DfE's statistical disclosure rules for subnational analyses. The total number of FNP sites is 122 (120 in the table above due to rounding).

**TABLE 38** Risk factors for enrolment in the FNP in high- and low-enrolment sites, among mothers aged 13–19 at LMP, living in a LA with an active FNP site at the time of first antenatal appointment – England, births April 2010–March 2017

	High-enrolment sites (≥ 36%)					Low-enrolment sites (≤ 21%)				
	N eligible mothers	N enrolled in FNP	% enrolled in FN	Crude OR (95% CI)	Adjusted <sup>a</sup> OR (95% CI)	N eligible mothers	N enrolled in FNP	% enrolled in FNP	Crude OR (95% CI)	Adjusted <sup>a</sup> OR (95% CI)
<b>Total</b>	9495	4065	42.8	–	–	56,020	9605	17.1	–	–
Maternal age at birth										
13–15	150 (1.6)	105	70	3.62 (2.53 to 5.19)	2.14 (1.39 to 3.29)	1,295 (2.3)	585	45.2	4.66 (4.16 to 5.23)	2.60 (2.25 to 3.01)

continued



**TABLE 38** Risk factors for enrolment in the FNP in high- and low-enrolment sites, among mothers aged 13–19 at LMP, living in a LA with an active FNP site at the time of first antenatal appointment – England, births April 2010–March 2017 (continued)

	High-enrolment sites ( $\geq 36\%$ )					Low-enrolment sites ( $\leq 21\%$ )				
	N eligible mothers	N enrolled in FNP	% enrolled in FN	Crude OR (95% CI)	Adjusted <sup>a</sup> OR (95% CI)	N eligible mothers	N enrolled in FNP	% enrolled in FNP	Crude OR (95% CI)	Adjusted <sup>a</sup> OR (95% CI)
16–17	1785 (18.8)	1145	64.1	2.59 (2.32 to 2.90)	1.92 (1.68 to 2.19)	11,755 (21.0)	3610	30.7	2.52 (2.40 to 2.65)	1.78 (1.67 to 1.89)
18–19	5345 (56.3)	2200	41.2	1 (ref)	1 (ref)	30,650 (54.7)	4610	15	1 (ref)	1 (ref)
20 <sup>b</sup>	2215 (23.3)	615	27.8	0.53 (0.48 to 0.59)	0.61 (0.55 to 0.69)	12,320 (22.0)	800	6.5	0.39 (0.36 to 0.42)	0.47 (0.44 to 0.51)
Ethnicity										
White	7775 (81.9)	3425	44.1	1 (ref)	1 (ref)	48,735 (87.0)	8555	17.6	1 (ref)	1 (ref)
South Asian	500 (5.3)	175	35	0.61 (0.49 to 0.75)	0.78 (0.62 to 0.99)	1,670 (3.0)	160	9.6	0.44 (0.37 to 0.52)	0.63 (0.53 to 0.75)
Black	310 (3.3)	135	43.5	0.98 (0.77 to 1.25)	1.09 (0.84 to 1.42)	1370 (2.4)	290	21.2	1.13 (0.99 to 1.30)	1.31 (1.13 to 1.53)
Mixed/ other	475 (5.0)	190	40	0.82 (0.67 to 0.99)	0.93 (0.75 to 1.14)	2585 (4.6)	400	15.5	0.77 (0.69 to 0.86)	0.85 (0.75 to 0.95)
Unknown	435 (4.6)	140	32.2	0.57 (0.47 to 0.71)	0.72 (0.58 to 0.90)	1660 (3.0)	200	12	0.61 (0.53 to 0.71)	0.78 (0.66 to 0.91)
IMD (quintile)										
Least deprived	745 (7.8)	265	35.6	0.77 (0.64 to 0.93)	0.80 (0.66 to 0.98)	2410 (4.3)	300	12.4	0.79 (0.68 to 0.90)	0.84 (0.73 to 0.97)
2	1040 (11.0)	425	40.9	0.98 (0.84 to 1.16)	1.00 (0.84 to 1.19)	4395 (7.8)	620	14.1	0.89 (0.80 to 0.99)	0.93 (0.83 to 1.03)
3	1540 (16.2)	640	41.6	1 (ref)	1 (ref)	7465 (13.3)	1160	15.5	1 (ref)	1 (ref)
4	2490 (26.2)	1080	43.4	1.10 (0.97 to 1.26)	1.03 (0.90 to 1.18)	13,100 (23.4)	2210	16.9	1.11 (1.02 to 1.20)	1.06 (0.98 to 1.15)
Most deprived	3650 (38.4)	1630	44.7	1.20 (1.05 to 1.36)	1.07 (0.93 to 1.23)	28,625 (51.1)	5295	18.5	1.25 (1.16 to 1.35)	1.12 (1.04 to 1.21)
Unknown	25 (0.3)	25	100	–	–	25 (0.0)	25	100	–	–
Admission with diagnoses within 2 years before 20 weeks of pregnancy										
Mental health (excluding substance misuse and self-harm)	260 (2.7)	160	61.5	2.19 (1.70 to 2.84)	1.22 (0.89 to 1.68)	1170 (2.1)	365	31.2	2.25 (1.98 to 2.55)	1.46 (1.25 to 1.72)
Adversity-related	420 (4.4)	270	64.3	2.55 (2.07 to 3.13)	1.27 (0.96 to 1.68)	2245 (4.0)	705	31.4	2.33 (2.12 to 2.55)	1.20 (1.05 to 1.38)
Any chronic condition	945 (10.0)	540	57.1	1.88 (1.64 to 2.16)	1.30 (1.07 to 1.57)	4700 (8.4)	1195	25.4	1.76 (1.64 to 1.88)	1.14 (1.02 to 1.27)
A&E attendances	6010 (63.3)	2805	46.7	1.55 (1.42 to 1.69)	1.31 (1.19 to 1.44)	33,925 (60.6)	6525	19.2	1.47 (1.40 to 1.54)	1.27 (1.21 to 1.34)

**TABLE 38** Risk factors for enrolment in the FNP in high- and low-enrolment sites, among mothers aged 13–19 at LMP, living in a LA with an active FNP site at the time of first antenatal appointment – England, births April 2010–March 2017 (continued)

	High-enrolment sites (≥ 36%)					Low-enrolment sites (≤ 21%)				
	N eligible mothers	N enrolled in FNP	% enrolled in FN	Crude OR (95% CI)	Adjusted <sup>a</sup> OR (95% CI)	N eligible mothers	N enrolled in FNP	% enrolled in FNP	Crude OR (95% CI)	Adjusted <sup>a</sup> OR (95% CI)
Gestational age at antenatal booking appointment										
Before 10 weeks	2190 (23.1)	950	43.4	1 (ref)	1 (ref)	15,375 (27.4)	2700	17.6	1 (ref)	1 (ref)
10–20 weeks	3745 (39.4)	1650	44.1	1.01 (0.91 to 1.13)	0.99 (0.88 to 1.12)	19,430 (34.7)	3300	17	0.92 (0.87 to 0.98)	0.88 (0.82 to 0.93)
20 weeks or more	830 (8.7)	345	41.6	0.97 (0.82 to 1.16)	0.84 (0.69 to 1.02)	2555 (4.6)	390	15.3	0.79 (0.70 to 0.89)	0.63 (0.55 to 0.71)
Unknown	2730 (28.8)	1120	41	0.89 (0.79 to 1.01)	0.79 (0.69 to 0.91)	18,660 (33.3)	3215	17.2	0.95 (0.89 to 1.02)	0.82 (0.77 to 0.88)
Linked to NPD										
Linked to NPD	7860 (82.8)	3600	45.8	1 (ref)	1 (ref)	47,410 (84.6)	8800	18.6	1 (ref)	1 (ref)
Not linked to NPD	1555 (16.4)	440	28.3	0.44 (0.38 to 0.49)	0.71 (0.60 to 0.84)	8190 (14.6)	765	9.3	0.43 (0.40 to 0.46)	0.88 (0.80 to 0.97)
Linked to NPD but not to NPD census	85 (0.9)	20	23.5	0.38 (0.23 to 0.63)	0.66 (0.39 to 1.10)	420 (0.7)	40	9.5	0.46 (0.33 to 0.63)	0.78 (0.56 to 1.09)
Ever had a CPP or was looked after before 20 weeks of pregnancy										
No CPP or Looked After	7210 (75.9)	3155	43.8	1 (ref)	1 (ref)	44,470 (79.4)	7595	17.1	1 (ref)	1 (ref)
Looked After (CPP)	545 (5.7)	350	64.2	2.28 (1.90 to 2.74)	1.63 (1.33 to 1.98)	2640 (4.7)	970	36.7	2.79 (2.57 to 3.03)	2.07 (1.89 to 2.26)
CPP, but not Looked After	190 (2.0)	120	63.2	2.06 (1.53 to 2.77)	1.08 (0.78 to 1.48)	720 (1.3)	275	38.2	3.04 (2.61 to 3.54)	1.63 (1.38 to 1.92)
Not linked to NPD	1555 (16.4)	440	28.3	0.48 (0.42 to 0.54)	– <sup>c</sup>	8190 (14.6)	765	9.3	0.48 (0.44 to 0.52)	– <sup>c</sup>
Ever recorded as having SEN before 20 weeks of pregnancy										
No	3615 (38.1)	1425	39.4	1 (ref)	1 (ref)	24,000 (42.8)	3570	14.9	1 (ref)	1 (ref)
Yes	4245 (44.7)	2175	51.2	1.60 (1.46 to 1.75)	1.25 (1.13 to 1.39)	23,405 (41.8)	5230	22.3	1.65 (1.57 to 1.73)	1.22 (1.15 to 1.28)
Not linked to NPD	1555 (16.4)	440	28.3	0.56 (0.49 to 0.65)	– <sup>c</sup>	8190 (14.6)	765	9.3	0.56 (0.52 to 0.61)	– <sup>c</sup>

continued

**TABLE 38** Risk factors for enrolment in the FNP in high- and low-enrolment sites, among mothers aged 13–19 at LMP, living in a LA with an active FNP site at the time of first antenatal appointment – England, births April 2010–March 2017 (continued)

	High-enrolment sites (≥ 36%)					Low-enrolment sites (≤ 21%)				
	N eligible mothers	N enrolled in FNP	% enrolled in FN	Crude OR (95% CI)	Adjusted <sup>a</sup> OR (95% CI)	N eligible mothers	N enrolled in FNP	% enrolled in FNP	Crude OR (95% CI)	Adjusted <sup>a</sup> OR (95% CI)
Linked to NPD but not to NPD census	85 (0.9)	20	23.5	0.50 (0.30 to 0.82)	– <sup>c</sup>	420 (0.7)	40	9.5	0.60 (0.43 to 0.82)	– <sup>c</sup>
Ever recorded as receiving FSM before 20 weeks of pregnancy										
No	3370 (35.5)	1330	39.5	1 (ref)	1 (ref)	22,330 (39.9)	3055	13.7	1 (ref)	1 (ref)
Yes	4490 (47.3)	2270	50.6	1.54 (1.40 to 1.69)	1.15 (1.04 to 1.28)	25,080 (44.8)	5740	22.9	1.84 (1.75 to 1.93)	1.24 (1.17 to 1.31)
Not linked to NPD	1555 (16.4)	440	28.3	0.56 (0.49 to 0.65)	– <sup>c</sup>	8190 (14.6)	765	9.3	0.61 (0.56 to 0.67)	– <sup>c</sup>
Linked to NPD but not to NPD census	85 (0.9)	20	23.5	0.49 (0.30 to 0.81)	– <sup>c</sup>	420 (0.7)	40	9.5	0.66 (0.48 to 0.91)	– <sup>c</sup>
Ever in IDACI bottom decile before 20 weeks of pregnancy										
No	5540 (58.3)	2445	44.1	1 (ref)	1 (ref)	31,310 (55.9)	5235	16.7	1 (ref)	1 (ref)
Yes	2320 (24.4)	1160	50	1.22 (1.10 to 1.36)	0.99 (0.88 to 1.11)	16,100 (28.7)	3565	22.1	1.38 (1.31 to 1.45)	1.05 (1.00 to 1.12)
Not linked to NPD	1555 (16.4)	440	28.3	0.47 (0.41 to 0.54)	– <sup>c</sup>	8190 (14.6)	765	9.3	0.49 (0.45 to 0.53)	– <sup>c</sup>
Linked to NPD but not to NPD census	85 (0.9)	20	23.5	0.41 (0.25 to 0.67)	– <sup>c</sup>	420 (0.7)	40	9.5	0.52 (0.38 to 0.72)	– <sup>c</sup>
Educational attainment before 20 weeks of pregnancy										
Did not achieve 5 A*–C GCSEs	5830 (61.4)	2660	45.6	1 (ref)	1 (ref)	35,715 (63.8)	6130	17.2	1 (ref)	1 (ref)
Achieved 5 A*–C GCSEs	1615 (17.0)	595	36.8	0.69 (0.61 to 0.77)	0.92 (0.81 to 1.04)	8470 (15.1)	1150	13.6	0.76 (0.71 to 0.81)	1.06 (0.98 to 1.14)
Not linked to NPD	1555 (16.4)	440	28.3	0.44 (0.39 to 0.50)	– <sup>c</sup>	8190 (14.6)	765	9.3	0.47 (0.44 to 0.51)	– <sup>c</sup>
Had not attempted GCSEs	500 (5.3)	370	74	3.53 (2.86 to 4.35)	1.47 (1.13 to 1.90)	3645 (6.5)	1560	42.8	3.62 (3.37 to 3.89)	1.58 (1.44 to 1.73)

**TABLE 38** Risk factors for enrolment in the FNP in high- and low-enrolment sites, among mothers aged 13–19 at LMP, living in a LA with an active FNP site at the time of first antenatal appointment – England, births April 2010–March 2017 (continued)

	High-enrolment sites (≥ 36%)					Low-enrolment sites (≤ 21%)				
	N eligible mothers	N enrolled in FNP	% enrolled in FN	Crude OR (95% CI)	Adjusted <sup>a</sup> OR (95% CI)	N eligible mothers	N enrolled in FNP	% enrolled in FNP	Crude OR (95% CI)	Adjusted <sup>a</sup> OR (95% CI)
Ever excluded, in PRU, or alternative provision										
No	5460 (57.5)	2320	42.5	1 (ref)	1 (ref)	33,555 (59.9)	5470	16.3	1 (ref)	1 (ref)
Yes	2480 (26.1)	1300	52.4	1.50 (1.36 to 1.65)	1.04 (0.93 to 1.16)	14,275 (25.5)	3370	23.6	1.58 (1.51 to 1.66)	1.03 (0.97 to 1.08)
Not linked to NPD	1555 (16.4)	440	28.3	0.50 (0.44 to 0.57)	– <sup>c</sup>	8190 (14.6)	765	9.3	0.50 (0.46 to 0.55)	– <sup>c</sup>
Ever persistently absent in a term (≥ 10% possible sessions)										
No	5140 (54.1)	1925	37.5	1 (ref)	1 (ref)	29,320 (52.3)	3590	12.2	1 (ref)	1 (ref)
Yes	2805 (29.5)	1700	60.6	2.64 (2.40 to 2.90)	1.47 (1.31 to 1.66)	18,510 (33.0)	5250	28.4	2.87 (2.73 to 3.01)	1.44 (1.36 to 1.53)
Not linked to NPD	1555 (16.4)	440	28.3	0.62 (0.54 to 0.70)	– <sup>c</sup>	8190 (14.6)	765	9.3	0.70 (0.65 to 0.76)	– <sup>c</sup>

a Adjusted models included all variables in the table as covariates.

b Includes only mothers aged 19 at LMP.

c Estimates omitted due to multicollinearity.

#### Note

Numbers have been rounded to the nearest 5 and cell sizes < 10 have been suppressed in accordance with NHS Digital's and DfE's statistical disclosure rules for subnational analyses.

**TABLE 39** Predictors of enrolment in the FNP by English region, among mothers aged 13–19 at LMP, living in a LA with an active FNP site at the time of first antenatal appointment – England, births between April 2010 and March 2017

	North–East					North–West					Yorkshire and the Humber				
	N eligible mothers	N enrolled in FNP	% enrolled in FNP	Crude OR (95% CI)	Adjusted <sup>a</sup> OR (95% CI)	N eligible mothers	N enrolled in FNP	% enrolled in FNP	Crude OR (95% CI)	Adjusted <sup>a</sup> OR (95% CI)	N eligible mothers	N enrolled in FNP	% enrolled in FNP	Crude OR (95% CI)	Adjusted <sup>a</sup> OR (95% CI)
<b>Total</b>	<b>9260</b>	<b>1940</b>	<b>21</b>	<b>–</b>	<b>–</b>	<b>14,970</b>	<b>3895</b>	<b>26</b>	<b>–</b>	<b>–</b>	<b>19,530</b>	<b>3440</b>	<b>17.6</b>	<b>–</b>	<b>–</b>
Maternal age at birth															
13–15	240 (2.6)	130	54.2	5.42 (4.15 to 7.06)	3.03 (2.16 to 4.24)	295 (2.0)	160	54.2	4.13 (3.24 to 5.26)	2.78 (2.07 to 3.74)	475 (2.4)	190	40	3.83 (3.15 to 4.65)	2.29 (1.78 to 2.93)
16–17	2065 (22.3)	710	34.4	2.48 (2.21 to 2.79)	1.91 (1.65 to 2.20)	3050 (20.4)	1300	42.6	2.48 (2.26 to 2.71)	1.83 (1.64 to 2.04)	4110 (21.0)	1305	31.8	2.60 (2.39 to 2.84)	1.88 (1.69 to 2.09)
18–19	5070 (54.8)	895	17.7	1 (ref)	1 (ref)	8365 (55.9)	2015	24.1	1 (ref)	1 (ref)	10,695 (54.8)	1635	15.3	1 (ref)	1 (ref)
20 <sup>b</sup>	1890 (20.4)	205	10.8	0.56 (0.47 to 0.65)	0.62 (0.53 to 0.74)	3260 (21.8)	415	12.7	0.45 (0.40 to 0.50)	0.50 (0.44 to 0.56)	4250 (21.8)	310	7.3	0.42 (0.37 to 0.48)	0.52 (0.46 to 0.60)
Ethnicity															
White	8950 (96.7)	1905	21.3	1 (ref)	1 (ref)	13,480 (90.0)	3635	27	1 (ref)	1 (ref)	17,280 (88.5)	3180	18.4	1 (ref)	1 (ref)
South Asian	55 (0.6)	–	–	0.45 (0.20 to 1.01)	0.58 (0.24 to 1.37)	315 (2.1)	45	14.3	0.40 (0.29 to 0.56)	0.61 (0.44 to 0.86)	650 (3.3)	55	8.5	0.42 (0.32 to 0.55)	0.60 (0.45 to 0.80)
Black	20 (0.2)	–	–	0.68 (0.19 to 2.37)	0.89 (0.24 to 3.36)	240 (1.6)	50	20.8	0.81 (0.59 to 1.12)	1.05 (0.75 to 1.48)	270 (1.4)	40	14.8	0.87 (0.62 to 1.23)	1.11 (0.77 to 1.60)
Mixed/other	110 (1.2)	10	9.1	0.44 (0.24 to 0.80)	0.50 (0.26 to 0.93)	545 (3.6)	120	22	0.81 (0.65 to 1.00)	0.97 (0.77 to 1.23)	860 (4.4)	110	12.8	0.64 (0.52 to 0.79)	0.69 (0.55 to 0.85)
Unknown	125 (1.3)	10	8	0.33 (0.17 to 0.63)	0.37 (0.19 to 0.73)	390 (2.6)	45	11.5	0.40 (0.29 to 0.54)	0.50 (0.36 to 0.70)	465 (2.4)	60	12.9	0.59 (0.44 to 0.78)	0.71 (0.53 to 0.95)
IMD (quintile)															
Least deprived	240 (2.6)	40	16.7	0.89 (0.60 to 1.32)	0.90 (0.60 to 1.36)	385 (2.6)	100	26	0.87 (0.66 to 1.14)	0.95 (0.72 to 1.27)	410 (2.1)	55	13.4	0.86 (0.63 to 1.19)	0.93 (0.66 to 1.29)
2	465 (5.0)	90	19.4	1.14 (0.85 to 1.53)	1.15 (0.85 to 1.57)	670 (4.5)	165	24.6	0.91 (0.73 to 1.14)	0.92 (0.73 to 1.17)	1270 (6.5)	175	13.8	0.88 (0.71 to 1.08)	0.89 (0.72 to 1.11)

	North-East					North-West					Yorkshire and the Humber				
	N eligible mothers	N enrolled in FNP	% enrolled in FNP	Crude OR (95% CI)	Adjusted <sup>a</sup> OR (95% CI)	N eligible mothers	N enrolled in FNP	% enrolled in FNP	Crude OR (95% CI)	Adjusted <sup>a</sup> OR (95% CI)	N eligible mothers	N enrolled in FNP	% enrolled in FNP	Crude OR (95% CI)	Adjusted <sup>a</sup> OR (95% CI)
3	835 (9.0)	140	16.8	1 (ref)	1 (ref)	1295 (8.7)	320	24.7	1 (ref)	1 (ref)	1940 (9.9)	315	16.2	1 (ref)	1 (ref)
4	2295 (24.8)	490	21.4	1.33 (1.08 to 1.63)	1.23 (0.99 to 1.53)	2635 (17.6)	665	25.2	0.99 (0.85 to 1.17)	0.94 (0.80 to 1.12)	4340 (22.2)	765	17.6	1.11 (0.96 to 1.28)	1.07 (0.92 to 1.25)
Most deprived	5420 (58.5)	1175	21.7	1.35 (1.11 to 1.63)	1.21 (0.99 to 1.48)	9960 (66.5)	2615	26.3	1.12 (0.97 to 1.29)	0.97 (0.83 to 1.14)	11,570 (59.2)	2130	18.4	1.26 (1.10 to 1.44)	1.08 (0.94 to 1.25)
Unknown	-	-	-	-	-	25 (0.2)	25	100	-	-	-	-	-	-	-
Admission with diagnoses within 2 years before 20 weeks of pregnancy															
Mental health (excluding substance misuse and self-harm)	180 (1.9)	60	33.3	1.93 (1.41 to 2.64)	1.41 (0.96 to 2.06)	430 (2.9)	200	46.5	2.35 (1.93 to 2.87)	1.56 (1.21 to 2.00)	305 (1.6)	95	31.1	2.13 (1.66 to 2.74)	1.57 (1.16 to 2.13)
Adversity-related	445 (4.8)	145	32.6	1.96 (1.60 to 2.41)	1.15 (0.84 to 1.57)	795 (5.3)	365	45.9	2.56 (2.21 to 2.98)	1.51 (1.22 to 1.88)	725 (3.7)	225	31	2.17 (1.84 to 2.56)	1.09 (0.86 to 1.40)
Any chronic condition	880 (9.5)	245	27.8	1.52 (1.30 to 1.78)	1.09 (0.85 to 1.39)	1665 (11.1)	615	36.9	1.73 (1.55 to 1.93)	1.01 (0.86 to 1.20)	1545 (7.9)	395	25.6	1.67 (1.48 to 1.89)	1.17 (0.98 to 1.41)
A&E attendances	6115 (66.0)	1390	22.7	1.35 (1.21 to 1.51)	1.24 (1.10 to 1.40)	10,170 (67.9)	2910	28.6	1.52 (1.40 to 1.65)	1.30 (1.18 to 1.43)	12,090 (61.9)	2375	19.6	1.44 (1.33 to 1.56)	1.26 (1.16 to 1.38)
Gestational age at antenatal booking appointment															
Before 10 weeks	3170 (34.2)	685	21.6	1 (ref)	1 (ref)	4245 (28.4)	1155	27.2	1 (ref)	1 (ref)	4070 (20.8)	785	19.3	1 (ref)	1 (ref)
10-20 weeks	4140 (44.7)	830	20	0.92 (0.82 to 1.04)	0.83 (0.74 to 0.94)	5975 (39.9)	1560	26.1	0.92 (0.84 to 1.01)	0.89 (0.81 to 0.99)	5555 (28.4)	865	15.6	0.75 (0.67 to 0.84)	0.74 (0.65 to 0.83)
20 weeks or more	490 (5.3)	80	16.3	0.74 (0.57 to 0.95)	0.51 (0.39 to 0.67)	740 (4.9)	200	27	0.91 (0.76 to 1.09)	0.72 (0.59 to 0.88)	785 (4.0)	195	24.8	1.21 (1.00 to 1.46)	0.98 (0.80 to 1.20)
															continued

**TABLE 39** Predictors of enrolment in the FNP by English region, among mothers aged 13–19 at LMP, living in a LA with an active FNP site at the time of first antenatal appointment – England, births between April 2010 and March 2017 (continued)

	North-East					North-West					Yorkshire and the Humber				
	N eligible mothers	N enrolled in FNP	% enrolled in FNP	Crude OR (95% CI)	Adjusted <sup>a</sup> OR (95% CI)	N eligible mothers	N enrolled in FNP	% enrolled in FNP	Crude OR (95% CI)	Adjusted <sup>a</sup> OR (95% CI)	N eligible mothers	N enrolled in FNP	% enrolled in FNP	Crude OR (95% CI)	Adjusted <sup>a</sup> OR (95% CI)
Unknown	1465 (15.8)	345	23.5	1.28 (1.09 to 1.50)	1.08 (0.91 to 1.28)	4010 (26.8)	985	24.6	0.80 (0.72 to 0.89)	0.69 (0.61 to 0.77)	9,120 (46.7)	1595	17.5	1.01 (0.90 to 1.13)	0.87 (0.77 to 0.99)
Linked to NPD															
Linked to NPD	8195 (88.5)	1780	21.7	1 (ref)	1 (ref)	12,400 (82.8)	3475	28	1 (ref)	1 (ref)	16,760 (85.8)	3195	19.1	1 (ref)	1 (ref)
Not linked to NPD	1030 (11.1)	155	15	0.66 (0.55 to 0.78)	1.15 (0.91 to 1.44)	2480 (16.6)	410	16.5	0.50 (0.45 to 0.56)	0.91 (0.78 to 1.07)	2645 (13.5)	240	9.1	0.43 (0.38 to 0.50)	0.86 (0.72 to 1.02)
Linked to NPD but not to NPD census	35 (0.4)	–	–	0.48 (0.17 to 1.35)	1.22 (0.42 to 3.53)	90 (0.6)	10	11.1	0.28 (0.14 to 0.57)	0.41 (0.20 to 0.85)	120 (0.6)	–	–	0.27 (0.13 to 0.58)	0.45 (0.21 to 0.99)
Ever had a CPP or was looked after before 20 weeks of pregnancy															
No CPP or Looked After	7590 (82.0)	1530	20.2	1 (ref)	1 (ref)	11,440 (76.4)	2955	25.8	1 (ref)	1 (ref)	15,830 (81.1)	2785	17.6	1 (ref)	1 (ref)
Looked After (CPP)	475 (5.1)	185	38.9	2.58 (2.12 to 3.13)	2.02 (1.63 to 2.49)	795 (5.3)	400	50.3	2.92 (2.51 to 3.40)	2.20 (1.86 to 2.59)	765 (3.9)	295	38.6	3.03 (2.60 to 3.54)	2.31 (1.96 to 2.73)
CPP, but not Looked After	170 (1.8)	65	38.2	2.37 (1.73 to 3.26)	1.37 (0.98 to 1.93)	255 (1.7)	125	49	2.58 (2.00 to 3.34)	1.52 (1.15 to 1.99)	290 (1.5)	125	43.1	3.49 (2.74 to 4.44)	1.95 (1.51 to 2.51)
Not linked to NPD	1030 (11.1)	155	15	0.72 (0.60 to 0.86)	– <sup>c</sup>	2480 (16.6)	410	16.5	0.56 (0.50 to 0.63)	– <sup>c</sup>	2645 (13.5)	240	9.1	0.48 (0.42 to 0.55)	– <sup>c</sup>

	North-East					North-West					Yorkshire and the Humber				
	N eligible mothers	N enrolled in FNP	% enrolled in FNP	Crude OR (95% CI)	Adjusted <sup>a</sup> OR (95% CI)	N eligible mothers	N enrolled in FNP	% enrolled in FNP	Crude OR (95% CI)	Adjusted <sup>a</sup> OR (95% CI)	N eligible mothers	N enrolled in FNP	% enrolled in FNP	Crude OR (95% CI)	Adjusted <sup>a</sup> OR (95% CI)
Ever recorded as having SEN before 20 weeks of pregnancy															
No	4345 (46.9)	795	18.3	1 (ref)	1 (ref)	6235 (41.6)	1435	23	1 (ref)	1 (ref)	8630 (44.2)	1290	14.9	1 (ref)	1 (ref)
Yes	3850 (41.6)	980	25.5	1.51 (1.36 to 1.68)	1.16 (1.02 to 1.31)	6160 (41.1)	2040	33.1	1.60 (1.48 to 1.74)	1.23 (1.12 to 1.36)	8130 (41.6)	1905	23.4	1.75 (1.62 to 1.90)	1.23 (1.12 to 1.34)
Not linked to NPD	1030 (11.1)	155	15	0.81 (0.67 to 0.97)	<sup>-c</sup>	2480 (16.6)	410	16.5	0.65 (0.57 to 0.73)	<sup>-c</sup>	2645 (13.5)	240	9.1	0.58 (0.50 to 0.68)	<sup>-c</sup>
Linked to NPD but not to NPD census	35 (0.4)	-	-	0.58 (0.20 to 1.65)	<sup>-c</sup>	90 (0.6)	10	11.1	0.36 (0.18 to 0.73)	<sup>-c</sup>	120 (0.6)	-	-	0.36 (0.17 to 0.78)	<sup>-c</sup>
Ever recorded as receiving FSM before 20 weeks of pregnancy															
No	3340 (36.1)	530	15.9	1 (ref)	1 (ref)	4660 (31.1)	1015	21.8	1 (ref)	1 (ref)	7855 (40.2)	1150	14.6	1 (ref)	1 (ref)
Yes	4855 (52.4)	1250	25.7	1.79 (1.60 to 2.01)	1.24 (1.09 to 1.41)	7740 (51.7)	2455	31.7	1.62 (1.48 to 1.76)	1.18 (1.07 to 1.31)	8910 (45.6)	2040	22.9	1.74 (1.60 to 1.88)	1.15 (1.05 to 1.26)
Not linked to NPD	1030 (11.1)	155	15	0.95 (0.78 to 1.15)	<sup>-c</sup>	2480 (16.6)	410	16.5	0.70 (0.61 to 0.79)	<sup>-c</sup>	2645 (13.5)	240	9.1	0.59 (0.51 to 0.69)	<sup>-c</sup>
Linked to NPD but not to NPD census	35 (0.4)	-	-	0.68 (0.24 to 1.94)	<sup>-c</sup>	90 (0.6)	10	11.1	0.39 (0.19 to 0.78)	<sup>-c</sup>	120 (0.6)	-	-	0.37 (0.17 to 0.79)	<sup>-c</sup>
Ever in IDACI bottom decile before 20 weeks of pregnancy															
No	4655 (50.3)	895	19.2	1 (ref)	1 (ref)	6170 (41.2)	1585	25.7	1 (ref)	1 (ref)	10,525 (53.9)	1810	17.2	1 (ref)	1 (ref)

continued



**TABLE 39** Predictors of enrolment in the FNP by English region, among mothers aged 13–19 at LMP, living in a LA with an active FNP site at the time of first antenatal appointment – England, births between April 2010 and March 2017 (continued)

	North-East					North-West					Yorkshire and the Humber				
	N eligible mothers	N enrolled in FNP	% enrolled in FNP	Crude OR (95% CI)	Adjusted <sup>a</sup> OR (95% CI)	N eligible mothers	N enrolled in FNP	% enrolled in FNP	Crude OR (95% CI)	Adjusted <sup>a</sup> OR (95% CI)	N eligible mothers	N enrolled in FNP	% enrolled in FNP	Crude OR (95% CI)	Adjusted <sup>a</sup> OR (95% CI)
Yes	3540 (38.2)	885	25	1.38 (1.23 to 1.53)	1.10 (0.97 to 1.24)	6230 (41.6)	1885	30.3	1.30 (1.19 to 1.41)	1.02 (0.92 to 1.12)	6235 (31.9)	1380	22.1	1.44 (1.33 to 1.56)	1.11 (1.02 to 1.22)
Not linked to NPD	1030 (11.1)	155	15	0.76 (0.63 to 0.92)	– <sup>c</sup>	2480 (16.6)	410	16.5	0.58 (0.51 to 0.66)	– <sup>c</sup>	2645 (13.5)	240	9.1	0.50 (0.43 to 0.58)	– <sup>c</sup>
Linked to NPD but not to NPD census	35 (0.4)	–	–	0.55 (0.19 to 1.56)	– <sup>c</sup>	90 (0.6)	10	11.1	0.33 (0.16 to 0.66)	– <sup>c</sup>	120 (0.6)	–	–	0.31 (0.14 to 0.67)	– <sup>c</sup>
Educational attainment before 20 weeks of pregnancy															
Did not achieve 5 A*–C GCSEs	5905 (63.8)	1155	19.6	1 (ref)	1 (ref)	9290 (62.1)	2475	26.6	1 (ref)	1 (ref)	12,640 (64.7)	2285	18.1	1 (ref)	1 (ref)
Achieved 5 A*–C GCSEs	1660 (17.9)	290	17.5	0.88 (0.76 to 1.01)	1.16 (1.00 to 1.36)	2345 (15.7)	545	23.2	0.75 (0.67 to 0.84)	1.04 (0.92 to 1.18)	2935 (15.0)	380	12.9	0.65 (0.58 to 0.74)	0.95 (0.83 to 1.08)
Not linked to NPD	1030 (11.1)	155	15	0.75 (0.62 to 0.90)	– <sup>c</sup>	2480 (16.6)	410	16.5	0.53 (0.47 to 0.60)	– <sup>c</sup>	2645 (13.5)	240	9.1	0.46 (0.40 to 0.53)	– <sup>c</sup>
Had not attempted GCSEs	665 (7.2)	335	50.4	4.13 (3.50 to 4.87)	1.93 (1.56 to 2.39)	855 (5.7)	465	54.4	3.47 (2.99 to 4.02)	1.50 (1.25 to 1.80)	1310 (6.7)	530	40.5	3.13 (2.77 to 3.54)	1.33 (1.14 to 1.56)
Ever excluded, in PRU, or alternative provision															
No	6260 (67.6)	1240	19.8	1 (ref)	1 (ref)	8710 (58.2)	2210	25.4	1 (ref)	1 (ref)	12,025 (61.6)	2005	16.7	1 (ref)	1 (ref)
Yes	1975 (21.3)	540	27.3	1.56 (1.38 to 1.75)	1.09 (0.95 to 1.24)	3780 (25.3)	1270	33.6	1.58 (1.45 to 1.72)	1.02 (0.92 to 1.12)	4860 (24.9)	1195	24.6	1.67 (1.54 to 1.81)	1.10 (1.00 to 1.21)

	North-East					North-West					Yorkshire and the Humber				
	N eligible mothers	N enrolled in FNP	% enrolled in FNP	Crude OR (95% CI)	Adjusted <sup>a</sup> OR (95% CI)	N eligible mothers	N enrolled in FNP	% enrolled in FNP	Crude OR (95% CI)	Adjusted <sup>a</sup> OR (95% CI)	N eligible mothers	N enrolled in FNP	% enrolled in FNP	Crude OR (95% CI)	Adjusted <sup>a</sup> OR (95% CI)
Not linked to NPD	1030 (11.1)	155	15	0.74 (0.62 to 0.89)	- <sup>c</sup>	2480 (16.6)	410	16.5	0.58 (0.52 to 0.66)	- <sup>c</sup>	2645 (13.5)	240	9.1	0.51 (0.45 to 0.59)	- <sup>c</sup>
Ever persistently absent in a term (≥10% possible sessions)															
No	5035 (54.4)	805	16	1 (ref)	1 (ref)	7790 (52.0)	1610	20.7	1 (ref)	1 (ref)	10,270 (52.6)	1295	12.6	1 (ref)	1 (ref)
Yes	3200 (34.6)	980	30.6	2.35 (2.11 to 2.62)	1.19 (1.03 to 1.36)	4700 (31.4)	1875	39.9	2.72 (2.51 to 2.96)	1.41 (1.27 to 1.56)	6615 (33.9)	1905	28.8	2.88 (2.66 to 3.12)	1.46 (1.32 to 1.62)
Not linked to NPD	1030 (11.1)	155	15	0.97 (0.80 to 1.16)	- <sup>c</sup>	2480 (16.6)	410	16.5	0.77 (0.69 to 0.88)	- <sup>c</sup>	2645 (13.5)	240	9.1	0.72 (0.62 to 0.83)	- <sup>c</sup>

**TABLE 39** Predictors of enrolment in the FNP by English region, among mothers aged 13–19 at LMP, living in a LA with an active FNP site at the time of first antenatal appointment – England, births between April 2010 and March 2017 (continued)

	East Midlands					West Midlands					East of England					
	N eligible mothers	N enrolled in FNP	% enrolled in FNP	Crude OR (95% CI)	Adjusted <sup>a</sup> OR (95% CI)	N eligible mothers	N enrolled in FNP	% enrolled in FNP	Crude OR (95% CI)	Adjusted <sup>a</sup> OR (95% CI)	N eligible mothers	N enrolled in FNP	% enrolled in FNP	Crude OR (95% CI)	Adjusted <sup>a</sup> OR (95% CI)	
<b>Total</b>	10,545	2160	20.5	–	–	15,250	3435	22.5	–	–	9890	2085	21.1	–	–	
<b>Maternal age at birth</b>																
13–15	255 (2.4)	145	56.9	6.57 (5.05 to 8.55)	3.48 (2.50 to 4.85)	330 (2.2)	160	48.5	3.99 (3.18 to 5.01)	2.13 (1.61 to 2.83)	200 (2.0)	95	47.5	4.09 (3.06 to 5.48)	2.21 (1.54 to 3.16)	
16–17	2235 (21.2)	865	38.7	3.06 (2.74 to 3.42)	2.08 (1.81 to 2.39)	3275 (21.5)	1160	35.4	2.21 (2.02 to 2.42)	1.59 (1.42 to 1.78)	2090 (21.1)	740	35.4	2.44 (2.18 to 2.74)	1.71 (1.49 to 1.97)	
18–19	5710 (54.1)	995	17.4	1 (ref)	1 (ref)	8270 (54.2)	1735	21	1 (ref)	1 (ref)	5505 (55.7)	1030	18.7	1 (ref)	1 (ref)	
20 <sup>b</sup>	2340 (22.2)	155	6.6	0.33 (0.28 to 0.40)	0.41 (0.34 to 0.50)	3375 (22.1)	380	11.3	0.47 (0.42 to 0.54)	0.56 (0.49 to 0.63)	2095 (21.2)	220	10.5	0.52 (0.45 to 0.61)	0.62 (0.52 to 0.73)	
<b>Ethnicity</b>																
White	9215 (87.4)	1895	20.6	1 (ref)	1 (ref)	12,680 (83.1)	3005	23.7	1 (ref)	1 (ref)	9080 (91.8)	1920	21.1	1 (ref)	1 (ref)	
South Asian	205 (1.9)	35	17.1	0.68 (0.47 to 0.98)	0.94 (0.63 to 1.42)	575 (3.8)	70	12.2	0.47 (0.36 to 0.60)	0.63 (0.48 to 0.83)	110 (1.1)	15	13.6	0.54 (0.31 to 0.94)	0.78 (0.44 to 1.39)	
Black	165 (1.6)	25	15.2	0.67 (0.44 to 1.02)	0.91 (0.57 to 1.44)	445 (2.9)	105	23.6	1.02 (0.81 to 1.28)	1.21 (0.95 to 1.54)	90 (0.9)	25	27.8	1.11 (0.68 to 1.81)	1.33 (0.80 to 2.23)	
Mixed/other	520 (4.9)	120	23.1	0.89 (0.71 to 1.10)	0.91 (0.72 to 1.16)	1020 (6.7)	170	16.7	0.67 (0.57 to 0.80)	0.75 (0.63 to 0.90)	250 (2.5)	60	24	1.05 (0.77 to 1.41)	1.18 (0.86 to 1.63)	
Unknown	440 (4.2)	80	18.2	0.76 (0.59 to 0.98)	0.94 (0.71 to 1.24)	530 (3.5)	85	16	0.57 (0.45 to 0.73)	0.70 (0.55 to 0.91)	360 (3.6)	65	18.1	0.68 (0.52 to 0.90)	0.77 (0.58 to 1.04)	
<b>IMD (quintile)</b>																
Least deprived	675 (6.4)	105	15.6	0.95 (0.73 to 1.22)	1.15 (0.88 to 1.52)	525 (3.4)	125	23.8	0.96 (0.76 to 1.22)	1.06 (0.83 to 1.36)	1045 (10.6)	150	14.4	0.67 (0.55 to 0.83)	0.69 (0.56 to 0.86)	
2	830 (7.9)	145	17.5	1.04 (0.83 to 1.31)	1.20 (0.94 to 1.54)	920 (6.0)	230	25	1.06 (0.87 to 1.28)	1.08 (0.88 to 1.32)	1530 (15.5)	270	17.6	0.85 (0.72 to 1.01)	0.85 (0.72 to 1.02)	
3	1455 (13.8)	260	17.9	1 (ref)	1 (ref)	1785 (11.7)	395	22.1	1 (ref)	1 (ref)	2330 (23.6)	470	20.2	1 (ref)	1 (ref)	

	East Midlands					West Midlands					East of England				
	N eligible mothers	N enrolled in FNP	% enrolled in FNP	Crude OR (95% CI)	Adjusted <sup>a</sup> OR (95% CI)	N eligible mothers	N enrolled in FNP	% enrolled in FNP	Crude OR (95% CI)	Adjusted <sup>a</sup> OR (95% CI)	N eligible mothers	N enrolled in FNP	% enrolled in FNP	Crude OR (95% CI)	Adjusted <sup>a</sup> OR (95% CI)
4	2825 (26.8)	565	20	1.10 (0.93 to 1.30)	1.07 (0.89 to 1.27)	3220 (21.1)	730	22.7	1.11 (0.96 to 1.28)	1.07 (0.92 to 1.24)	2660 (26.9)	560	21.1	0.99 (0.86 to 1.14)	0.99 (0.85 to 1.14)
Most deprived	4745 (45.0)	1075	22.7	1.20 (1.02 to 1.40)	1.05 (0.88 to 1.25)	8785 (57.6)	1940	22.1	1.21 (1.06 to 1.39)	1.11 (0.96 to 1.27)	2325 (23.5)	635	27.3	1.35 (1.17 to 1.56)	1.35 (1.16 to 1.58)
Unknown	10 (0.1)	10	100	-	-	15 (0.1)	15	100	-	-	-	-	-	-	-
<b>Admission with diagnoses within 2 years before 20 weeks of pregnancy</b>															
Mental health (excluding substance misuse and self-harm)	255 (2.4)	80	31.4	1.89 (1.43 to 2.48)	1.15 (0.81 to 1.64)	310 (2.0)	125	40.3	2.30 (1.82 to 2.91)	1.44 (1.07 to 1.94)	250 (2.5)	90	36	2.30 (1.76 to 3.00)	1.36 (0.96 to 1.94)
Adversity-related	470 (4.5)	175	37.2	2.49 (2.04 to 3.03)	1.61 (1.18 to 2.20)	550 (3.6)	205	37.3	2.09 (1.74 to 2.51)	0.97 (0.75 to 1.25)	365 (3.7)	140	38.4	2.62 (2.10 to 3.27)	1.30 (0.95 to 1.80)
Any chronic condition	945 (9.0)	270	28.6	1.68 (1.44 to 1.96)	0.99 (0.77 to 1.28)	1250 (8.2)	420	33.6	1.77 (1.56 to 2.02)	1.32 (1.10 to 1.58)	820 (8.3)	250	30.5	1.80 (1.53 to 2.11)	1.17 (0.92 to 1.49)
A&E attendances	6200 (58.8)	1420	22.9	1.45 (1.31 to 1.61)	1.31 (1.17 to 1.47)	9325 (61.1)	2330	25	1.40 (1.29 to 1.52)	1.25 (1.14 to 1.36)	5785 (58.5)	1360	23.5	1.47 (1.33 to 1.63)	1.26 (1.12 to 1.40)
<b>Gestational age at antenatal booking appointment</b>															
Before 10 weeks	3485 (33.0)	650	18.7	1 (ref)	1 (ref)	3515 (23.0)	750	21.3	1 (ref)	1 (ref)	3400 (34.4)	695	20.4	1 (ref)	1 (ref)
10–20 weeks	3870 (36.7)	800	20.7	0.99 (0.88 to 1.11)	0.96 (0.84 to 1.09)	4545 (29.8)	1065	23.4	1.01 (0.90 to 1.13)	1.00 (0.89 to 1.12)	3420 (34.6)	655	19.2	0.93 (0.82 to 1.05)	0.91 (0.80 to 1.03)
20 weeks or more	790 (7.5)	200	25.3	1.05 (0.86 to 1.28)	0.83 (0.67 to 1.02)	945 (6.2)	265	28	1.02 (0.85 to 1.23)	0.84 (0.69 to 1.03)	435 (4.4)	85	19.5	0.92 (0.72 to 1.19)	0.83 (0.64 to 1.10)
Unknown	2400 (22.8)	510	21.3	0.95 (0.82 to 1.09)	0.86 (0.74 to 1.00)	6250 (41.0)	1355	21.7	0.75 (0.66 to 0.85)	0.73 (0.64 to 0.83)	2635 (26.6)	650	24.7	1.13 (0.99 to 1.28)	1.03 (0.90 to 1.18)

continued

**TABLE 39** Predictors of enrolment in the FNP by English region, among mothers aged 13–19 at LMP, living in a LA with an active FNP site at the time of first antenatal appointment – England, births between April 2010 and March 2017 (continued)

	East Midlands					West Midlands					East of England				
	N eligible mothers	N enrolled in FNP	% enrolled in FNP	Crude OR (95% CI)	Adjusted <sup>a</sup> OR (95% CI)	N eligible mothers	N enrolled in FNP	% enrolled in FNP	Crude OR (95% CI)	Adjusted <sup>a</sup> OR (95% CI)	N eligible mothers	N enrolled in FNP	% enrolled in FNP	Crude OR (95% CI)	Adjusted <sup>a</sup> OR (95% CI)
<b>Linked to NPD</b>															
Linked to NPD	9070 (86.0)	1995	22	1 (ref)	1 (ref)	13,130 (86.1)	3190	24.3	1 (ref)	1 (ref)	8420 (85.1)	1920	22.8	1 (ref)	1 (ref)
Not linked to NPD	1400 (13.3)	155	11.1	0.41 (0.34 to 0.49)	0.90 (0.72 to 1.12)	1990 (13.0)	225	11.3	0.41 (0.35 to 0.47)	0.74 (0.62 to 0.89)	1410 (14.3)	160	11.3	0.42 (0.35 to 0.50)	0.79 (0.64 to 0.98)
Linked to NPD but not to NPD census	75 (0.7)	10	13.3	0.39 (0.19 to 0.83)	0.60 (0.26 to 1.38)	130 (0.9)	15	11.5	0.52 (0.31 to 0.87)	0.81 (0.47 to 1.38)	55 (0.6)	–	–	0.56 (0.25 to 1.26)	0.93 (0.41 to 2.13)
<b>Ever had a CPP or was looked after before 20 weeks of pregnancy</b>															
No CPP or Looked After	8460 (80.2)	1710	20.2	1 (ref)	1 (ref)	12,290 (80.6)	2805	22.8	1 (ref)	1 (ref)	7860 (79.5)	1670	21.2	1 (ref)	1 (ref)
Looked After (CPP)	500 (4.7)	190	38	2.47 (2.04 to 3.00)	1.69 (1.37 to 2.10)	745 (4.9)	315	42.3	2.43 (2.08 to 2.84)	1.89 (1.60 to 2.23)	485 (4.9)	200	41.2	2.66 (2.19 to 3.22)	1.92 (1.56 to 2.36)
CPP, but not looked after	190 (1.8)	105	55.3	5.27 (3.91 to 7.11)	2.60 (1.87 to 3.61)	225 (1.5)	90	40	2.16 (1.63 to 2.84)	1.24 (0.92 to 1.66)	130 (1.3)	55	42.3	2.46 (1.71 to 3.52)	1.25 (0.85 to 1.84)
Not linked to NPD	1400 (13.3)	155	11.1	0.46 (0.38 to 0.54)	– <sup>c</sup>	1990 (13.0)	225	11.3	0.44 (0.38 to 0.51)	– <sup>c</sup>	1410 (14.3)	160	11.3	0.46 (0.39 to 0.55)	– <sup>c</sup>
<b>Ever recorded as having SEN before 20 weeks of pregnancy</b>															
No	4210 (39.9)	695	16.5	1 (ref)	1 (ref)	6920 (45.4)	1515	21.9	1 (ref)	1 (ref)	4175 (42.2)	770	18.4	1 (ref)	1 (ref)
Yes	4860 (46.1)	1305	26.9	1.88 (1.69 to 2.08)	1.34 (1.19 to 1.51)	6210 (40.7)	1675	27	1.31 (1.21 to 1.42)	1.05 (0.96 to 1.15)	4245 (42.9)	1150	27.1	1.74 (1.56 to 1.93)	1.34 (1.19 to 1.50)
Not linked to NPD	1400 (13.3)	155	11.1	0.59 (0.49 to 0.71)	– <sup>c</sup>	1990 (13.0)	225	11.3	0.47 (0.40 to 0.54)	– <sup>c</sup>	1410 (14.3)	160	11.3	0.57 (0.47 to 0.68)	– <sup>c</sup>

	East Midlands					West Midlands					East of England				
	N eligible mothers	N enrolled in FNP	% enrolled in FNP	Crude OR (95% CI)	Adjusted <sup>a</sup> OR (95% CI)	N eligible mothers	N enrolled in FNP	% enrolled in FNP	Crude OR (95% CI)	Adjusted <sup>a</sup> OR (95% CI)	N eligible mothers	N enrolled in FNP	% enrolled in FNP	Crude OR (95% CI)	Adjusted <sup>a</sup> OR (95% CI)
Linked to NPD but not to NPD census	75 (0.7)	10	13.3	0.57 (0.27 to 1.20)	- <sup>c</sup>	130 (0.9)	15	11.5	0.60 (0.36 to 1.00)	- <sup>c</sup>	55 (0.6)	-	-	0.76 (0.34 to 1.70)	- <sup>c</sup>
<b>Ever recorded as receiving FSM before 20 weeks of pregnancy</b>															
No	4295 (40.7)	645	15	1 (ref)	1 (ref)	5750 (37.7)	1130	19.7	1 (ref)	1 (ref)	4245 (42.9)	760	17.9	1 (ref)	1 (ref)
Yes	4775 (45.3)	1350	28.3	2.06 (1.85 to 2.29)	1.40 (1.24 to 1.58)	7380 (48.4)	2060	27.9	1.61 (1.48 to 1.75)	1.22 (1.11 to 1.34)	4175 (42.2)	1155	27.7	1.70 (1.53 to 1.89)	1.18 (1.05 to 1.33)
Not linked to NPD	1400 (13.3)	155	11.1	0.63 (0.52 to 0.76)	- <sup>c</sup>	1990 (13.0)	225	11.3	0.54 (0.47 to 0.64)	- <sup>c</sup>	1410 (14.3)	160	11.3	0.56 (0.46 to 0.67)	- <sup>c</sup>
Linked to NPD but not to NPD census	75 (0.7)	10	13.3	0.61 (0.29 to 1.28)	- <sup>c</sup>	130 (0.9)	15	11.5	0.71 (0.42 to 1.19)	- <sup>c</sup>	55 (0.6)	-	-	0.75 (0.33 to 1.66)	- <sup>c</sup>
<b>Ever in IDACI bottom decile before 20 weeks of pregnancy</b>															
No	6135 (58.2)	1170	19.1	1 (ref)	1 (ref)	8465 (55.5)	2000	23.6	1 (ref)	1 (ref)	6830 (69.1)	1465	21.4	1 (ref)	1 (ref)
Yes	2935 (27.8)	830	28.3	1.40 (1.25 to 1.56)	1.04 (0.91 to 1.18)	4665 (30.6)	1190	25.5	1.26 (1.15 to 1.37)	1.04 (0.94 to 1.15)	1590 (16.1)	450	28.3	1.36 (1.20 to 1.55)	0.98 (0.85 to 1.14)
Not linked to NPD	1400 (13.3)	155	11.1	0.47 (0.39 to 0.56)	- <sup>c</sup>	1990 (13.0)	225	11.3	0.45 (0.38 to 0.52)	- <sup>c</sup>	1410 (14.3)	160	11.3	0.45 (0.37 to 0.53)	- <sup>c</sup>
Linked to NPD but not to NPD census	75 (0.7)	10	13.3	0.46 (0.22 to 0.96)	- <sup>c</sup>	130 (0.9)	15	11.5	0.58 (0.35 to 0.97)	- <sup>c</sup>	55 (0.6)	-	-	0.60 (0.27 to 1.34)	- <sup>c</sup>
<b>Educational attainment before 20 weeks of pregnancy</b>															
Did not achieve 5 A*-C GCSEs	6805 (64.5)	1405	20.6	0.64 (0.55 to 0.75)	1 (ref)	9740 (63.9)	2190	22.5	1 (ref)	1 (ref)	6370 (64.4)	1375	21.6	1 (ref)	1 (ref)

continued

**TABLE 39** Predictors of enrolment in the FNP by English region, among mothers aged 13–19 at LMP, living in a LA with an active FNP site at the time of first antenatal appointment – England, births between April 2010 and March 2017 (continued)

	East Midlands					West Midlands					East of England				
	N eligible mothers	N enrolled in FNP	% enrolled in FNP	Crude OR (95% CI)	Adjusted <sup>a</sup> OR (95% CI)	N eligible mothers	N enrolled in FNP	% enrolled in FNP	Crude OR (95% CI)	Adjusted <sup>a</sup> OR (95% CI)	N eligible mothers	N enrolled in FNP	% enrolled in FNP	Crude OR (95% CI)	Adjusted <sup>a</sup> OR (95% CI)
Achieved 5 A*–C GCSEs	1615 (15.3)	230	14.2	0.45 (0.37 to 0.53)	0.94 (0.79 to 1.11)	2500 (16.4)	530	21.2	0.89 (0.80 to 1.00)	1.13 (1.00 to 1.27)	1495 (15.1)	265	17.7	0.76 (0.66 to 0.89)	1.11 (0.94 to 1.30)
Not linked to NPD	1400 (13.3)	155	11.1	4.17 (3.55 to 4.90)	– <sup>c</sup>	1990 (13.0)	225	11.3	0.45 (0.39 to 0.53)	– <sup>c</sup>	1410 (14.3)	160	11.3	0.45 (0.38 to 0.54)	– <sup>c</sup>
Had not attempted GCSEs	720 (6.8)	370	51.4	0.64 (0.55 to 0.75)	1.41 (1.15 to 1.73)	1020 (6.7)	490	48	3.46 (3.03 to 3.96)	1.76 (1.48 to 2.08)	615 (6.2)	285	46.3	3.26 (2.75 to 3.88)	1.55 (1.24 to 1.92)
<b>Ever excluded, in PRU, or alternative provision</b>															
No	6390 (60.6)	1270	19.9	1 (ref)	1 (ref)	9275 (60.8)	2030	21.9	1 (ref)	1 (ref)	5930 (60.0)	1205	20.3	1 (ref)	1 (ref)
Yes	2755 (26.1)	735	26.7	1.49 (1.34 to 1.66)	0.90 (0.80 to 1.02)	3985 (26.1)	1175	29.5	1.46 (1.34 to 1.59)	1.06 (0.96 to 1.16)	2550 (25.8)	720	28.2	1.58 (1.42 to 1.76)	1.05 (0.93 to 1.18)
Not linked to NPD	1400 (13.3)	155	11.1	0.47 (0.39 to 0.56)	– <sup>c</sup>	1990 (13.0)	225	11.3	0.46 (0.40 to 0.54)	– <sup>c</sup>	1410 (14.3)	160	11.3	0.49 (0.41 to 0.58)	– <sup>c</sup>
<b>Ever persistently absent in a term (≥ 10% possible sessions)</b>															
No	5545 (52.6)	735	13.3	1 (ref)	1 (ref)	8095 (53.1)	1455	18	1 (ref)	1 (ref)	5145 (52.0)	845	16.4	1 (ref)	1 (ref)
Yes	3600 (34.1)	1270	35.3	3.67 (3.30 to 4.08)	1.59 (1.40 to 1.82)	5165 (33.9)	1750	33.9	2.48 (2.28 to 2.69)	1.40 (1.26 to 1.55)	3330 (33.7)	1080	32.4	2.51 (2.26 to 2.79)	1.43 (1.25 to 1.63)
Not linked to NPD	1400 (13.3)	155	11.1	0.77 (0.63 to 0.92)	– <sup>c</sup>	1990 (13.0)	225	11.3	0.61 (0.52 to 0.71)	– <sup>c</sup>	1410 (14.3)	160	11.3	0.63 (0.53 to 0.76)	– <sup>c</sup>

	2013–14					2014–15					2015–16				
	N eligible mothers	N enrolled in FNP	% enrolled in FNP	Crude OR (95% CI)	Adjusted <sup>a</sup> OR (95% CI)	N eligible mothers	N enrolled in FNP	% enrolled in FNP	Crude OR (95% CI)	Adjusted <sup>a</sup> OR (95% CI)	N eligible mothers	N enrolled in FNP	% enrolled in FNP	Crude OR (95% CI)	Adjusted <sup>a</sup> OR (95% CI)
<b>Total</b>	<b>16,910</b>	<b>4070</b>	<b>24.1</b>	-	-	<b>16,275</b>	<b>3740</b>	<b>23</b>	-	-	<b>18,415</b>	<b>5590</b>	<b>30.4</b>	-	-
Maternal age at birth															
13–15	400 (2.4)	230	57.5	5.71 (4.61 to 7.08)	3.38 (2.59 to 4.42)	340 (2.1)	180	52.9	5.47 (4.31 to 6.93)	3.10 (2.31 to 4.16)	400 (2.2)	240	60	4.54 (3.67 to 5.61)	2.40 (1.85 to 3.12)
16–17	3530 (20.9)	1425	40.4	2.68 (2.46 to 2.93)	1.86 (1.67 to 2.07)	3340 (20.5)	1270	38	2.67 (2.43 to 2.93)	1.98 (1.77 to 2.22)	3665 (19.9)	1735	47.3	2.50 (2.30 to 2.71)	1.75 (1.58 to 1.94)
18–19	9295 (55.0)	2010	21.6	1 (ref)	1 (ref)	9010 (55.4)	1870	20.8	1 (ref)	1 (ref)	10,280 (55.8)	2900	28.2	1 (ref)	1 (ref)
20 <sup>b</sup>	3685 (21.8)	405	11	0.44 (0.39 to 0.49)	0.52 (0.46 to 0.59)	3590 (22.1)	415	11.6	0.47 (0.42 to 0.53)	0.53 (0.47 to 0.61)	4065 (22.1)	715	17.6	0.50 (0.46 to 0.56)	0.58 (0.52 to 0.64)
Ethnicity															
White	14,525 (85.9)	3565	24.5	1 (ref)	1 (ref)	13,665 (84.0)	3135	22.9	1 (ref)	1 (ref)	15,380 (83.5)	4780	31.1	1 (ref)	1 (ref)
South Asian	495 (2.9)	70	14.1	0.44 (0.33 to 0.58)	0.65 (0.48 to 0.87)	545 (3.3)	80	14.7	0.48 (0.37 to 0.63)	0.66 (0.50 to 0.87)	555 (3.0)	130	23.4	0.58 (0.47 to 0.72)	0.79 (0.63 to 0.99)
Black	545 (3.2)	155	28.4	1.16 (0.93 to 1.44)	1.37 (1.08 to 1.75)	550 (3.4)	180	32.7	1.17 (0.95 to 1.45)	1.27 (1.01 to 1.59)	590 (3.2)	215	36.4	1.18 (0.98 to 1.43)	1.34 (1.09 to 1.65)
Mixed/other	845 (5.0)	195	23.1	0.89 (0.75 to 1.07)	1.08 (0.89 to 1.30)	895 (5.5)	220	24.6	0.88 (0.74 to 1.05)	0.96 (0.79 to 1.15)	005 (5.5)	255	25.4	0.69 (0.59 to 0.81)	0.73 (0.62 to 0.87)
Unknown	500 (3.0)	85	17	0.54 (0.42 to 0.69)	0.62 (0.47 to 0.81)	625 (3.8)	125	20	0.65 (0.52 to 0.80)	0.81 (0.64 to 1.01)	885 (4.8)	205	23.2	0.63 (0.53 to 0.75)	0.78 (0.65 to 0.93)
IMD (quintile)															
Least deprived	890 (5.3)	210	23.6	0.81 (0.67 to 0.98)	0.94 (0.76 to 1.15)	815 (5.0)	145	17.8	0.78 (0.63 to 0.98)	0.82 (0.65 to 1.04)	1060 (5.8)	265	25	0.70 (0.59 to 0.84)	0.70 (0.59 to 0.84)
2	1345 (8.0)	300	22.3	0.83 (0.70 to 0.98)	0.90 (0.76 to 1.08)	1265 (7.8)	265	20.9	0.92 (0.77 to 1.10)	0.95 (0.78 to 1.14)	1500 (8.1)	405	27	0.86 (0.74 to 0.99)	0.89 (0.76 to 1.04)
3	2345 (13.9)	575	24.5	1 (ref)	1 (ref)	2145 (13.2)	465	21.7	1 (ref)	1 (ref)	2590 (14.1)	790	30.5	1 (ref)	1 (ref)

continued



**TABLE 39** Predictors of enrolment in the FNP by English region, among mothers aged 13–19 at LMP, living in a LA with an active FNP site at the time of first antenatal appointment – England, births between April 2010 and March 2017 (continued)

	2013–14					2014–15					2015–16					Adjusted <sup>a</sup> OR (95% CI)
	N eligible mothers	N enrolled in FNP	% enrolled in FNP	Crude OR (95% CI)	Adjusted <sup>a</sup> OR (95% CI)	N eligible mothers	N enrolled in FNP	% enrolled in FNP	Crude OR (95% CI)	Adjusted <sup>a</sup> OR (95% CI)	N eligible mothers	N enrolled in FNP	% enrolled in FNP	Crude OR (95% CI)		
4	4130 (24.4)	1015	24.6	1.01 (0.89 to 1.14)	0.98 (0.86 to 1.12)	4135 (25.4)	960	23.2	1.05 (0.91 to 1.20)	1.00 (0.87 to 1.16)	4640 (25.2)	1365	29.4	0.94 (0.84 to 1.05)	0.91 (0.81 to 1.02)	
Most deprived	8185 (48.4)	1955	23.9	1.09 (0.97 to 1.22)	1.01 (0.89 to 1.15)	7890 (48.5)	1880	23.8	1.19 (1.05 to 1.35)	1.08 (0.94 to 1.24)	8595 (46.7)	2745	31.9	1.09 (0.98 to 1.21)	1.02 (0.91 to 1.14)	
Unknown	15 (0.1)	15	100	–	–	25 (0.2)	25	100	–	–	25 (0.1)	25	100	–	–	
Admission with diagnoses within 2 years before 20 weeks of pregnancy																
Mental health (excluding substance misuse and self-harm)	310 (1.8)	125	40.3	2.27 (1.79 to 2.88)	1.88 (1.39 to 2.53)	370 (2.3)	145	39.2	2.49 (1.99 to 3.12)	1.61 (1.21 to 2.13)	555 (3.0)	260	46.8	2.16 (1.81 to 2.58)	1.37 (1.09 to 1.73)	
Adversity- related	605 (3.6)	225	37.2	2.06 (1.73 to 2.45)	1.33 (1.03 to 1.72)	670 (4.1)	270	40.3	2.59 (2.19 to 3.07)	1.38 (1.08 to 1.77)	825 (4.5)	415	50.3	2.62 (2.26 to 3.04)	1.30 (1.06 to 1.61)	
Any chronic condition	1375 (8.1)	415	30.2	1.46 (1.29 to 1.66)	0.89 (0.74 to 1.08)	1430 (8.8)	465	32.5	1.80 (1.59 to 2.03)	1.09 (0.90 to 1.32)	1790 (9.7)	755	42.2	1.83 (1.65 to 2.03)	1.18 (1.01 to 1.38)	
A&E attend- ances	10,615 (62.8)	2775	26.1	1.37 (1.27 to 1.48)	1.25 (1.14 to 1.36)	10,380 (63.8)	2635	25.4	1.47 (1.36 to 1.60)	1.25 (1.14 to 1.37)	11,865 (64.4)	3960	33.4	1.51 (1.41 to 1.63)	1.31 (1.21 to 1.42)	
Gestational age at antenatal booking appointment																
Before 10 weeks	4470 (26.4)	1060	23.7	1 (ref)	1 (ref)	4350 (26.7)	995	22.9	1 (ref)	1 (ref)	4940 (26.8)	1550	31.4	1 (ref)	1 (ref)	
10–20 weeks	5865 (34.7)	1430	24.4	0.96 (0.87 to 1.06)	0.91 (0.82 to 1.01)	5670 (34.8)	1365	24.1	0.91 (0.82 to 1.01)	0.87 (0.78 to 0.96)	6715 (36.5)	2105	31.3	0.92 (0.84 to 1.00)	0.89 (0.81 to 0.97)	
20 weeks or more	955 (5.6)	295	30.9	1.13 (0.96 to 1.34)	0.88 (0.73 to 1.06)	800 (4.9)	195	24.4	0.76 (0.62 to 0.92)	0.61 (0.49 to 0.75)	940 (5.1)	265	28.2	0.76 (0.64 to 0.89)	0.65 (0.54 to 0.77)	
Unknown	5620 (33.2)	1280	22.8	0.88 (0.78 to 0.99)	0.75 (0.66 to 0.86)	5455 (33.5)	1180	21.6	0.84 (0.75 to 0.95)	0.73 (0.64 to 0.83)	5815 (31.6)	1670	28.7	0.83 (0.75 to 0.92)	0.76 (0.68 to 0.85)	
Linked to NPD																
Linked to NPD	14,075 (83.2)	3665	26	1 (ref)	1 (ref)	13,815 (84.9)	3385	24.5	1 (ref)	1 (ref)	15,435 (83.8)	5035	32.6	1 (ref)	1 (ref)	

	2013–14					2014–15					2015–16					Adjusted <sup>a</sup> OR (95% CI)
	N eligible mothers	N enrolled in FNP	% enrolled in FNP	Crude OR (95% CI)	Adjusted <sup>a</sup> OR (95% CI)	N eligible mothers	N enrolled in FNP	% enrolled in FNP	Crude OR (95% CI)	Adjusted <sup>a</sup> OR (95% CI)	N eligible mothers	N enrolled in FNP	% enrolled in FNP	Crude OR (95% CI)		
Not linked to NPD	2720 (16.1)	390	14.3	0.41 (0.37 to 0.47)	0.78 (0.67 to 0.91)	2360 (14.5)	340	14.4	0.42 (0.37 to 0.48)	0.77 (0.65 to 0.92)	2870 (15.6)	540	18.8	0.45 (0.40 to 0.50)	0.79 (0.68 to 0.91)	
Linked to NPD but not to NPD census	115 (0.7)	15	13	0.32 (0.17 to 0.57)	0.54 (0.29 to 1.00)	105 (0.6)	15	14.3	0.40 (0.22 to 0.70)	0.57 (0.31 to 1.06)	110 (0.6)	10	9.1	0.23 (0.13 to 0.43)	0.33 (0.18 to 0.63)	
Ever had a CPP or was looked after before 20 weeks of pregnancy																
No CPP or Looked After	13,160 (77.8)	3220	24.5	1 (ref)	1 (ref)	12,715 (78.1)	2900	22.8	1 (ref)	1 (ref)	13,970 (75.9)	4195	30	1 (ref)	1 (ref)	
Looked After (CPP)	815 (4.8)	360	44.2	2.57 (2.21 to 2.99)	2.01 (1.71 to 2.37)	925 (5.7)	380	41.1	2.68 (2.31 to 3.10)	1.99 (1.69 to 2.33)	1095 (5.9)	610	55.7	3.07 (2.70 to 3.50)	2.36 (2.05 to 2.72)	
CPP, but not Looked After	215 (1.3)	95	44.2	2.69 (2.02 to 3.57)	1.37 (1.01 to 1.86)	280 (1.7)	120	42.9	3.09 (2.39 to 3.99)	1.70 (1.30 to 2.23)	475 (2.6)	240	50.5	2.69 (2.22 to 3.26)	1.52 (1.23 to 1.87)	
Not linked to NPD	2720 (16.1)	390	14.3	0.45 (0.40 to 0.51)	– <sup>c</sup>	2360 (14.5)	340	14.4	0.47 (0.41 to 0.54)	– <sup>c</sup>	2870 (15.6)	540	18.8	0.51 (0.46 to 0.57)	– <sup>c</sup>	
Ever recorded as having SEN before 20 weeks of pregnancy																
No	6690 (39.6)	1430	21.4	1 (ref)	1 (ref)	6080 (37.4)	1265	20.8	1 (ref)	1 (ref)	6625 (36.0)	1875	28.3	1 (ref)	1 (ref)	
Yes	7385 (43.7)	2235	30.3	1.63 (1.50 to 1.76)	1.25 (1.14 to 1.37)	7735 (47.5)	2120	27.4	1.49 (1.37 to 1.62)	1.17 (1.07 to 1.29)	8810 (47.8)	3160	35.9	1.46 (1.36 to 1.57)	1.15 (1.06 to 1.25)	
Not linked to NPD	2720 (16.1)	390	14.3	0.54 (0.48 to 0.62)	– <sup>c</sup>	2360 (14.5)	340	14.4	0.54 (0.47 to 0.62)	– <sup>c</sup>	2870 (15.6)	540	18.8	0.56 (0.50 to 0.63)	– <sup>c</sup>	
Linked to NPD but not to NPD census	115 (0.7)	15	13	0.42 (0.23 to 0.76)	– <sup>c</sup>	105 (0.6)	15	14.3	0.51 (0.29 to 0.90)	– <sup>c</sup>	110 (0.6)	10	9.1	0.29 (0.16 to 0.54)	– <sup>c</sup>	

continued

**TABLE 39** Predictors of enrolment in the FNP by English region, among mothers aged 13–19 at LMP, living in a LA with an active FNP site at the time of first antenatal appointment – England, births between April 2010 and March 2017 (continued)

	2013–14					2014–15					2015–16					Adjusted <sup>a</sup> OR (95% CI)
	N eligible mothers	N enrolled in FNP	% enrolled in FNP	Crude OR (95% CI)	Adjusted <sup>a</sup> OR (95% CI)	N eligible mothers	N enrolled in FNP	% enrolled in FNP	Crude OR (95% CI)	Adjusted <sup>a</sup> OR (95% CI)	N eligible mothers	N enrolled in FNP	% enrolled in FNP	Crude OR (95% CI)		
Ever recorded as receiving FSM before 20 weeks of pregnancy																
No	6120 (36.2)	1265	20.7	1 (ref)	1 (ref)	5230 (32.1)	1025	19.6	1 (ref)	1 (ref)	5640 (30.6)	1565	27.7	1 (ref)	1 (ref)	
Yes	7955 (47.0)	2400	30.2	1.75 (1.61 to 1.90)	1.22 (1.11 to 1.34)	8580 (52.7)	2360	27.5	1.54 (1.41 to 1.68)	1.13 (1.02 to 1.25)	9795 (53.2)	3470	35.4	1.45 (1.35 to 1.56)	1.08 (0.99 to 1.18)	
Not linked to NPD	2720 (16.1)	390	14.3	0.58 (0.51 to 0.66)	– <sup>c</sup>	2360 (14.5)	340	14.4	0.56 (0.49 to 0.65)	– <sup>c</sup>	2870 (15.6)	540	18.8	0.57 (0.51 to 0.64)	– <sup>c</sup>	
Linked to NPD but not to NPD census	115 (0.7)	15	13	0.44 (0.24 to 0.81)	– <sup>c</sup>	105 (0.6)	15	14.3	0.53 (0.30 to 0.94)	– <sup>c</sup>	110 (0.6)	10	9.1	0.30 (0.16 to 0.55)	– <sup>c</sup>	
Ever in IDACI bottom decile before 20 weeks of pregnancy																
No	9290 (54.9)	2330	25.1	1 (ref)	1 (ref)	8670 (53.3)	1895	21.9	1 (ref)	1 (ref)	9635 (52.3)	2975	30.9	1 (ref)	1 (ref)	
Yes	4785 (28.3)	1335	27.9	1.22 (1.12 to 1.33)	0.95 (0.86 to 1.05)	5140 (31.6)	1490	29	1.42 (1.30 to 1.56)	1.12 (1.01 to 1.24)	5800 (31.5)	2060	35.5	1.22 (1.13 to 1.32)	0.98 (0.90 to 1.07)	
Not linked to NPD	2720 (16.1)	390	14.3	0.45 (0.39 to 0.51)	– <sup>c</sup>	2360 (14.5)	340	14.4	0.50 (0.43 to 0.57)	– <sup>c</sup>	2870 (15.6)	540	18.8	0.49 (0.44 to 0.54)	– <sup>c</sup>	
Linked to NPD but not to NPD census	115 (0.7)	15	13	0.34 (0.19 to 0.62)	– <sup>c</sup>	105 (0.6)	15	14.3	0.47 (0.26 to 0.83)	– <sup>c</sup>	110 (0.6)	10	9.1	0.26 (0.14 to 0.47)	– <sup>c</sup>	
Educational attainment before 20 weeks of pregnancy																
Did not achieve 5 A*–C GCSEs	10,480 (62.0)	2520	24	1 (ref)	1 (ref)	10,035 (61.7)	2360	23.5	. (.–)	1 (ref)	11,200 (60.8)	3550	31.7	. (.–)	1 (ref)	
Achieved 5 A*–C GCSEs	2575 (15.2)	545	21.2	0.82 (0.74 to 0.92)	1.12 (0.99 to 1.26)	2935 (18.0)	565	19.3	0.76 (0.68 to 0.85)	1.02 (0.90 to 1.15)	3200 (17.4)	810	25.3	0.70 (0.64 to 0.77)	0.99 (0.89 to 1.09)	
Not linked to NPD	2720 (16.1)	390	14.3	0.46 (0.41 to 0.52)	– <sup>c</sup>	2360 (14.5)	340	14.4	0.45 (0.39 to 0.51)	– <sup>c</sup>	2870 (15.6)	540	18.8	0.47 (0.42 to 0.52)	– <sup>c</sup>	

	2013–14					2014–15					2015–16					Adjusted <sup>a</sup> OR (95% CI)
	N eligible mothers	N enrolled in FNP	% enrolled in FNP	Crude OR (95% CI)	Adjusted <sup>a</sup> OR (95% CI)	N eligible mothers	N enrolled in FNP	% enrolled in FNP	Crude OR (95% CI)	Adjusted <sup>a</sup> OR (95% CI)	N eligible mothers	N enrolled in FNP	% enrolled in FNP	Crude OR (95% CI)		
Had not attempted GCSEs	1135 (6.7)	610	53.7	4.05 (3.55 to 4.61)	1.51 (1.28 to 1.79)	950 (5.8)	470	49.5	3.94 (3.40 to 4.56)	1.63 (1.35 to 1.96)	1145 (6.2)	690	60.3	3.71 (3.25 to 4.22)	1.74 (1.48 to 2.06)	
Ever excluded, in PRU, or alternative provision																
No	9680 (57.2)	2245	23.2	1 (ref)	1 (ref)	9465 (58.2)	2090	22.1	1 (ref)	1 (ref)	10,645 (57.8)	3180	29.9	1 (ref)	1 (ref)	
Yes	4510 (26.7)	1430	31.7	1.55 (1.43 to 1.69)	1.07 (0.98 to 1.17)	4455 (27.4)	1310	29.4	1.50 (1.38 to 1.63)	1.04 (0.95 to 1.15)	4900 (26.6)	1865	38.1	1.49 (1.39 to 1.61)	1.02 (0.94 to 1.11)	
Not linked to NPD	2720 (16.1)	390	14.3	0.49 (0.43 to 0.55)	– <sup>c</sup>	2360 (14.5)	340	14.4	0.49 (0.43 to 0.56)	– <sup>c</sup>	2870 (15.6)	540	18.8	0.52 (0.46 to 0.58)	– <sup>c</sup>	
Ever persistently absent in a term (≥ 10% possible sessions)																
No	8765 (51.8)	1575	18	1 (ref)	1 (ref)	8810 (54.1)	1615	18.3	1 (ref)	1 (ref)	9885 (53.7)	2475	25	1 (ref)	1 (ref)	
Yes	5425 (32.1)	2105	38.8	3.13 (2.89 to 3.40)	1.62 (1.47 to 1.80)	5110 (31.4)	1785	34.9	2.67 (2.45 to 2.90)	1.36 (1.23 to 1.52)	5660 (30.7)	2575	45.5	2.79 (2.60 to 3.01)	1.54 (1.40 to 1.68)	
Not linked to NPD	2720 (16.1)	390	14.3	0.68 (0.60 to 0.77)	– <sup>c</sup>	2360 (14.5)	340	14.4	0.63 (0.55 to 0.72)	– <sup>c</sup>	2870 (15.6)	540	18.8	0.67 (0.60 to 0.75)	– <sup>c</sup>	
															continued	

**TABLE 39** Predictors of enrolment in the FNP by English region, among mothers aged 13–19 at LMP, living in a LA with an active FNP site at the time of first antenatal appointment – England, births between April 2010 and March 2017 (continued)

	2016–17				
	N eligible mothers	N enrolled in FNP	% enrolled in FNP	Crude OR (95% CI)	Adjusted <sup>a</sup> OR (95% CI)
<b>Total</b>	<b>15,470</b>	<b>4605</b>	<b>29.8</b>	<b>–</b>	<b>–</b>
Maternal age at birth					
13–15	260 (1.7)	165	63.5	5.31 (4.06 to 6.95)	2.77 (2.02 to 3.81)
16–17	2865 (18.5)	1425	49.7	2.92 (2.66 to 3.21)	2.06 (1.84 to 2.31)
18–19	8750 (56.6)	2375	27.1	1 (ref)	1 (ref)
20 <sup>b</sup>	3590 (23.2)	635	17.7	0.53 (0.48 to 0.58)	0.61 (0.55 to 0.68)
Ethnicity					
White	12,695 (82.1)	3840	30.2	1 (ref)	1 (ref)
South Asian	480 (3.1)	105	21.9	0.61 (0.48 to 0.77)	0.84 (0.65 to 1.08)
Black	500 (3.2)	200	40	1.38 (1.12 to 1.70)	1.58 (1.27 to 1.98)
Mixed/other	870 (5.6)	255	29.3	0.93 (0.79 to 1.10)	1.04 (0.87 to 1.25)
Unknown	920 (5.9)	200	21.7	0.57 (0.48 to 0.67)	0.74 (0.61 to 0.88)
IMD (quintile)					
Least deprived	895 (5.8)	265	29.6	1.00 (0.83 to 1.20)	1.00 (0.82 to 1.21)
2	1315 (8.5)	365	27.8	0.98 (0.83 to 1.14)	0.97 (0.82 to 1.15)
3	2210 (14.3)	630	28.5	1 (ref)	1 (ref)
4	3825 (24.7)	1145	29.9	1.10 (0.98 to 1.25)	1.06 (0.94 to 1.21)
Most deprived	7165 (46.3)	2145	29.9	1.17 (1.04 to 1.32)	1.07 (0.94 to 1.21)
Unknown	60 (0.4)	60	100	–	–
Admission with diagnoses within 2 years before 20 weeks of pregnancy					
Mental health (excluding substance misuse and self-harm)	515 (3.3)	250	48.5	2.50 (2.08 to 3.00)	1.37 (1.08 to 1.74)
Adversity-related	735 (4.8)	380	51.7	2.78 (2.38 to 3.25)	1.27 (1.01 to 1.58)
Any chronic condition	1615 (10.4)	705	43.7	2.05 (1.83 to 2.29)	1.33 (1.13 to 1.57)
A&E attendances	10,130 (65.5)	3325	32.8	1.61 (1.49 to 1.75)	1.36 (1.24 to 1.48)

2016-17					
	N eligible mothers	N enrolled in FNP	% enrolled in FNP	Crude OR (95% CI)	Adjusted <sup>a</sup> OR (95% CI)
Gestational age at antenatal booking appointment					
Before 10 weeks	4490 (29.0)	1295	28.8	1 (ref)	1 (ref)
10-20 weeks	5835 (37.7)	1655	28.4	0.92 (0.83 to 1.00)	0.88 (0.80 to 0.97)
20 weeks or more	760 (4.9)	235	30.9	0.96 (0.80 to 1.14)	0.85 (0.70 to 1.03)
Unknown	4385 (28.3)	1420	32.4	1.15 (1.03 to 1.29)	1.00 (0.89 to 1.13)
Linked to NPD					
Linked to NPD	12,820 (82.9)	4095	31.9	1 (ref)	1 (ref)
Not linked to NPD	2570 (16.6)	490	19.1	0.46 (0.41 to 0.51)	0.87 (0.75 to 1.02)
Linked to NPD but not to NPD census	85 (0.5)	20	23.5	0.52 (0.30 to 0.90)	0.92 (0.51 to 1.64)
Ever had a CPP or was looked after before 20 weeks of pregnancy					
No CPP or Looked After	11,425 (73.9)	3370	29.5	1 (ref)	1 (ref)
Looked After (CPP)	950 (6.1)	475	50	2.52 (2.19 to 2.90)	1.76 (1.51 to 2.06)
CPP, but not Looked After	530 (3.4)	270	50.9	2.65 (2.20 to 3.18)	1.45 (1.19 to 1.77)
Not linked to NPD	2570 (16.6)	490	19.1	0.52 (0.46 to 0.58)	- <sup>c</sup>
Ever recorded as having SEN before 20 weeks of pregnancy					
No	5395 (34.9)	1435	26.6	1 (ref)	1 (ref)
Yes	7425 (48.0)	2665	35.9	1.61 (1.49 to 1.75)	1.29 (1.18 to 1.42)
Not linked to NPD	2570 (16.6)	490	19.1	0.61 (0.54 to 0.69)	- <sup>c</sup>
Linked to NPD but not to NPD census	85 (0.5)	20	23.5	0.70 (0.40 to 1.22)	- <sup>c</sup>
Ever recorded as receiving FSM before 20 weeks of pregnancy					
No	4500 (29.1)	1200	26.7	1 (ref)	1 (ref)
Yes	8320 (53.8)	2895	34.8	1.50 (1.38 to 1.63)	1.10 (1.00 to 1.21)
Not linked to NPD	2570 (16.6)	490	19.1	0.60 (0.53 to 0.68)	- <sup>c</sup>
Linked to NPD but not to NPD census	85 (0.5)	20	23.5	0.69 (0.39 to 1.21)	- <sup>c</sup>

continued

**TABLE 39** Predictors of enrolment in the FNP by English region, among mothers aged 13–19 at LMP, living in a LA with an active FNP site at the time of first antenatal appointment – England, births between April 2010 and March 2017 (continued)

	2016–17				
	N eligible mothers	N enrolled in FNP	% enrolled in FNP	Crude OR (95% CI)	Adjusted <sup>a</sup> OR (95% CI)
Ever in IDACI bottom decile before 20 weeks of pregnancy					
No	7900 (51.1)	2370	30	1 (ref)	1 (ref)
Yes	4920 (31.8)	1730	35.2	1.34 (1.23 to 1.46)	1.03 (0.93 to 1.14)
Not linked to NPD	2570 (16.6)	490	19.1	0.52 (0.46 to 0.58)	– <sup>c</sup>
Linked to NPD but not to NPD census	85 (0.5)	20	23.5	0.60 (0.35 to 1.06)	– <sup>c</sup>
Educational attainment before 20 weeks of pregnancy					
Did not achieve 5 A*–C GCSEs	9455 (61.1)	3025	32	. (.–.)	1 (ref)
Achieved 5 A*–C GCSEs	2680 (17.3)	610	22.8	0.60 (0.54 to 0.66)	0.91 (0.81 to 1.02)
Not linked to NPD	2570 (16.6)	490	19.1	0.46 (0.41 to 0.51)	– <sup>c</sup>
Had not attempted GCSEs	765 (4.9)	480	62.7	4.11 (3.50 to 4.83)	1.72 (1.41 to 2.09)
Ever excluded, in PRU, or alternative provision					
No	8705 (56.3)	2485	28.5	1 (ref)	1 (ref)
Yes	4195 (27.1)	1630	38.9	1.62 (1.49 to 1.75)	1.06 (0.97 to 1.17)
Not linked to NPD	2570 (16.6)	490	19.1	0.54 (0.48 to 0.61)	– <sup>c</sup>
Ever persistently absent in a term (≥ 10% possible sessions)					
No	8480 (54.8)	2095	24.7	1 (ref)	1 (ref)
Yes	4420 (28.6)	2020	45.7	2.86 (2.63 to 3.10)	1.44 (1.30 to 1.60)
Not linked to NPD	2570 (16.6)	490	19.1	0.67 (0.60 to 0.76)	– <sup>c</sup>

a Adjusted models included all variables in the table as covariates.

b Includes only mothers aged 19 at LMP.

c Estimates omitted due to multicollinearity.

#### Note

Numbers have been rounded to the nearest 5 and cell sizes < 10 have been suppressed, in accordance with NHS Digital's and DfE's statistical disclosure rules for subnational analyses.

**TABLE 40** Predictors of enrolment in the FNP by financial year, among mothers aged 13–19 at LMP, living in a LA with an active FNP site at the time of first antenatal appointment – England, births between April 2010 and March 2017

	2010–1					2011–2					2012–3				
	N eligible mothers	N enrolled in FNP	% enrolled in FNP	Crude OR (95% CI)	Adjusted <sup>a</sup> OR (95% CI)	N eligible mothers	N enrolled in FNP	% enrolled in FNP	Crude OR (95% CI)	Adjusted <sup>a</sup> OR (95% CI)	N eligible mothers	N enrolled in FNP	% enrolled in FNP	Crude OR (95% CI)	Adjusted <sup>a</sup> OR (95% CI)
<b>Total</b>	<b>13,360</b>	<b>2770</b>	<b>20.7</b>	–	–	<b>13,820</b>	<b>1605</b>	<b>11.6</b>	–	–	<b>16,225</b>	<b>3305</b>	<b>20.4</b>	–	–
Maternal age at birth															
13–15	270 (2.0)	115	42.6	3.63 (2.78 to 4.76)	2.23 (1.61 to 3.09)	320 (2.3)	110	34.4	6.46 (4.85 to 8.59)	2.92 (2.04 to 4.16)	390 (2.4)	205	52.6	6.17 (4.96 to 7.68)	3.55 (2.70 to 4.67)
16–17	2900 (21.7)	920	31.7	2.01 (1.81 to 2.23)	1.52 (1.34 to 1.73)	2960 (21.4)	655	22.1	3.24 (2.85 to 3.69)	2.06 (1.76 to 2.42)	3450 (21.3)	1290	37.4	3.19 (2.90 to 3.50)	2.21 (1.98 to 2.48)
18–19	7345 (55.0)	1455	19.8	1 (ref)	1 (ref)	7500 (54.3)	705	9.4	1 (ref)	1 (ref)	8875 (54.7)	1560	17.6	1 (ref)	1 (ref)
20 <sup>b</sup>	2845 (21.3)	280	9.8	0.42 (0.37 to 0.49)	0.49 (0.42 to 0.56)	3040 (22.0)	135	4.4	0.42 (0.34 to 0.51)	0.52 (0.42 to 0.64)	3510 (21.6)	255	7.3	0.35 (0.31 to 0.41)	0.44 (0.38 to 0.51)
Ethnicity															
White	11,485 (86.0)	2330	20.3	1 (ref)	1 (ref)	11,880 (86.0)	1305	11	1 (ref)	1 (ref)	14,065 (86.7)	2890	20.5	1 (ref)	1 (ref)
South Asian	365 (2.7)	50	13.7	0.42 (0.30 to 0.58)	0.58 (0.41 to 0.83)	315 (2.3)	40	12.7	0.69 (0.47 to 1.02)	0.81 (0.53 to 1.26)	415 (2.6)	65	15.7	0.57 (0.42 to 0.77)	0.84 (0.60 to 1.17)
Black	585 (4.4)	190	32.5	1.32 (1.06 to 1.64)	1.47 (1.17 to 1.85)	625 (4.5)	125	20	1.24 (0.97 to 1.58)	1.29 (0.98 to 1.68)	570 (3.5)	130	22.8	1.10 (0.87 to 1.40)	1.31 (1.01 to 1.70)
Mixed/other	640 (4.8)	150	23.4	0.91 (0.73 to 1.12)	0.98 (0.79 to 1.23)	695 (5.0)	95	13.7	0.90 (0.70 to 1.16)	0.95 (0.73 to 1.25)	745 (4.6)	160	21.5	1.05 (0.86 to 1.27)	1.09 (0.88 to 1.35)
Unknown	280 (2.1)	50	17.9	0.75 (0.55 to 1.04)	0.90 (0.64 to 1.27)	310 (2.2)	35	11.3	0.87 (0.60 to 1.27)	1.06 (0.71 to 1.60)	430 (2.7)	60	14	0.63 (0.48 to 0.84)	0.74 (0.54 to 1.00)
IMD (quintile)															
Least deprived	560 (4.2)	95	17	0.76 (0.58 to 1.00)	0.78 (0.59 to 1.03)	555 (4.0)	40	7.2	0.52 (0.36 to 0.77)	0.52 (0.35 to 0.79)	770 (4.7)	110	14.3	0.83 (0.65 to 1.05)	0.90 (0.70 to 1.16)
2	875 (6.5)	155	17.7	0.95 (0.75 to 1.19)	0.94 (0.74 to 1.19)	950 (6.9)	95	10	0.97 (0.74 to 1.28)	0.95 (0.71 to 1.28)	1310 (8.1)	230	17.6	1.01 (0.84 to 1.22)	1.09 (0.89 to 1.33)

continued



**TABLE 40** Predictors of enrolment in the FNP by financial year, among mothers aged 13–19 at LMP, living in a LA with an active FNP site at the time of first antenatal appointment – England, births between April 2010 and March 2017 (continued)

	2010–1					2011–2					2012–3				
	N eligible mothers	N enrolled in FNP	% enrolled in FNP	Crude OR (95% CI)	Adjusted <sup>a</sup> OR (95% CI)	N eligible mothers	N enrolled in FNP	% enrolled in FNP	Crude OR (95% CI)	Adjusted <sup>a</sup> OR (95% CI)	N eligible mothers	N enrolled in FNP	% enrolled in FNP	Crude OR (95% CI)	Adjusted <sup>a</sup> OR (95% CI)
3	1570 (11.8)	290	18.5	1 (ref)	1 (ref)	1770 (12.8)	195	11	1 (ref)	1 (ref)	2195 (13.5)	390	17.8	1 (ref)	1 (ref)
4	3260 (24.4)	695	21.3	1.27 (1.08 to 1.50)	1.19 (1.01 to 1.41)	3505 (25.4)	425	12.1	1.21 (0.99 to 1.47)	1.10 (0.89 to 1.35)	4010 (24.7)	825	20.6	1.27 (1.10 to 1.46)	1.24 (1.07 to 1.45)
Most deprived	7085 (53.0)	1520	21.5	1.45 (1.24 to 1.69)	1.33 (1.13 to 1.56)	7035 (50.9)	840	11.9	1.17 (0.97 to 1.42)	0.97 (0.79 to 1.19)	7930 (48.9)	1740	21.9	1.49 (1.30 to 1.70)	1.36 (1.17 to 1.58)
Unknown	10 (0.1)	10	100	–	–	–	–	–	–	–	10 (0.1)	10	100	–	–
Admission with diagnoses within 2 years before 20 weeks of pregnancy															
Mental health (excluding substance misuse and self-harm)	155 (1.2)	50	32.3	1.91 (1.33 to 2.74)	1.35 (0.88 to 2.06)	210 (1.5)	35	16.7	1.74 (1.17 to 2.60)	0.98 (0.60 to 1.58)	295 (1.8)	90	30.5	1.71 (1.31 to 2.22)	1.06 (0.76 to 1.47)
Adversity-related	485 (3.6)	150	30.9	1.90 (1.54 to 2.34)	0.97 (0.71 to 1.31)	515 (3.7)	105	20.4	2.46 (1.93 to 3.14)	1.54 (1.07 to 2.22)	620 (3.8)	220	35.5	2.42 (2.02 to 2.89)	1.30 (1.00 to 1.70)
Any chronic condition	930 (7.0)	265	28.5	1.64 (1.40 to 1.92)	1.25 (0.99 to 1.58)	1090 (7.9)	180	16.5	1.67 (1.39 to 2.01)	1.13 (0.85 to 1.50)	1350 (8.3)	385	28.5	1.70 (1.49 to 1.94)	1.18 (0.97 to 1.45)
A&E attendances	7600 (56.9)	1775	23.4	1.50 (1.37 to 1.64)	1.37 (1.24 to 1.51)	8340 (60.3)	1075	12.9	1.34 (1.19 to 1.51)	1.20 (1.05 to 1.37)	10,005 (61.7)	2275	22.7	1.54 (1.42 to 1.68)	1.38 (1.25 to 1.52)
Gestational age at antenatal booking appointment															
Before 10 weeks	2985 (22.3)	615	20.6	1 (ref)	1 (ref)	3585 (25.9)	390	10.9	1 (ref)	1 (ref)	4555 (28.1)	905	19.9	1 (ref)	1 (ref)
10–20 weeks	5325 (39.9)	1100	20.7	0.95 (0.84 to 1.07)	0.94 (0.83 to 1.07)	5055 (36.6)	590	11.7	1.06 (0.91 to 1.24)	1.04 (0.89 to 1.23)	6150 (37.9)	1290	21	0.96 (0.87 to 1.06)	0.88 (0.78 to 0.98)
20 weeks or more	910 (6.8)	170	18.7	0.75 (0.61 to 0.93)	0.65 (0.53 to 0.81)	815 (5.9)	145	17.8	1.48 (1.17 to 1.88)	1.10 (0.85 to 1.42)	920 (5.7)	200	21.7	0.93 (0.78 to 1.12)	0.68 (0.56 to 0.84)

	2010-1					2011-2					2012-3				
	N eligible mothers	N enrolled in FNP	% enrolled in FNP	Crude OR (95% CI)	Adjusted <sup>a</sup> OR (95% CI)	N eligible mothers	N enrolled in FNP	% enrolled in FNP	Crude OR (95% CI)	Adjusted <sup>a</sup> OR (95% CI)	N eligible mothers	N enrolled in FNP	% enrolled in FNP	Crude OR (95% CI)	Adjusted <sup>a</sup> OR (95% CI)
Unknown	4135 (31.0)	880	21.3	0.87 (0.75 to 1.01)	0.81 (0.69 to 0.95)	4365 (31.6)	475	10.9	1.02 (0.85 to 1.23)	0.94 (0.77 to 1.14)	4600 (28.4)	910	19.8	1.01 (0.89 to 1.15)	0.82 (0.71 to 0.94)
Linked to NPD															
Linked to NPD	10,995 (82.3)	2400	21.8	1 (ref)	1 (ref)	11,495 (83.2)	1410	12.3	1 (ref)	1 (ref)	13,595 (83.8)	2985	22	1 (ref)	1 (ref)
Not linked to NPD	2175 (16.3)	330	15.2	0.52 (0.45 to 0.59)	0.79 (0.67 to 0.94)	2190 (15.8)	175	8	0.44 (0.37 to 0.53)	0.88 (0.69 to 1.11)	2515 (15.5)	300	11.9	0.44 (0.38 to 0.50)	0.80 (0.67 to 0.96)
Linked to NPD but not to NPD census	190 (1.4)	35	18.4	0.71 (0.48 to 1.04)	1.11 (0.74 to 1.65)	135 (1.0)	15	11.1	0.59 (0.32 to 1.07)	1.04 (0.55 to 1.97)	120 (0.7)	20	16.7	0.59 (0.35 to 0.99)	0.96 (0.55 to 1.67)
Ever had a CPP or was looked after before 20 weeks of pregnancy															
No CPP or Looked After	10,690 (80.0)	2260	21.1	1 (ref)	1 (ref)	11,030 (79.8)	1260	11.4	1 (ref)	1 (ref)	12,865 (79.3)	2660	20.7	1 (ref)	1 (ref)
Looked After (CPP)	480 (3.6)	175	36.5	2.00 (1.63 to 2.46)	1.47 (1.18 to 1.83)	545 (3.9)	150	27.5	3.07 (2.46 to 3.84)	2.33 (1.83 to 2.98)	730 (4.5)	295	40.4	2.95 (2.51 to 3.48)	2.24 (1.87 to 2.68)
CPP, but not Looked After	10 (0.1)	-	-	2.72 (0.79 to 9.30)	1.40 (0.39 to 5.04)	50 (0.4)	15	30	3.02 (1.58 to 5.80)	1.18 (0.59 to 2.33)	120 (0.7)	50	41.7	3.18 (2.17 to 4.66)	1.42 (0.94 to 2.14)
Not linked to NPD	2175 (16.3)	330	15.2	0.55 (0.48 to 0.62)	- <sup>c</sup>	2190 (15.8)	175	8	0.48 (0.40 to 0.58)	- <sup>c</sup>	2515 (15.5)	300	11.9	0.48 (0.42 to 0.55)	- <sup>c</sup>
Ever recorded as having SEN before 20 weeks of pregnancy															
No	6955 (52.1)	1320	19	1 (ref)	1 (ref)	6555 (47.4)	665	10.1	1 (ref)	1 (ref)	6955 (42.9)	1200	17.3	1 (ref)	1 (ref)
Yes	4040 (30.2)	1085	26.9	1.55 (1.41 to 1.71)	1.14 (1.03 to 1.27)	4935 (35.7)	745	15.1	1.66 (1.47 to 1.87)	1.07 (0.93 to 1.23)	6640 (40.9)	1785	26.9	1.76 (1.61 to 1.92)	1.25 (1.13 to 1.38)
Not linked to NPD	2175 (16.3)	330	15.2	0.63 (0.54 to 0.72)	- <sup>c</sup>	2190 (15.8)	175	8	0.56 (0.46 to 0.68)	- <sup>c</sup>	2515 (15.5)	300	11.9	0.59 (0.51 to 0.69)	- <sup>c</sup>

continued

**TABLE 40** Predictors of enrolment in the FNP by financial year, among mothers aged 13–19 at LMP, living in a LA with an active FNP site at the time of first antenatal appointment – England, births between April 2010 and March 2017 (continued)

	2010–1					2011–2					2012–3				
	N eligible mothers	N enrolled in FNP	% enrolled in FNP	Crude OR (95% CI)	Adjusted <sup>a</sup> OR (95% CI)	N eligible mothers	N enrolled in FNP	% enrolled in FNP	Crude OR (95% CI)	Adjusted <sup>a</sup> OR (95% CI)	N eligible mothers	N enrolled in FNP	% enrolled in FNP	Crude OR (95% CI)	Adjusted <sup>a</sup> OR (95% CI)
Linked to NPD but not to NPD census	190 (1.4)	35	18.4	0.85 (0.58 to 1.25)	– <sup>c</sup>	135 (1.0)	15	11.1	0.75 (0.41 to 1.37)	– <sup>c</sup>	120 (0.7)	20	16.7	0.80 (0.47 to 1.35)	– <sup>c</sup>
Ever recorded as receiving FSM before 20 weeks of pregnancy															
No	6730 (50.4)	1275	18.9	1 (ref)	1 (ref)	6385 (46.2)	550	8.6	1 (ref)	1 (ref)	6835 (42.1)	1165	17	1 (ref)	1 (ref)
Yes	4265 (31.9)	1125	26.4	1.43 (1.30 to 1.58)	1.01 (0.91 to 1.13)	5105 (36.9)	860	16.8	2.18 (1.92 to 2.48)	1.34 (1.16 to 1.55)	6760 (41.7)	1820	26.9	1.85 (1.70 to 2.02)	1.11 (1.00 to 1.23)
Not linked to NPD	2175 (16.3)	330	15.2	0.61 (0.53 to 0.70)	– <sup>c</sup>	2190 (15.8)	175	8	0.68 (0.55 to 0.82)	– <sup>c</sup>	2515 (15.5)	300	11.9	0.61 (0.53 to 0.71)	– <sup>c</sup>
Linked to NPD but not to NPD census	190 (1.4)	35	18.4	0.83 (0.56 to 1.22)	– <sup>c</sup>	135 (1.0)	15	11.1	0.87 (0.47 to 1.59)	– <sup>c</sup>	120 (0.7)	20	16.7	0.82 (0.48 to 1.39)	– <sup>c</sup>
Ever in IDACI bottom decile before 20 weeks of pregnancy															
No	7475 (56.0)	1530	20.5	1 (ref)	1 (ref)	7700 (55.7)	820	10.6	1 (ref)	1 (ref)	9075 (55.9)	1845	20.3	1 (ref)	1 (ref)
Yes	3520 (26.3)	870	24.7	1.31 (1.17 to 1.46)	1.05 (0.93 to 1.18)	3795 (27.5)	595	15.7	1.41 (1.23 to 1.62)	1.15 (0.99 to 1.34)	4520 (27.9)	1145	25.3	1.33 (1.21 to 1.46)	0.99 (0.89 to 1.11)
Not linked to NPD	2175 (16.3)	330	15.2	0.58 (0.50 to 0.67)	– <sup>c</sup>	2190 (15.8)	175	8	0.52 (0.43 to 0.63)	– <sup>c</sup>	2515 (15.5)	300	11.9	0.49 (0.42 to 0.56)	– <sup>c</sup>
Linked to NPD but not to NPD census	190 (1.4)	35	18.4	0.78 (0.53 to 1.15)	– <sup>c</sup>	135 (1.0)	15	11.1	0.67 (0.36 to 1.22)	– <sup>c</sup>	120 (0.7)	20	16.7	0.65 (0.39 to 1.10)	– <sup>c</sup>

	2010–1					2011–2					2012–3				
	N eligible mothers	N enrolled in FNP	% enrolled in FNP	Crude OR (95% CI)	Adjusted <sup>a</sup> OR (95% CI)	N eligible mothers	N enrolled in FNP	% enrolled in FNP	Crude OR (95% CI)	Adjusted <sup>a</sup> OR (95% CI)	N eligible mothers	N enrolled in FNP	% enrolled in FNP	Crude OR (95% CI)	Adjusted <sup>a</sup> OR (95% CI)
<b>Educational attainment before 20 weeks of pregnancy</b>															
Did not achieve 5 A*–C GCSEs	8845 (66.2)	1830	20.7	1 (ref)	1 (ref)	9015 (65.2)	985	10.9	1 (ref)	1 (ref)	10,285 (63.4)	2090	20.3	1 (ref)	1 (ref)
Achieved 5 A*–C GCSEs	1470 (11.0)	255	17.3	0.84 (0.72 to 0.97)	1.06 (0.90 to 1.24)	1730 (12.5)	150	8.7	0.78 (0.64 to 0.95)	0.99 (0.80 to 1.22)	2360 (14.5)	380	16.1	0.75 (0.66 to 0.85)	1.00 (0.87 to 1.15)
Not linked to NPD	2175 (16.3)	330	15.2	0.56 (0.49 to 0.65)	– <sup>c</sup>	2190 (15.8)	175	8	0.51 (0.42 to 0.61)	– <sup>c</sup>	2515 (15.5)	300	11.9	0.48 (0.42 to 0.56)	– <sup>c</sup>
Had not attempted GCSEs	870 (6.5)	350	40.2	2.87 (2.46 to 3.36)	1.43 (1.18 to 1.74)	885 (6.4)	290	32.8	4.89 (4.09 to 5.86)	1.70 (1.35 to 2.13)	1065 (6.6)	535	50.2	4.50 (3.92 to 5.16)	1.53 (1.28 to 1.82)
<b>Ever excluded, in PRU, or alternative provision</b>															
No	8625 (64.6)	1705	19.8	1 (ref)	1 (ref)	8450 (61.1)	925	10.9	1 (ref)	1 (ref)	9655 (59.5)	1905	19.7	1 (ref)	1 (ref)
Yes	2560 (19.2)	735	28.7	1.63 (1.46 to 1.81)	1.06 (0.95 to 1.20)	3180 (23.0)	505	15.9	1.55 (1.36 to 1.76)	0.94 (0.81 to 1.08)	4060 (25.0)	1100	27.1	1.57 (1.43 to 1.71)	1.01 (0.91 to 1.12)
Not linked to NPD	2175 (16.3)	330	15.2	0.59 (0.52 to 0.68)	– <sup>c</sup>	2190 (15.8)	175	8	0.51 (0.42 to 0.61)	– <sup>c</sup>	2515 (15.5)	300	11.9	0.51 (0.44 to 0.58)	– <sup>c</sup>
<b>Ever persistently absent in a term (≥ 10% possible sessions)</b>															
No	6520 (48.8)	1050	16.1	1 (ref)	1 (ref)	6990 (50.6)	525	7.5	1 (ref)	1 (ref)	8290 (51.1)	1130	13.6	1 (ref)	1 (ref)
Yes	4665 (34.9)	1390	29.8	2.36 (2.14 to 2.60)	1.38 (1.22 to 1.55)	4635 (33.5)	900	19.4	3.62 (3.19 to 4.11)	1.67 (1.42 to 1.96)	5420 (33.4)	1875	34.6	3.73 (3.41 to 4.08)	1.74 (1.56 to 1.94)
Not linked to NPD	2175 (16.3)	330	15.2	0.77 (0.67 to 0.89)	– <sup>c</sup>	2190 (15.8)	175	8	0.80 (0.66 to 0.98)	– <sup>c</sup>	2515 (15.5)	300	11.9	0.79 (0.68 to 0.91)	– <sup>c</sup>

continued

**TABLE 40** Predictors of enrolment in the FNP by financial year, among mothers aged 13–19 at LMP, living in a LA with an active FNP site at the time of first antenatal appointment – England, births between April 2010 and March 2017 (continued)

	London					South-East					South-West				
	N eligible mothers	N enrolled in FNP	% enrolled in FNP	Crude OR (95% CI)	Adjusted <sup>a</sup> OR (95% CI)	N eligible mothers	N enrolled in FNP	% enrolled in FNP	Crude OR (95% CI)	Adjusted <sup>a</sup> OR (95% CI)	N eligible mothers	N enrolled in FNP	% enrolled in FNP	Crude OR (95% CI)	Adjusted <sup>a</sup> OR (95% CI)
<b>Total</b>	<b>12,010</b>	<b>3600</b>	<b>30</b>	–	–	<b>13,625</b>	<b>3730</b>	<b>27.4</b>	–	–	<b>5440</b>	<b>1395</b>	<b>25.6</b>	–	–
<b>Maternal age at birth</b>															
13–15	235 (2.0)	135	57.4	4.02 (3.07 to 5.27)	2.58 (1.86 to 3.58)	275 (2.0)	170	61.8	5.99 (4.62 to 7.76)	3.48 (2.55 to 4.75)	80 (1.5)	50	62.5	7.20 (4.44 to 11.68)	3.85 (2.17 to 6.81)
16–17	2205 (18.4)	980	44.4	2.07 (1.87 to 2.29)	1.60 (1.42 to 1.81)	2690 (19.7)	1230	45.7	2.77 (2.52 to 3.05)	1.93 (1.72 to 2.17)	1000 (18.4)	435	43.5	2.61 (2.24 to 3.05)	1.76 (1.45 to 2.14)
18–19	6680 (55.6)	1905	28.5	1 (ref)	1 (ref)	7750 (56.9)	1930	24.9	1 (ref)	1 (ref)	3050 (56.1)	735	24.1	1 (ref)	1 (ref)
20 <sup>b</sup>	2890 (24.1)	585	20.2	0.62 (0.56 to 0.69)	0.68 (0.61 to 0.76)	2910 (21.4)	395	13.6	0.45 (0.40 to 0.50)	0.54 (0.47 to 0.61)	1315 (24.2)	175	13.3	0.45 (0.38 to 0.55)	0.52 (0.43 to 0.64)
<b>Ethnicity</b>															
White	6025 (50.2)	1690	28	1 (ref)	1 (ref)	11,895 (87.3)	3290	27.7	1 (ref)	1 (ref)	5125 (94.2)	1330	26	1 (ref)	1 (ref)
South Asian	1000 (8.3)	265	26.5	0.80 (0.68 to 0.94)	0.98 (0.83 to 1.17)	235 (1.7)	35	14.9	0.42 (0.29 to 0.60)	0.65 (0.44 to 0.95)	25 (0.5)	–	–	0.54 (0.20 to 1.47)	1.11 (0.38 to 3.19)
Black	2525 (21.0)	885	35	1.54 (1.38 to 1.71)	1.61 (1.44 to 1.80)	170 (1.2)	55	32.4	1.27 (0.91 to 1.78)	1.47 (1.02 to 2.13)	45 (0.8)	–	–	0.45 (0.20 to 1.02)	0.54 (0.22 to 1.30)
Mixed/ other	1880 (15.7)	605	32.2	1.27 (1.13 to 1.43)	1.36 (1.20 to 1.53)	405 (3.0)	110	27.2	0.92 (0.73 to 1.15)	0.99 (0.77 to 1.26)	110 (2.0)	25	22.7	0.74 (0.47 to 1.16)	0.84 (0.51 to 1.37)
Unknown	580 (4.8)	160	27.6	0.99 (0.81 to 1.20)	1.43 (1.16 to 1.76)	920 (6.8)	240	26.1	0.85 (0.72 to 1.00)	0.96 (0.81 to 1.14)	140 (2.6)	25	17.9	0.49 (0.32 to 0.76)	0.60 (0.38 to 0.97)
<b>IMD (quintile)</b>															
Least deprived	105 (0.9)	45	42.9	1.79 (1.18 to 2.71)	1.68 (1.08 to 2.63)	1785 (13.1)	410	23	0.73 (0.63 to 0.84)	0.76 (0.65 to 0.89)	380 (7.0)	100	26.3	0.67 (0.50 to 0.89)	0.72 (0.53 to 0.98)
2	395 (3.3)	135	34.2	1.13 (0.88 to 1.45)	1.17 (0.90 to 1.52)	1865 (13.7)	445	23.9	0.81 (0.71 to 0.93)	0.89 (0.77 to 1.03)	615 (11.3)	170	27.6	0.88 (0.69 to 1.11)	0.87 (0.67 to 1.12)

	London					South-East					South-West				
	N eligible mothers	N enrolled in FNP	% enrolled in FNP	Crude OR (95% CI)	Adjusted <sup>a</sup> OR (95% CI)	N eligible mothers	N enrolled in FNP	% enrolled in FNP	Crude OR (95% CI)	Adjusted <sup>a</sup> OR (95% CI)	N eligible mothers	N enrolled in FNP	% enrolled in FNP	Crude OR (95% CI)	Adjusted <sup>a</sup> OR (95% CI)
3	1305 (10.9)	390	29.9	1 (ref)	1 (ref)	2795 (20.5)	770	27.5	1 (ref)	1 (ref)	1100 (20.2)	275	25	1 (ref)	1 (ref)
4	4155 (34.6)	1195	28.8	1.00 (0.87 to 1.16)	0.95 (0.81 to 1.10)	3770 (27.7)	1080	28.6	1.09 (0.97 to 1.22)	1.03 (0.91 to 1.16)	1625 (29.9)	385	23.7	1.01 (0.84 to 1.21)	0.92 (0.76 to 1.12)
Most deprived	5990 (49.9)	1775	29.6	1.03 (0.90 to 1.19)	0.96 (0.82 to 1.11)	3395 (24.9)	1020	30	1.25 (1.11 to 1.41)	1.17 (1.03 to 1.34)	1715 (31.5)	460	26.8	1.19 (0.99 to 1.43)	1.00 (0.82 to 1.23)
Unknown	65 (0.5)	65	100	-	-	10 (0.1)	10	100	-	-	-	-	-	-	-
<b>Admission with diagnoses within 2 years before 20 weeks of pregnancy</b>															
Mental health (excluding substance misuse and self-harm)	175 (1.5)	90	51.4	2.61 (1.92 to 3.54)	1.33 (0.92 to 1.93)	330 (2.4)	140	42.4	2.21 (1.76 to 2.77)	1.40 (1.05 to 1.87)	175 (3.2)	70	40	2.02 (1.48 to 2.77)	1.43 (0.94 to 2.17)
Adversity-related	355 (3.0)	190	53.5	2.81 (2.26 to 3.48)	1.33 (0.99 to 1.79)	500 (3.7)	220	44	2.32 (1.93 to 2.80)	1.14 (0.88 to 1.49)	255 (4.7)	105	41.2	2.22 (1.71 to 2.89)	1.24 (0.84 to 1.83)
Any chronic condition	755 (6.3)	345	45.7	2.13 (1.83 to 2.48)	1.38 (1.12 to 1.71)	1165 (8.6)	440	37.8	1.77 (1.56 to 2.02)	1.26 (1.04 to 1.53)	555 (10.2)	190	34.2	1.64 (1.35 to 1.99)	1.10 (0.81 to 1.49)
A&E attendances	7795 (64.9)	2665	34.2	1.85 (1.69 to 2.02)	1.53 (1.39 to 1.68)	8390 (61.6)	2475	29.5	1.39 (1.28 to 1.51)	1.24 (1.13 to 1.36)	3110 (57.2)	885	28.5	1.42 (1.25 to 1.62)	1.26 (1.09 to 1.46)
<b>Gestational age at antenatal booking appointment</b>															
Before 10 weeks	1725 (14.4)	515	29.9	1 (ref)	1 (ref)	3280 (24.1)	930	28.4	1 (ref)	1 (ref)	2500 (46.0)	645	25.8	1 (ref)	1 (ref)
10–20 weeks	5710 (47.5)	1730	30.3	1.04 (0.92 to 1.17)	1.02 (0.90 to 1.16)	5430 (39.9)	1540	28.4	0.95 (0.86 to 1.05)	0.91 (0.81 to 1.01)	1995 (36.7)	505	25.3	0.87 (0.76 to 1.00)	0.79 (0.68 to 0.92)
20 weeks or more	1060 (8.8)	285	26.9	0.90 (0.75 to 1.07)	0.82 (0.68 to 0.99)	610 (4.5)	150	24.6	0.72 (0.59 to 0.89)	0.64 (0.51 to 0.80)	240 (4.4)	55	22.9	0.76 (0.55 to 1.05)	0.64 (0.45 to 0.90)

continued

**TABLE 40** Predictors of enrolment in the FNP by financial year, among mothers aged 13–19 at LMP, living in a LA with an active FNP site at the time of first antenatal appointment – England, births between April 2010 and March 2017 (continued)

	London					South-East					South-West				
	N eligible mothers	N enrolled in FNP	% enrolled in FNP	Crude OR (95% CI)	Adjusted <sup>a</sup> OR (95% CI)	N eligible mothers	N enrolled in FNP	% enrolled in FNP	Crude OR (95% CI)	Adjusted <sup>a</sup> OR (95% CI)	N eligible mothers	N enrolled in FNP	% enrolled in FNP	Crude OR (95% CI)	Adjusted <sup>a</sup> OR (95% CI)
Unknown	3515 (29.3)	1075	30.6	1.03 (0.90 to 1.17)	0.89 (0.77 to 1.02)	4300 (31.6)	1110	25.8	0.84 (0.75 to 0.93)	0.71 (0.63 to 0.81)	700 (12.9)	195	27.9	0.84 (0.69 to 1.04)	0.74 (0.60 to 0.93)
Linked to NPD															
Linked to NPD	7680 (63.9)	2690	35	1 (ref)	1 (ref)	11,810 (86.7)	3445	29.2	1 (ref)	1 (ref)	4795 (88.1)	1295	27	1 (ref)	1 (ref)
Not linked to NPD	4140 (34.5)	865	20.9	0.47 (0.43 to 0.51)	0.80 (0.68 to 0.93)	1705 (12.5)	260	15.2	0.43 (0.37 to 0.49)	0.79 (0.66 to 0.94)	600 (11.0)	95	15.8	0.44 (0.35 to 0.55)	0.84 (0.64 to 1.11)
Linked to NPD but not to NPD census	190 (1.6)	45	23.7	0.56 (0.40 to 0.79)	0.94 (0.65 to 1.35)	110 (0.8)	20	18.2	0.55 (0.34 to 0.88)	0.89 (0.54 to 1.47)	45 (0.8)	-	-	0.44 (0.20 to 1.00)	0.80 (0.34 to 1.88)
Ever had a CPP or was looked after before 20 weeks of pregnancy															
No CPP or Looked After	6985 (58.2)	2285	32.7	1 (ref)	1 (ref)	10,980 (80.6)	3005	27.4	1 (ref)	1 (ref)	4455 (81.9)	1120	25.1	1 (ref)	1 (ref)
Looked After (CPP)	760 (6.3)	380	50	2.15 (1.85 to 2.51)	1.52 (1.29 to 1.80)	705 (5.2)	330	46.8	2.46 (2.10 to 2.88)	1.77 (1.48 to 2.10)	315 (5.8)	155	49.2	3.08 (2.43 to 3.90)	2.38 (1.83 to 3.10)
CPP, but not Looked After	125 (1.0)	70	56	2.56 (1.78 to 3.68)	1.60 (1.08 to 2.35)	230 (1.7)	130	56.5	3.54 (2.69 to 4.66)	1.76 (1.31 to 2.36)	70 (1.3)	30	42.9	2.31 (1.42 to 3.74)	1.09 (0.65 to 1.82)
Not linked to NPD	4140 (34.5)	865	20.9	0.52 (0.48 to 0.58)	- <sup>c</sup>	1705 (12.5)	260	15.2	0.47 (0.41 to 0.54)	- <sup>c</sup>	600 (11.0)	95	15.8	0.49 (0.38 to 0.62)	- <sup>c</sup>
Ever recorded as having SEN before 20 weeks of pregnancy															
No	3020 (25.1)	910	30.1	1 (ref)	1 (ref)	5160 (37.9)	1235	23.9	1 (ref)	1 (ref)	2575 (47.3)	545	21.2	1 (ref)	1 (ref)
Yes	4660 (38.8)	1780	38.2	1.45 (1.31 to 1.60)	1.19 (1.07 to 1.33)	6650 (48.8)	2210	33.2	1.65 (1.52 to 1.80)	1.20 (1.09 to 1.33)	2220 (40.8)	750	33.8	1.87 (1.63 to 2.13)	1.42 (1.22 to 1.66)

	London					South-East					South-West				
	N eligible mothers	N enrolled in FNP	% enrolled in FNP	Crude OR (95% CI)	Adjusted <sup>a</sup> OR (95% CI)	N eligible mothers	N enrolled in FNP	% enrolled in FNP	Crude OR (95% CI)	Adjusted <sup>a</sup> OR (95% CI)	N eligible mothers	N enrolled in FNP	% enrolled in FNP	Crude OR (95% CI)	Adjusted <sup>a</sup> OR (95% CI)
Not linked to NPD	4140 (34.5)	865	20.9	0.59 (0.53 to 0.66)	- <sup>c</sup>	1705 (12.5)	260	15.2	0.58 (0.50 to 0.67)	- <sup>c</sup>	600 (11.0)	95	15.8	0.60 (0.47 to 0.77)	- <sup>c</sup>
Linked to NPD but not to NPD census	190 (1.6)	45	23.7	0.70 (0.50 to 1.00)	- <sup>c</sup>	110 (0.8)	20	18.2	0.73 (0.45 to 1.18)	- <sup>c</sup>	45 (0.8)	-	-	0.60 (0.27 to 1.37)	- <sup>c</sup>
Ever recorded as receiving FSM before 20 weeks of pregnancy															
No	2655 (22.1)	820	30.9	1 (ref)	1 (ref)	6080 (44.6)	1440	23.7	1 (ref)	1 (ref)	2575 (47.3)	560	21.7	1 (ref)	1 (ref)
Yes	5020 (41.8)	1870	37.3	1.29 (1.17 to 1.43)	1.03 (0.92 to 1.15)	5730 (42.1)	2010	35.1	1.77 (1.63 to 1.92)	1.21 (1.10 to 1.33)	2220 (40.8)	740	33.3	1.79 (1.57 to 2.04)	1.18 (1.02 to 1.38)
Not linked to NPD	4140 (34.5)	865	20.9	0.56 (0.50 to 0.63)	- <sup>c</sup>	1705 (12.5)	260	15.2	0.57 (0.50 to 0.67)	- <sup>c</sup>	600 (11.0)	95	15.8	0.59 (0.46 to 0.75)	- <sup>c</sup>
Linked to NPD but not to NPD census	190 (1.6)	45	23.7	0.66 (0.47 to 0.94)	- <sup>c</sup>	110 (0.8)	20	18.2	0.73 (0.45 to 1.18)	- <sup>c</sup>	45 (0.8)	-	-	0.59 (0.26 to 1.33)	- <sup>c</sup>
Ever in IDACI bottom decile before 20 weeks of pregnancy															
No	3355 (27.9)	1065	31.7	1 (ref)	1 (ref)	9775 (71.7)	2755	28.2	1 (ref)	1 (ref)	3860 (71.0)	1015	26.3	1 (ref)	1 (ref)
Yes	4325 (36.0)	1625	37.6	1.24 (1.12 to 1.37)	1.11 (0.99 to 1.24)	2035 (14.9)	695	34.2	1.40 (1.25 to 1.56)	0.99 (0.88 to 1.12)	935 (17.2)	280	29.9	1.41 (1.19 to 1.67)	1.06 (0.88 to 1.29)
Not linked to NPD	4140 (34.5)	865	20.9	0.54 (0.48 to 0.60)	- <sup>c</sup>	1705 (12.5)	260	15.2	0.46 (0.40 to 0.52)	- <sup>c</sup>	600 (11.0)	95	15.8	0.47 (0.37 to 0.59)	- <sup>c</sup>
Linked to NPD but not to NPD census	190 (1.6)	45	23.7	0.64 (0.45 to 0.90)	- <sup>c</sup>	110 (0.8)	20	18.2	0.58 (0.36 to 0.94)	- <sup>c</sup>	45 (0.8)	-	-	0.47 (0.21 to 1.08)	- <sup>c</sup>

continued



**TABLE 40** Predictors of enrolment in the FNP by financial year, among mothers aged 13–19 at LMP, living in a LA with an active FNP site at the time of first antenatal appointment – England, births between April 2010 and March 2017 (continued)

	London					South-East					South-West				
	N eligible mothers	N enrolled in FNP	% enrolled in FNP	Crude OR (95% CI)	Adjusted <sup>a</sup> OR (95% CI)	N eligible mothers	N enrolled in FNP	% enrolled in FNP	Crude OR (95% CI)	Adjusted <sup>a</sup> OR (95% CI)	N eligible mothers	N enrolled in FNP	% enrolled in FNP	Crude OR (95% CI)	Adjusted <sup>a</sup> OR (95% CI)
Educational attainment before 20 weeks of pregnancy															
Did not achieve 5 A*–C GCSEs	5970 (49.7)	2010	33.7	1 (ref)	1 (ref)	9005 (66.1)	2530	28.1	1 (ref)	1 (ref)	3620 (66.5)	940	26	1 (ref)	1 (ref)
Achieved 5 A*–C GCSEs	1355 (11.3)	400	29.5	0.82 (0.72 to 0.93)	1.00 (0.87 to 1.15)	2120 (15.6)	480	22.6	0.72 (0.65 to 0.81)	1.01 (0.89 to 1.14)	935 (17.2)	200	21.4	0.80 (0.67 to 0.96)	1.13 (0.93 to 1.37)
Not linked to NPD	4140 (34.5)	865	20.9	0.50 (0.46 to 0.55)	– <sup>c</sup>	1705 (12.5)	260	15.2	0.45 (0.39 to 0.52)	– <sup>c</sup>	600 (11.0)	95	15.8	0.47 (0.37 to 0.60)	– <sup>c</sup>
Had not attempted GCSEs	540 (4.5)	325	60.2	3.04 (2.53 to 3.65)	1.41 (1.13 to 1.76)	795 (5.8)	460	57.9	3.95 (3.39 to 4.60)	1.44 (1.19 to 1.74)	290 (5.3)	165	56.9	4.46 (3.47 to 5.74)	1.72 (1.25 to 2.36)
Ever excluded, in PRU, or alternative provision															
No	5130 (42.7)	1645	32.1	1 (ref)	1 (ref)	7900 (58.0)	2060	26.1	1 (ref)	1 (ref)	3630 (66.7)	865	23.8	1 (ref)	1 (ref)
Yes	2735 (22.8)	1090	39.9	1.42 (1.28 to 1.56)	1.05 (0.94 to 1.17)	4020 (29.5)	1410	35.1	1.59 (1.46 to 1.73)	1.06 (0.96 to 1.16)	1215 (22.3)	435	35.8	1.71 (1.48 to 1.97)	1.04 (0.88 to 1.22)
Not linked to NPD	4140 (34.5)	865	20.9	0.54 (0.49 to 0.60)	– <sup>c</sup>	1705 (12.5)	260	15.2	0.51 (0.44 to 0.59)	– <sup>c</sup>	600 (11.0)	95	15.8	0.51 (0.40 to 0.65)	– <sup>c</sup>
Ever persistently absent in a term (≥ 10% possible sessions)															
No	5215 (43.4)	1510	29	1 (ref)	1 (ref)	7475 (54.9)	1560	20.9	1 (ref)	1 (ref)	3205 (58.9)	645	20.1	1 (ref)	1 (ref)
Yes	2655 (22.1)	1225	46.1	2.19 (1.98 to 2.41)	1.38 (1.22 to 1.55)	4445 (32.6)	1910	43	3.06 (2.81 to 3.33)	1.62 (1.46 to 1.80)	1640 (30.1)	660	40.2	2.86 (2.49 to 3.27)	1.51 (1.27 to 1.79)
Not linked to NPD	4140 (34.5)	865	20.9	0.63 (0.57 to 0.69)	– <sup>c</sup>	1705 (12.5)	260	15.2	0.69 (0.60 to 0.80)	– <sup>c</sup>	600 (11.0)	95	15.8	0.65 (0.51 to 0.83)	– <sup>c</sup>

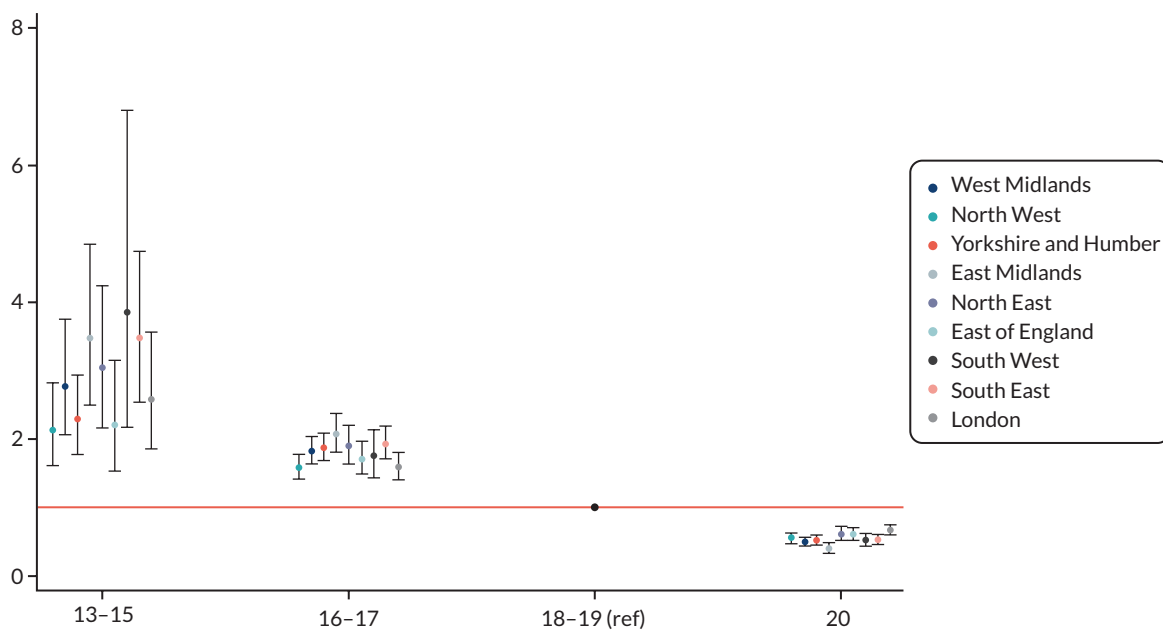
a Adjusted models included all variables in the table as covariates.

b Includes only mothers aged 19 at LMP.

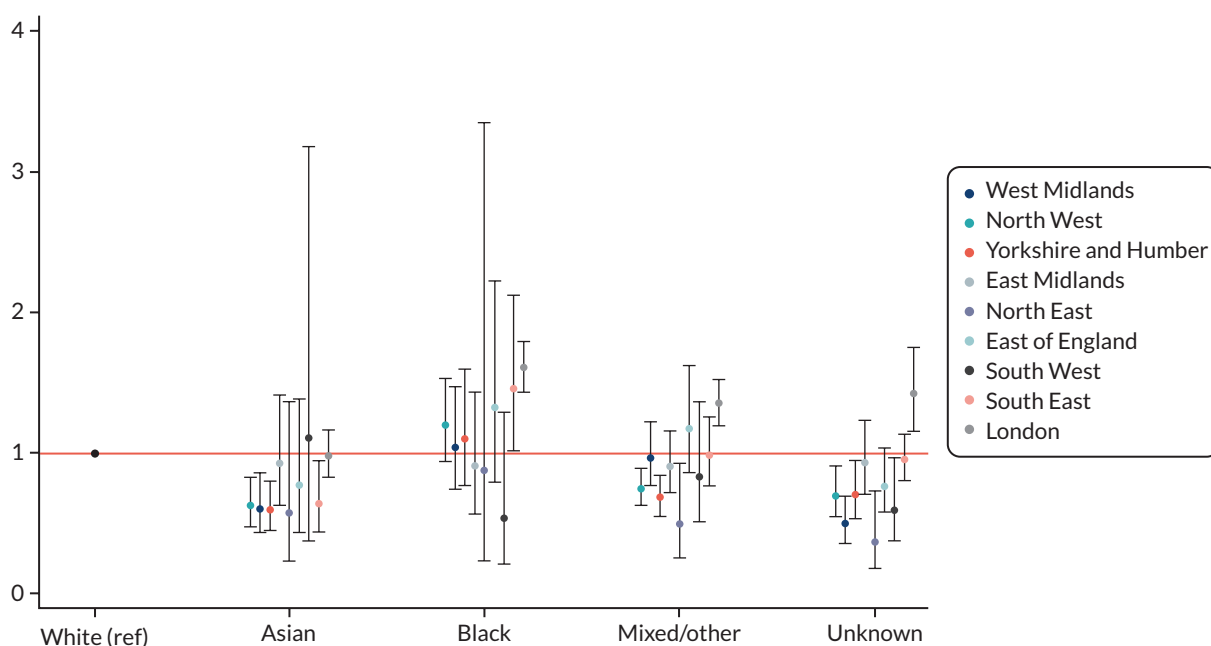
c Estimates omitted due to multicollinearity.

#### Note

Numbers have been rounded to the nearest 5 and cell sizes < 10 have been suppressed, in accordance with NHS Digital's and DfE's statistical disclosure rules for subnational analyses.



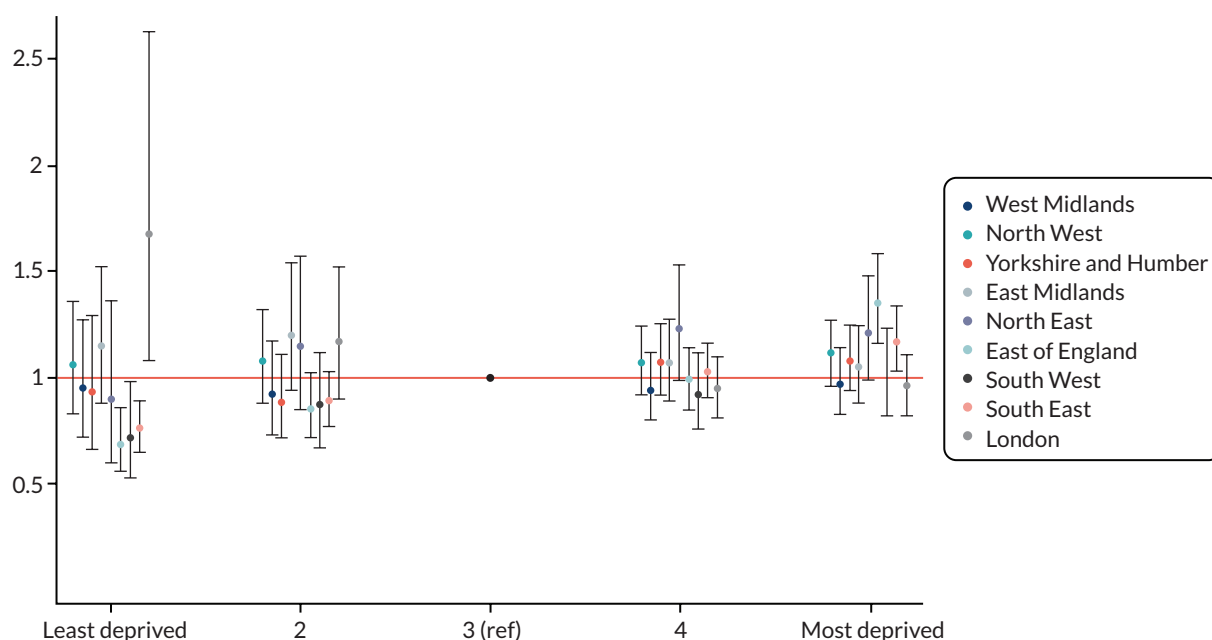
**FIGURE 24** Adjusted ORs and 95% CIs comparing FNP enrolment by maternal age, stratified by region.



**FIGURE 25** Adjusted ORs and 95% CIs comparing FNP enrolment by ethnic group, stratified by region.

### **Risk factors for enrolment in the Family Nurse Partnership for mothers aged 20–24 at last menstrual period**

Of the 4470 mothers aged 20–24 at LMP living in a LA where 20- to 24-year-old mothers were recruited at the time of their first antenatal appointment, 165 were enrolled in the FNP, accounting for 3.7% (95% CI 3.1% to 4.2%) of eligible mothers (see [Table 12](#)). This percentage varied between 2.2% in Cornwall and 10.9% in Haringey.



**FIGURE 26** Adjusted ORs and 95% CIs comparing FNP enrolment by area-level deprivation (quintile of IMD), stratified by region.

**TABLE 41** Predictors of FNP enrolment among mothers aged 20–24 at LMP, living in a LA with an active FNP site at the time of first antenatal appointment, giving birth between November 2016 and March 2019

	N eligible mothers	N enrolled in FNP	% enrolled in FNP	Crude OR (95% CI)	Adjusted <sup>a</sup> OR (95% CI)
<b>Total</b>	<b>4470</b>	<b>165</b>	<b>3.7</b>	–	–
Maternal age at birth					
20–21	1095 (24.5)	80	7.31	1 (ref)	1 (ref)
22–25 <sup>b</sup>	3375 (75.6)	85	2.52	0.32 (0.23 to 0.43)	0.41 (0.29 to 0.58)
Ethnicity					
White	2460 (55.1)	85	3.46	1 (ref)	1 (ref)
South Asian	510 (11.4)	15	2.94	0.87 (0.47 to 1.63)	1.20 (0.62 to 2.33)
Black	395 (8.8)	25	6.33	2.07 (1.24 to 3.45)	1.71 (0.97 to 3.01)
Mixed/other	405 (9.1)	20	4.94	1.54 (0.91 to 2.62)	1.57 (0.90 to 2.77)
Unknown	695 (15.6)	15	2.16	0.71 (0.41 to 1.22)	1.15 (0.64 to 2.07)
IMD (quintile)					
Least deprived or 2 <sup>c</sup>	410 (9.2)	10	2.44	1.04 (0.49 to 2.17)	1.20 (0.55 to 2.63)
3	835 (18.7)	20	2.4	1 (ref)	1 (ref)
4	1345 (30.1)	40	2.97	1.29 (0.75 to 2.23)	1.06 (0.60 to 1.87)
Most deprived	1875 (42.0)	85	4.53	2.08 (1.24 to 3.47)	1.45 (0.83 to 2.52)
Admission with diagnoses within 2 years before 20 weeks of pregnancy					
Adversity-related	60 (1.3)	10	16.67	6.64 (3.43 to 12.88)	2.20 (0.90 to 5.35)
Mental health (excluding substance misuse and self-harm)	85 (1.9)	10	11.76	4.51 (2.37 to 8.58)	0.76 (0.31 to 1.89)
Any chronic condition	315 (7.1)	30	9.52	3.44 (2.25 to 5.26)	1.86 (1.02 to 3.39)

**TABLE 41** Predictors of FNP enrolment among mothers aged 20–24 at LMP, living in a LA with an active FNP site at the time of first antenatal appointment, giving birth between November 2016 and March 2019 (continued)

	N eligible mothers	N enrolled in FNP	% enrolled in FNP	Crude OR (95% CI)	Adjusted <sup>a</sup> OR (95% CI)
A&E attendance	2465 (55.2)	130	5.27	3.57 (2.40 to 5.30)	2.41 (1.57 to 3.68)
Gestational age at antenatal booking appointment					
Before 10 weeks	815 (18.3)	30	3.7	1 (ref)	1 (ref)
10–20 weeks	1240 (27.8)	50	4	1.03 (0.64 to 1.65)	0.98 (0.60 to 1.61)
20 weeks or more	165 (3.7)	10	6.1	1.53 (0.72 to 3.23)	1.90 (0.84 to 4.32)
Unknown	2245 (50.3)	70	3.1	0.82 (0.51 to 1.32)	0.77 (0.46 to 1.28)
Linked to NPD					
Linked to NPD	2610 (58.5)	110	4.2	1 (ref)	1 (ref)
Not linked to NPD	1810 (40.5)	50	2.8	0.54 (0.38 to 0.77)	2.41 (1.22 to 4.75)
Linked to NPD but not to NPD census	50 (1.1)	–	–	0.72 (0.17 to 3.08)	2.79 (0.58 to 13.35)
Ever had a CPP or was looked after					
No CPP or Looked After before 20 weeks of pregnancy	2560 (57.3)	90	3.5	1 (ref)	1 (ref)
Looked After before 20 weeks of pregnancy	85 (1.9)	25	29.4	10.53 (6.12 to 18.10)	6.60 (3.58 to 12.18)
CPP before 20 weeks of pregnancy, but not Looked After	15 (0.3)	–	–	4.52 (0.99 to 20.68)	1.78 (0.35 to 9.01)
Ever recorded as having SEN provision					
No	1430 (32.0)	30	2.1	1 (ref)	1 (ref)
Yes	1180 (26.4)	85	7.2	3.81 (2.46 to 5.90)	2.04 (1.24 to 3.35)
Ever recorded as receiving FSM					
No	1370 (30.7)	25	1.8	1 (ref)	1 (ref)
Yes	1240 (27.8)	90	7.3	4.37 (2.74 to 6.96)	2.86 (1.72 to 4.76)
Ever in IDACI bottom decile					
No	1710 (38.3)	60	3.5	1 (ref)	1 (ref)
Yes	900 (20.2)	50	5.6	1.64 (1.09 to 2.45)	0.77 (0.48 to 1.22)
Educational attainment					
Did not achieve 5 A*–C GCSEs prior to 20 weeks of pregnancy	1740 (39.0)	90	5.2	1 (ref)	1 (ref)
5 A*–C GCSEs gained prior to 20 weeks	915 (20.5)	20	2.2	0.43 (0.27 to 0.69)	0.97 (0.56 to 1.67)
Ever excluded, in PRU, or alternative provision					
No	2155 (48.3)	75	3.5	1 (ref)	1 (ref)
Yes	505 (11.3)	40	7.9	2.14 (1.43 to 3.22)	1.03 (0.65 to 1.65)

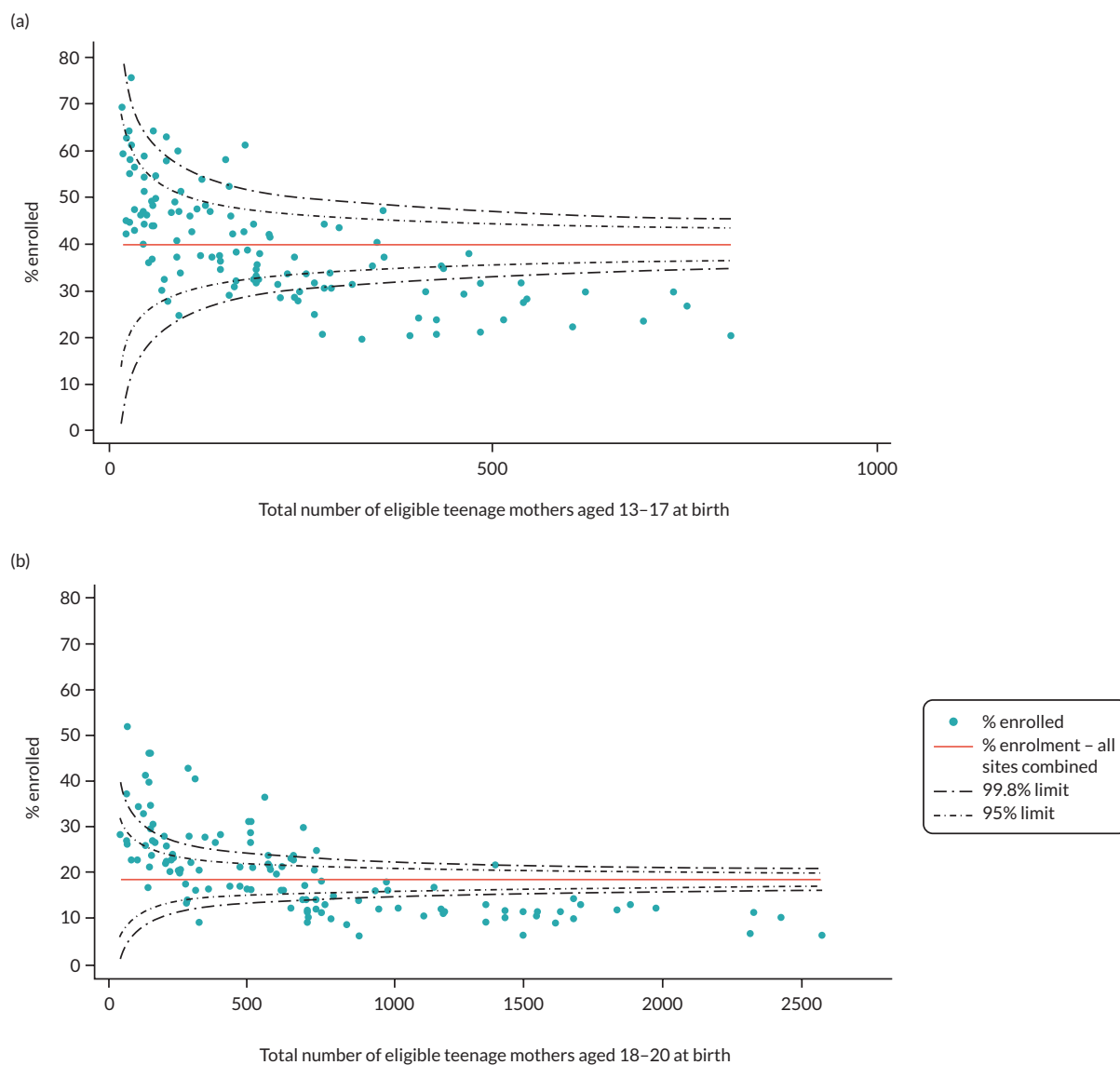
a Adjusted models included all variables in the table as covariates.

b Includes only mothers aged ≤ 24 at LMP.

c The two least deprived quintiles were grouped due to small numbers.

#### Note

Numbers have been rounded to the nearest 5 and cell sizes < 10 have been suppressed, in accordance with NHS Digital's and DfE's statistical disclosure rules for subnational analyses.



**FIGURE 27** Adjusted funnel plots of variation in FNP enrolment among eligible first-time adolescent mothers across FNP sites, by maternal age at birth. (a) Mothers aged 13-17 at birth; (b) mothers aged 18-20 at birth, births between April 2010 and March 2017. Note: adjusted percentages of eligible mothers enrolled adjust for all maternal risk factors (maternal age at birth, ethnicity, area-level deprivation quintile, any unplanned mental health-related, adversity-related, and chronic condition-related hospital admission in 2 years before 20 weeks of pregnancy, and any A&E attendance in 2 years before 20 weeks of pregnancy).

Similar to the 13-19 age group, older mothers were less likely to be enrolled than younger ones. Women with recent A&E attendances were also more likely to be enrolled than those without recent A&E attendances [OR 2.4 (95% CI 1.6 to 3.7)]. Mothers who were Looked After had 6.6 (95% CI 3.6 to 12.2) times higher odds of being enrolled in the FNP, and mothers ever recorded as having SEN provision and receiving FSM had 2-3 times higher odds of being enrolled in the FNP.

## **Appendix 6** Maternal and child outcomes according to maternal risk factors at enrolment or 20 weeks of pregnancy

**TABLE 42** Indicators of child maltreatment among study cohort of first-time mothers aged 13–19 according to risk factors at enrolment or 20 weeks of pregnancy

	Discharge to social services at birth			Unplanned admission for maltreatment or injury – 2 years			Social care data	Ever Looked After	Ever CPP		Ever had a CiN referral		Unplanned admission for maltreatment or injury – 7 years			
	Total	N with outcome	%	Total	N with outcome	%	Total	N with outcome	%	N with outcome	%	N with outcome	%	Total	N with outcome	%
<b>Total</b>	<b>128,270</b>	<b>630</b>	<b>0.5</b>	<b>108,675</b>	<b>5790</b>	<b>5.3</b>	<b>17,605</b>	<b>355</b>	<b>2.0</b>	<b>1840</b>	<b>2.1</b>	<b>3890</b>	<b>22.1</b>	<b>27,015</b>	<b>3175</b>	<b>11.8</b>
FNP participation																
No	97,085	375	0.4	83,040	4090	4.9	14,355	270	1.9	1345	2.0	3055	21.3	22,640	2575	11.4
Yes	31,190	255	0.8	25,630	1700	6.6	3250	85	2.6	495	2.3	835	25.7	4375	600	13.7
Maternal age (years)																
13–15	2645	55	2.0	2345	140	6	360	15	3.6	60	3.2	120	33.5	585	80	13.8
16–17	25,630	205	0.8	22,345	1355	6.1	3765	125	3.4	570	3.1	1120	29.7	5825	760	13.0
18–19	71,150	305	0.4	59,950	3215	5.4	9720	185	1.9	950	1.9	2065	21.2	14,740	1745	11.8
20 <sup>a</sup>	28,845	65	0.2	24,030	1080	4.5	3760	35	0.9	255	1.3	585	15.6	5870	590	10.1
Ethnicity																
White	108,110	535	0.5	92,255	5100	5.5	15,290	320	2.1	1675	2.2	3485	22.8	23,260	2825	12.1
South Asian	3620	15	0.4	3100	115	3.7	430	–	–	20	0.9	60	14.4	670	55	8.3
Black	4545	35	0.8	3880	170	4.4	740	15	2.0	60	1.9	135	18.2	1190	110	9.2
Mixed/other	6675	25	0.4	5560	245	4.4	785	15	2.2	60	1.5	165	21.1	1310	135	10.2
Unknown	5315	25	0.5	3880	160	4.1	355	–	–	20	0.7	45	12.6	585	50	8.6
Area-level deprivation																
Least deprived	6725	25	0.4	5475	260	4.7	745	–	–	40	0.9	–	–	1105	115	10.5
2	10,265	40	0.4	8435	430	5.1	1170	–	–	85	1.2	190	16.2	1820	215	11.9
3	17,610	85	0.5	14,620	755	5.2	2140	40	1.8	200	1.7	415	19.5	3320	345	10.4
4	31,955	150	0.5	27,000	1420	5.3	4305	70	1.6	430	1.9	855	19.9	6705	770	11.5

	Discharge to social services at birth			Unplanned admission for maltreatment or injury – 2 years			Social care data	Ever Looked After		Ever CPP		Ever had a CiN referral		Unplanned admission for maltreatment or injury – 7 years		
	Total	N with outcome	%	Total	N with outcome	%		Total	N with outcome	%	N with outcome	%	N with outcome	%	Total	N with outcome
Most deprived	61,550	325	0.5	52,995	2915	5.5	9235	230	2.5	1080	2.5	-	-	14,050	1725	12.3
Maternal history of admissions with diagnoses within 2 years prior to 20 weeks of pregnancy																
Adversity	5405	90	1.7	4405	375	8.5	630	30	4.6	145	4.1	240	38.3	1000	155	15.7
Violence	475	20	4	400	40	9.8	75	-	-	15	4.2	30	39.2	125	15	12.1
Self-harm	4000	70	1.8	3235	290	9	440	15	3.9	100	3.8	165	37.4	700	120	17.4
Substance misuse	4895	75	1.5	3980	335	8.4	555	25	4.7	130	4	210	38	885	140	15.6
Mental health (exc. self-harm/substance misuse)	3290	60	1.9	2380	230	9.7	215	-	-	50	2.7	70	33.3	365	65	17.4
Mental health (any)	6460	110	1.7	5075	435	8.6	650	30	4.6	155	3.7	245	37.7	1045	175	16.9
A&E visits	81,010	485	0.6	67,860	4130	6.1	10,210	245	2.4	1305	2.3	2535	24.8	15,870	2075	13.1
Repeated A&E visits (≥ 4)	20,750	230	1.1	16,750	1390	8.3	2005	75	3.7	415	3	655	32.8	3315	575	17.4
Did not attend ≥ 1 outpatient appointment	36,945	280	0.8	30,400	1930	6.3	4260	125	3	635	2.6	1120	26.3	6660	870	13.1
Gestational age at booking																
Before 10 weeks	34,850	115	0.3	29,020	1635	5.6	4130	75	1.8	475	1.9	910	22	6565	795	12.1
10–20 weeks	47,480	190	0.4	40,200	2150	5.3	6940	135	2	685	2.1	1510	21.8	10,335	1225	11.8
20 weeks or more	7245	55	0.8	6035	295	4.9	1130	20	1.9	115	2.4	265	23.6	1725	200	11.5
Unknown	38,695	270	0.7	33,420	1715	5.1	5405	125	2.3	565	2.1	1200	22.2	8390	960	11.4
Social care and educational characteristics before 20 weeks of pregnancy																
CLA	6835	225	3.3	5450	435	7.9	615	55	9.1	195	4.5	265	43.2	1015	145	14.2

continued



**TABLE 42** Indicators of child maltreatment among study cohort of first-time mothers aged 13–19 according to risk factors at enrolment or 20 weeks of pregnancy (*continued*)

	Discharge to social services at birth			Unplanned admission for maltreatment or injury – 2 years			Social care data	Ever Looked After		Ever CPP		Ever had a CiN referral		Unplanned admission for maltreatment or injury – 7 years		
	Total	N with outcome	%	Total	N with outcome	%		Total	N with outcome	%	N with outcome	%	N with outcome	%	Total	N with outcome
CPP	3820	100	2.6	2450	175	7.1	35	–	–	35	1.9	15	42.9	90	10	13.5
SEN	55,535	415	0.8	46,190	2855	6.2	5650	190	3.4	1015	2.6	1695	30	8940	1195	13.4
FSM	60,365	375	0.6	50,020	2960	5.9	5965	170	2.9	995	2.4	1665	28	9345	1200	12.8
Bottom IDACI decile	38,490	245	0.6	32,005	1870	5.8	4795	115	2.4	645	2.4	1245	26	7280	915	12.6
Excluded, in PRU or alternative provision	32,470	300	0.9	27,460	1745	6.4	3630	150	4.2	720	3.1	1165	32.1	5720	775	13.6
Persistently absent in a term	40,010	285	0.7	34,825	2120	6.1	6100	190	3.1	855	2.9	1680	27.6	9270	1235	13.3
Did not achieve 5 A*–C GCSEs prior to 20 weeks	80,555	425	0.5	68,280	3840	5.6	12,045	265	2.2	1375	2.3	2815	23.4	17,800	2180	12.2
Did not achieve expected levels at KS2 Maths	46,680	335	0.7	40,135	2405	6	6850	190	2.8	925	2.7	1795	26.2	10,245	1330	13
Did not achieve expected levels at KS2 English	34,210	295	0.9	30,005	1865	6.2	5495	160	2.9	790	3.1	1485	27	8110	1075	13.2

KS2, Key Stage 2.

a Includes only mothers aged 19 at LMP.

**Note**

Numbers have been rounded to the nearest 5 and cell sizes < 10 have been suppressed, in accordance with NHS Digital's and DfE's statistical disclosure rules for subnational analyses.

**TABLE 43** Child health outcomes up to 2 years among study cohort of first-time mothers aged 13–19 according to risk factors at enrolment or 20 weeks of pregnancy

	Preterm birth (< 37 weeks)			Low birthweight (< 2500 g)			Hospital data	≥ 1 unplanned admissions for any diagnosis			≥ 1 A&E attendance		≥ 1 outpatient referral	
	Total	N with outcome	%	Total	N with outcome	%	Total	N with outcome	%	N with outcome	%	N with outcome	%	
<b>Total</b>	<b>119,840</b>	<b>10,040</b>	<b>7.8</b>	<b>120,640</b>	<b>9615</b>	<b>7.5</b>	<b>108,675</b>	<b>40,140</b>	<b>36.9</b>	<b>77,725</b>	<b>71.5</b>	<b>55,630</b>	<b>51.2</b>	
FNP participation														
0	91,680	7280	7.5	92,210	6990	7.2	83,040	29,780	35.9	58,155	70.0	41,320	49.8	
1	28,160	2760	8.8	28,430	2625	8.4	25,630	10,360	40.4	19,570	76.3	14,310	55.8	
Maternal age														
13–15	2420	285	10.7	2455	260	9.9	2345	835	35.6	1685	71.8	1260	53.7	
16–17	23,640	2290	8.9	23,905	2090	8.2	22,345	8665	38.8	16,315	73.0	11,590	51.9	
18–19	65,320	5475	7.7	65,985	5320	7.5	59,950	22,170	37.0	42,880	71.5	30,585	51.0	
20 <sup>a</sup>	28,460	1990	6.9	28,295	1945	6.7	24,030	8465	35.2	16,840	70.1	12,190	50.7	
Ethnicity														
White	101,515	8500	7.9	102,120	7895	7.3	92,255	35,270	38.2	66,135	71.7	47,775	51.8	
South Asian	3315	310	8.6	3305	385	10.7	3100	970	31.3	2240	72.2	1595	51.5	
Black	4130	360	7.9	4195	400	8.8	3880	1065	27.4	2840	73.2	1760	45.4	
Mixed/other	6040	535	8.0	6125	580	8.7	5560	1730	31.1	4055	73.0	2670	48.0	
Unknown	4835	330	6.2	4890	355	6.7	3880	1105	28.5	2450	63.2	1830	47.2	
Area-level deprivation														
Least deprived	6280	495	7.3	6370	415	6.2	5475	1885	34.4	3670	67.0	2855	52.1	
2	9550	750	7.3	9655	650	6.3	8435	3060	36.3	5885	69.8	4375	51.9	
3	16,325	1360	7.7	16,525	1185	6.7	14,620	5365	36.7	10,120	69.2	7590	51.9	
4	29,730	2540	8.0	29,980	2360	7.4	27,000	9905	36.7	19,155	70.9	13,705	50.8	
Most deprived	57,810	4875	7.9	57,970	4980	8.1	52,995	19,860	37.5	38,770	73.2	27,025	51.0	

continued

**TABLE 43** Child health outcomes up to 2 years among study cohort of first-time mothers aged 13–19 according to risk factors at enrolment or 20 weeks of pregnancy (continued)

	Preterm birth (< 37 weeks)			Low birthweight (< 2500 g)			Hospital data	≥ 1 unplanned admissions for any diagnosis			≥ 1 A&E attendance		≥ 1 outpatient referral	
	Total	N with outcome	%	Total	N with outcome	%	Total	N with outcome	%	N with outcome	%	N with outcome	%	
History of admissions with diagnoses within 2 years prior to 20 weeks of pregnancy														
Adversity	5075	555	10.2	5100	510	9.4	4405	2090	47.4	3485	79.2	2660	60.4	
Violence	440	55	11.4	445	60	12.5	400	195	48.6	305	76.9	245	61.3	
Self-harm	3750	395	9.9	3770	350	8.8	3235	1525	47.1	2570	79.4	1975	61.1	
Substance misuse	4590	495	10.1	4615	455	9.3	3980	1900	47.7	3150	79.1	2410	60.6	
Mental health (exc. self-harm/substance misuse)	3090	365	11.1	3115	345	10.5	2380	1185	49.9	1925	80.9	1525	64.1	
Mental health (any)	6065	665	10.3	6100	610	9.5	5075	2435	48.0	4025	79.4	3100	61.1	
Chronic condition (any, exc. mental health)	14,350	1605	11.2	14,430	1395	9.7	12,515	5975	47.7	9885	79.0	7515	60.0	
A&E visits	75,670	6790	8.4	76,190	6510	8.0	67,860	27,770	40.9	52,125	76.8	36,775	54.2	
Repeated A&E visits (≥ 4)	19,310	2025	9.8	19,430	1915	9.2	16,750	8270	49.4	14,260	85.1	10,175	60.7	
Did not attend ≥ 4 1 outpatient appointment	34,290	3440	9.3	34,560	3240	8.8	30,400	12,285	40.4	23,080	75.9	16,755	55.1	
Gestational age at booking														
Before 10 weeks	34,845	2925	8.4	34,745	2685	7.7	29,020	11,550	39.8	21,095	72.7	15,205	52.4	
10–20 weeks	47,455	3530	7.4	47,345	3620	7.6	40,200	14,860	37.0	28,785	71.6	19,995	49.7	
20 weeks or more	7240	750	10.3	7220	690	9.5	6035	2115	35.1	4150	68.7	2960	49.0	
Unknown	30,300	2835	7.3	31,330	2615	6.8	33,420	11,615	34.8	23,695	70.9	17,470	52.3	

	Preterm birth (< 37 weeks)			Low birthweight (< 2500 g)			Hospital data	≥ 1 unplanned admissions for any diagnosis			≥ 1 A&E attendance		≥ 1 outpatient referral	
	Total	N with outcome	%	Total	N with outcome	%	Total	N with outcome	%	N with outcome	%	N with outcome	%	
Social care and educational characteristics before 20 weeks of pregnancy														
CLA	6305	660	9.7	6345	685	10.0	5450	2235	41.0	4080	74.9	3220	59.1	
CPP	3535	395	10.3	3560	430	11.2	2450	990	40.5	1845	75.4	1585	61.6	
SEN	51,580	4705	8.5	51,940	4670	8.4	46,190	18,070	39.1	34,065	73.7	1455	59.4	
FSM	56,100	4970	8.2	56,525	5045	8.4	50,020	19,360	38.7	36,840	73.7	24,790	53.7	
Bottom IDACI decile	35,895	3120	8.1	36,105	3275	8.5	32,005	12,305	38.5	24,030	75.1	26,520	53.0	
Excluded, in PRU or alternative provision	30,070	2735	8.4	30,275	2815	8.7	27,460	10,910	39.7	20,505	74.7	16,670	52.1	
Persistently absent in a term	36,880	3240	8.1	37,245	3145	7.9	34,825	13,615	39.1	25,420	73.0	14,485	52.7	
Did not achieve 5 A*-C GCSEs prior to 20 weeks	74,775	6350	8.5	75,185	6360	8.5	79,890	25,850	38.1	49,215	72.5	35,105	51.7	
Did not achieve expected levels at KS2 Maths	43,560	3855	8.8	43,800	3940	9.0	46,680	15,360	38.3	29,015	72.3	21,070	52.5	
Did not achieve expected levels at KS2 English	32,020	2845	8.9	32,175	2905	9.0	34,210	11,695	39	21,785	72.6	15,900	53.0	
<b>KS2, Key Stage 2.</b> a Includes only mothers aged 19 at LMP. <b>Note</b> Numbers have been rounded to the nearest 5 and cell sizes < 10 have been suppressed, in accordance with NHS Digital's and DfE's statistical disclosure rules for subnational analyses.														

**TABLE 44** Child education outcomes up to age 7 among study cohort of first-time mothers aged 13–19 according to risk factors at enrolment or 20 weeks of pregnancy

	Nursery attendance			SEN			FSM			Persistent absence		
	Total	N	%	Total	N	%	Total	N	%	Total	N	%
<b>Total</b>	<b>66,085</b>	<b>63,625</b>	<b>96.3</b>	<b>30,865</b>	<b>7920</b>	<b>25.7</b>	<b>30,865</b>	<b>14,575</b>	<b>47.2</b>	<b>31,150</b>	<b>17,695</b>	<b>56.8</b>
FNP participation												
No	52,480	50,465	96.2	25,655	6450	25.1	25,655	11,665	45.5	25,900	14,525	56.1
Yes	13,605	13,160	96.7	5210	1470	28.2	5210	2910	55.9	5250	3170	60.4
Maternal age												
13–15	1465	1385	94.6	670	185	28.0	670	390	58.1	670	395	59.1
16–17	13,930	13,280	95.3	6610	1755	26.5	6610	3745	56.6	6660	4110	61.7
18–19	36,200	34,935	96.5	16,835	4380	26.0	16,835	7840	46.6	17,000	9590	56.4
20 <sup>a</sup>	14,490	14,020	96.8	6750	1600	23.7	6750	2605	38.6	6815	3595	52.8
Ethnicity												
White	57,295	55,395	96.7	26,950	6950	25.8	26,950	12,775	47.4	27,150	15,480	57.0
South Asian	1745	1660	95.4	720	175	24.1	720	260	36.2	740	415	56.2
Black	2350	2215	94.2	1230	280	22.9	1230	650	52.8	1255	675	54.0
Mixed/other	3005	2740	91.1	1345	355	26.4	1345	645	48.0	1375	800	58.1
Unknown	1690	1615	95.7	620	160	25.4	620	250	40.1	630	325	51.3
Area-level deprivation												
Least deprived	3150	3070	97.4	1320	280	21.1	1320	415	31.4	1330	670	50.4
2	5020	4875	97.1	2185	485	22.2	2185	735	33.5	2210	1130	51.1
3	8775	8545	97.4	3930	875	22.2	3930	1535	39.0	3955	2210	55.8
4	16,310	15,700	96.3	7635	1905	25.0	7635	3385	44.3	7710	4380	56.8
Most deprived	32,785	31,395	95.8	15,775	4370	27.7	15,775	8500	53.9	15,925	9295	58.4

	Nursery attendance			SEN			FSM			Persistent absence		
	Total	N	%	Total	N	%	Total	N	%	Total	N	%
<b>History of admissions with diagnoses within 2 years prior to 20 weeks of pregnancy</b>												
Adversity	2425	2350	96.9	1135	350	31.0	1135	650	57.4	1150	695	60.4
Violence	235	225	97.0	125	45	34.9	125	80	63.5	130	80	63.3
Self-harm	1720	1665	96.9	795	250	31.4	795	435	54.7	800	485	60.7
Substance misuse	2175	2110	97.0	1010	305	30.1	1010	570	56.6	1020	610	59.7
Mental health (exc. self-harm/substance misuse)	1095	1060	97.2	410	125	31.1	410	220	54.3	420	250	59.4
Mental health (any)	2680	2600	97.1	1195	365	30.6	1195	675	56.4	1210	725	59.9
Chronic condition (any, exc. mental health)	7065	6855	97.0	3130	910	29.1	3130	1635	52.2	3165	1895	59.9
A&E visits	40,610	39,230	96.6	18,345	4925	26.8	18,345	9145	49.9	18,505	10,815	58.4
Repeated A&E visits (≥ 4)	9275	8945	96.4	3825	1155	30.2	3825	2050	53.6	3870	2380	61.5
Did not attend ≥ 1 outpatient appointment	17,355	16,665	96.0	7575	2070	27.4	7575	3965	52.4	7665	4660	60.8
<b>Gestational age at booking</b>												
Before 10 weeks	17,565	17,105	97.4	7795	1955	25.1	7795	3410	43.7	7840	4435	56.6
10–20 weeks	24,675	23,800	96.4	12,035	3115	25.9	12,035	5660	47.0	12,135	6860	56.6
20 weeks or more	3720	3480	93.5	1890	525	27.8	1890	930	49.2	1915	1115	58.4
Unknown	20,120	19,240	95.6	9145	2325	25.4	9145	4580	50.1	9260	5280	57.0
<b>Social care and educational characteristics ever before 20 weeks of pregnancy</b>												
CLA	2855	2765	96.9	1140	355	31.3	1140	695	60.8	1150	675	58.6
CPP	775	750	96.5	120	50	39.3	120	80	64.8	125	85	66.7
SEN	26,840	25,950	96.7	10,850	3455	31.9	10,850	6205	57.2	10,935	6580	60.2

continued

**TABLE 44** Child education outcomes up to age 7 among study cohort of first-time mothers aged 13–19 according to risk factors at enrolment or 20 weeks of pregnancy (continued)

	Nursery attendance			SEN			FSM			Persistent absence		
	Total	N	%	Total	N	%	Total	N	%	Total	N	%
FSM	28,580	27,605	96.6	11,245	3330	29.6	11,245	6735	59.9	11,335	6795	59.9
Bottom IDACI decile	19,090	18,405	96.4	8525	2395	28.1	8525	4915	57.7	8605	5130	59.6
Excluded, in PRU or alternative provision	16,515	15,960	96.6	6890	1950	28.3	6890	3985	57.8	6945	4270	61.5
Persistently absent in a term	22,355	21,565	96.5	10,635	2860	26.9	10,635	5840	54.9	10,720	6470	60.4
Did not achieve 5 A*-C GCSEs prior to 20 weeks	43,375	41,980	96.8	20,915	5735	27.4	20,915	10,560	50.5	21,050	12,325	58.6
Did not achieve expected levels at KS2 Maths	25,420	24,600	96.8	12,030	3825	31.8	12,030	6625	55.1	12,110	7145	59.0
Did not achieve expected levels at KS2 English	19,385	18,735	96.7	9445	3100	32.8	9445	5395	57.1	9510	5745	60.4

KS2, Key Stage 2.

a Includes only mothers aged 19 at LMP.

**Note**

Numbers have been rounded to the nearest 5 and cell sizes &lt; 10 have been suppressed, in accordance with NHS Digital's and DfE's statistical disclosure rules for subnational analyses.

**TABLE 45** Child development outcomes up to age 7 among study cohort of first-time mothers aged 13–19 according to risk factors at enrolment or 20 weeks of pregnancy

	Good Level of Development			Key Stage 1	KS1 Maths			KS2 Writing		KS2 Reading	
	Total	N	%	Total	N	%	N	%	N	%	
<b>Total</b>	<b>45,200</b>	<b>26,005</b>	<b>57.5</b>	<b>30,315</b>	<b>19,235</b>	<b>63.4</b>	<b>17,005</b>	<b>56.1</b>	<b>19,590</b>	<b>64.6</b>	
<b>FNP participation</b>											
No	36,505	21,170	58.0	25,195	16,080	63.8	14,260	56.6	16,360	64.9	
Yes	8695	4830	55.6	5115	3150	61.6	2745	53.6	3230	63.2	
<b>Maternal age</b>											
13–15 <sup>a</sup>	1005	510	50.5	655	375	57.5	335	51.4	385	58.7	
16–17	9605	5210	54.3	6470	3895	60.2	3370	52.1	3915	60.5	
18–19	24,705	14,260	57.7	16,560	10,535	63.6	9345	56.4	10,750	64.9	
20 <sup>a</sup>	9885	6025	61.0	6630	4425	66.8	3955	59.6	4540	68.5	
<b>Ethnicity</b>											
White	39,525	22,775	57.6	26,505	16,810	63.4	14,820	55.9	17,075	64.4	
South Asian	1090	615	56.5	705	475	67.6	430	61.3	490	70.0	
Black	1650	995	60.2	1205	775	64.3	715	59.2	830	69.0	
Mixed/other	1925	1045	54.3	1295	780	60.5	700	54.2	800	61.8	
Unknown	1005	575	57.0	605	395	65.0	335	55.7	395	65.5	
<b>Area-level deprivation</b>											
Least deprived	2025	1230	60.9	1295	840	64.9	750	58.0	875	67.7	
2	3380	2080	61.5	2155	1415	65.7	1255	58.2	1440	66.8	
3	5975	3555	59.5	3870	2525	65.2	2245	58.0	2575	66.6	
4	11,140	6485	58.2	7480	4820	64.4	4290	57.4	4915	65.7	
Most deprived	2025	1230	60.9	1295	840	64.9	750	58.0	875	67.7	

continued



**TABLE 45** Child development outcomes up to age 7 among study cohort of first-time mothers aged 13–19 according to risk factors at enrolment or 20 weeks of pregnancy (continued)

	Good Level of Development			Key Stage 1	KS1 Maths		KS2 Writing		KS2 Reading	
	Total	N	%	Total	N	%	N	%	N	%
<b>History of admissions with diagnoses within 2 years prior to 20 weeks of pregnancy</b>										
Adversity	1625	880	54.3	1115	670	60.2	585	52.6	700	63.0
Violence	165	85	52.1	120	75	63.1	65	53.3	85	68.0
Self-harm	1140	625	54.9	780	470	60.1	405	51.7	485	62.3
Substance misuse	1450	805	55.3	995	605	60.7	530	53.4	625	63.0
Mental health (exc. self-harm/substance misuse)	645	350	53.9	400	235	58.0	215	53.0	250	62.2
Mental health (any)	1750	960	54.7	1175	700	59.4	620	52.6	730	62.2
Chronic condition (any, exc. mental health)	4680	2620	56.0	3075	1875	61.0	1655	53.8	1940	63.1
A&E visits	27,415	15,575	56.8	18,015	11,320	62.8	9955	55.3	11,575	64.3
Repeated A&E visits (≥ 4)	5965	3305	55.4	3760	2235	59.5	1985	52.8	2300	61.3
Did not attend ≥ 1 outpatient appointment	11,450	6385	55.8	7430	4555	61.3	4040	54.4	4730	63.7
<b>Gestational age at booking</b>										
Before 10 weeks	11,945	7105	59.5	7685	4965	64.6	4470	58.2	5065	65.9
10–20 weeks	17,370	10,105	58.2	11,820	7625	64.5	6680	56.5	7750	65.6
20 weeks or more	2680	1440	53.7	1845	1130	61.1	1005	54.4	1145	62.1
Unknown	13,205	7350	55.7	8960	5515	61.5	4845	54.1	5630	62.8
<b>Social care and educational characteristics ever before 20 weeks of pregnancy</b>										
CLA	1785	910	51.0	1110	625	56.1	545	48.9	645	57.9
CPP	310	150	48.1	120	55	46.6	55	45.8	60	52.5

	Good Level of Development			Key Stage 1	KS1 Maths		KS2 Writing		KS2 Reading	
	Total	N	%	Total	N	%	N	%	N	%
SEN	17,110	8610	50.3	10,640	5835	54.8	4970	46.7	5930	55.7
FSM	17,865	9585	53.7	11,035	6520	59.1	5735	52.0	6700	60.7
Bottom IDACI decile	12,715	7050	55.5	8405	5175	61.6	4500	53.6	5255	62.5
Excluded, in PRU or alternative provision	10,765	5765	53.6	6775	3990	58.9	3455	51.0	4050	59.8
Persistently absent in a term	15,580	8655	55.5	10,445	6370	61.0	5615	53.7	6475	62.0
Did not achieve 5 A*-C GCSEs prior to 20 weeks	30,325	16,750	55.2	20,595	12,505	60.7	11,000	53.4	12,835	62.3
Did not achieve expected levels at KS2 Maths	17,540	8680	49.5	11,840	6335	53.5	5575	47.1	6620	55.9
Did not achieve expected levels at KS2 English	13,495	6380	47.3	9300	4870	52.4	4100	44.1	4895	52.6

KS1/KS2, Key Stage 1/Key Stage 2.

a Includes only mothers aged 19 at LMP.

**Note**

Numbers have been rounded to the nearest 5 and cell sizes < 10 have been suppressed, in accordance with NHS Digital's and DfE's statistical disclosure rules for subnational analyses.

**TABLE 46** Child health outcomes up to 7 years among study cohort of first-time mothers aged 13–19 according to risk factors at enrolment or 20 weeks of pregnancy

	Outcomes at 7 years	≥ 1 Unplanned admission for any diagnosis		≥ 1 A&E attendance		≥ 1 Outpatient referral		Did not attend ≥ 1 outpatient appointment	
		Total	N	%	N	%	N	%	N
<b>Total</b>	<b>27,015</b>	<b>13,195</b>	<b>48.8</b>	<b>23,555</b>	<b>87.2</b>	<b>12,385</b>	<b>45.8</b>	<b>11,150</b>	<b>90</b>
FNP participation									
No	22,640	10,975	48.5	19,570	86.4	10,200	45.1	9145	89.7
Yes	4375	2225	50.9	3985	91.1	2185	49.9	2010	92.0
Maternal age									
13–15	585	295	50.4	515	88.0	280	47.9	260	92.9
16–17	5825	2960	50.8	5105	87.6	2725	46.8	2570	94.3
18–19	14,740	7215	48.9	12,905	87.6	6750	45.8	6090	90.2
20 <sup>a</sup>	5870	2730	46.5	5030	85.7	2630	44.8	2230	84.8
Ethnicity									
White	23,260	11,690	50.3	20,370	87.6	10,735	46.2	9685	90.2
South Asian	670	290	43.3	570	85.1	315	47.0	245	77.8
Black	1190	435	36.6	1030	86.6	515	43.3	505	98.1
Mixed/other	1310	560	42.7	1130	86.3	580	44.3	505	87.1
Unknown	585	225	38.5	450	76.9	240	41.0	210	87.5
Area-level deprivation									
Least deprived	1105	515	46.6	930	84.2	485	43.9	380	78.4
2	1820	865	47.5	1560	85.7	845	46.4	685	81.1
3	3320	1570	47.3	2840	85.5	1490	44.9	1300	87.2
4	6705	3295	49.1	5825	86.9	3050	45.5	2740	89.8
Most deprived	14,050	6945	49.4	12,385	88.1	6505	46.3	6040	92.9
History of admissions with diagnoses within 2 years prior to 20 weeks of pregnancy									
Adversity	1000	585	58.5	910	91.0	555	55.5	500	90.1
Violence	125	75	60.0	110	88.0	70	56.0	65	92.9
Self-harm	700	420	60.0	640	91.4	395	56.4	345	87.3
Substance misuse	885	525	59.3	805	91.0	490	55.4	440	89.8
Mental health (exc. self-harm/substance misuse)	365	220	60.3	330	90.4	220	60.3	175	79.5
Mental health (any)	1045	625	59.8	950	90.9	585	56.0	515	88.0
Chronic condition (any, exc. mental health)	2705	1575	58.2	2455	90.8	1485	54.9	1330	89.6
A&E visits	15,870	8390	52.9	14,330	90.3	7845	49.4	7085	90.3
Repeated A&E visits (≥ 4)	3315	2040	61.5	3110	93.8	1890	57.0	1710	90.5

**TABLE 46** Child health outcomes up to 7 years among study cohort of first-time mothers aged 13–19 according to risk factors at enrolment or 20 weeks of pregnancy (continued)

	Outcomes at 7 years	≥ 1 Unplanned admission for any diagnosis		≥ 1 A&E attendance		≥ 1 Outpatient referral		Did not attend ≥ 1 outpatient appointment		
		Total	N	%	N	%	N	%	N	%
Did not attend ≥ 1 outpatient appointment	6660	3485	52.3	5935	89.1	3340	50.2	3225	96.6	
Gestational age at booking										
Before 10 weeks	6565	3390	51.6	5700	86.8	3000	45.7	2775	92.5	
10–20 weeks	10,335	5080	49.2	9040	87.5	4550	44.0	4240	93.2	
20 weeks or more	1725	800	46.4	1495	86.7	770	44.6	725	94.2	
Unknown	8390	3930	46.8	7320	87.2	4070	48.5	3415	83.9	
Social care and educational characteristics ever before 20 weeks of pregnancy										
CLA	1015	550	54.2	895	88.2	560	55.2	470	83.9	
CPP	90	45	50.0	75	83.3	50	50.0	50	100.0	
SEN	8940	4590	51.3	7890	88.3	4320	48.3	4065	94.1	
FSM	9345	4755	50.9	8245	88.2	4390	47.0	4285	97.6	
Bottom IDACI decile	7280	3635	49.9	6490	89.1	3450	47.4	3265	94.6	
Excluded, in PRU or alternative provision	5720	2925	51.1	5080	88.8	2705	47.3	2610	96.5	
Persistently absent in a term	9270	4740	51.1	8225	88.7	4345	46.9	4120	94.8	
Did not achieve 5 A*–C GCSEs prior to 20 weeks	17,800	8930	50.2	15,650	87.9	8280	46.5	7660	92.5	
Did not achieve expected levels at KS2 Maths	10,245	5130	50.1	8995	87.8	4800	46.9	4540	94.6	
Did not achieve expected levels at KS2 English	10,245	4125	50.9	7130	87.9	3875	47.8	3605	93.0	

KS2, Key Stage 2.

a Includes only mothers aged 19 at LMP.

**Note**

Numbers have been rounded to the nearest 5 and cell sizes &lt; 10 have been suppressed, in accordance with NHS Digital's and DfE's statistical disclosure rules for subnational analyses.

**TABLE 47** Maternal health outcomes among study cohort of first-time mothers aged 13–19 according to risk factors at enrolment or 20 weeks of pregnancy

	Health outcomes up to 2 years following birth	≥ 1 unplanned admission for adversity-related diagnoses		≥ 1 unplanned admission for mental health-related diagnosis		≥ 1 unplanned admission for any diagnosis		≥ 1 A&E attendance		Subsequent delivery within 18 months of index birth		
		Total	N	%	N	%	N	%	N	%	N	%
<b>Total</b>	<b>111,195</b>	<b>1905</b>	<b>1.7</b>	<b>2915</b>	<b>2.6</b>	<b>19,075</b>	<b>17.2</b>	<b>55,020</b>	<b>49.5</b>	<b>10,270</b>	<b>8.7</b>	
FNP enrolment												
Yes	25,860	1205	1.4	1835	2.1	13,830	16.2	40,450	47.4	7935	8.8	
No	85,335	705	2.7	1085	4.2	5245	20.3	14,570	56.3	2335	8.5	
Maternal age												
13–15	2390	105	4.4	85	3.5	435	18.1	1270	53.2	90	3.8	
16–17	22,855	525	2.3	700	3.1	4160	18.2	12,065	52.8	1970	8.2	
18–19	61,470	985	1.6	1595	2.6	10,655	17.3	30,510	49.6	5965	9.2	
20 <sup>a</sup>	24,485	290	1.2	540	2.2	3830	15.7	11,175	45.6	2240	8.5	
Ethnicity												
White	94,285	1705	1.8	2710	2.9	16,840	17.9	47,225	50.1	8755	8.8	
South Asian	3190	40	1.2	40	1.2	505	15.8	1500	46.9	475	14.3	
Black	4000	65	1.6	40	1.0	575	14.3	2165	54.1	275	6.5	
Mixed/other	5740	85	1.5	110	1.9	910	15.8	2930	51.0	535	8.9	
Unknown	3980	10	0.2	15	0.4	250	6.3	1200	30.2	230	5.3	
Area-level deprivation												
Least deprived	5580	95	1.7	175	3.1	940	16.8	2550	45.7	390	6.6	
2	8615	165	1.9	235	2.7	1485	17.2	4140	48.1	630	6.8	
3	14,935	230	1.5	415	2.8	2515	16.9	7325	49.0	1245	7.7	
4	27,665	475	1.7	735	2.7	4705	17.0	13,635	49.3	2530	8.6	

	Health outcomes up to 2 years following birth	≥ 1 unplanned admission for adversity-related diagnoses		≥ 1 unplanned admission for mental health-related diagnosis		≥ 1 unplanned admission for any diagnosis		≥ 1 A&E attendance		Subsequent delivery within 18 months of index birth	
		Total	N	%	N	%	N	%	N	%	N
Most deprived	54,250	935	1.7	1355	2.5	9400	17.3	27,280	50.3	5460	9.6
History of admissions with diagnoses within 2 years prior to 20 weeks of pregnancy											
Adversity	4480	390	8.7	500	11.2	1515	33.8	3160	70.5	525	11.0
Violence	405	35	8.4	35	8.9	145	35.2	300	73.9	45	10.8
Self-harm	3295	320	9.7	405	12.3	1135	34.5	2340	71.0	385	11.0
Substance misuse	4050	365	9.0	470	11.6	1380	34.1	2835	70.1	470	10.8
Mental health (exc. self-harm/substance misuse)	2430	230	9.4	460	19.0	1015	41.8	1800	74.1	325	11.8
Mental health (any)	5165	425	8.3	670	12.9	1830	35.4	3670	71.0	610	10.8
Chronic condition (any, exc. mental health)	9645	525	5.4	920	9.5	3400	35.2	6815	70.7	1070	10.2
A&E visits	69,400	1570	2.3	2495	3.6	14,570	21.0	40,455	58.3	6940	9.4
Repeated A&E visits (≥ 4)	17,040	695	4.1	1210	7.1	5435	31.9	12,945	76.0	2100	11.5
Did not attend ≥ 1 outpatient appointment	31,120	805	2.6	1315	4.2	6920	22.2	18,255	58.6	3315	10.0
Gestational age at antenatal booking appointment											
Before 10 weeks	29,570	520	1.8	900	3.0	5395	18.2	15,065	50.9	2950	9.3
10–20 weeks	40,865	705	1.7	1020	2.5	6770	16.6	20,055	49.1	3515	8.1
20 weeks or more	6145	115	1.8	160	2.6	920	15.0	2820	45.9	505	7.8
Unknown	34,620	570	1.6	835	2.4	5995	17.3	17,075	49.3	3300	9.1
Social care and educational characteristics ever before 20 weeks of pregnancy											
CLA	5575	305	5.5	395	7.1	1460	26.2	3625	65.0	735	12.3

continued

**TABLE 47** Maternal health outcomes among study cohort of first-time mothers aged 13–19 according to risk factors at enrolment or 20 weeks of pregnancy (continued)

	Health outcomes up to 2 years following birth	≥ 1 unplanned admission for adversity-related diagnoses		≥ 1 unplanned admission for mental health-related diagnosis		≥ 1 unplanned admission for any diagnosis		≥ 1 A&E attendance		Subsequent delivery within 18 months of index birth	
		Total	N	%	N	%	N	%	N	%	N
CPP	2500	100	4.0	150	6.0	590	23.5	1540	61.6	340	12.0
SEN	47,260	1030	2.2	1600	3.4	8965	19.0	25,250	53.4	5005	10.0
FSM	51,110	1090	2.1	1610	3.1	9385	18.4	26,925	52.7	5515	10.2
Bottom IDACI decile	32,690	650	2.0	910	2.8	5910	18.1	17,180	52.5	3425	9.8
Excluded, in PRU or alternative provision	28,035	785	2.8	1005	3.6	5630	20.1	15,655	55.8	3065	10.4
Persistently absent in a term	35,560	815	2.3	1095	3.1	6690	18.8	18,885	53.1	3265	8.8
Did not achieve 5 A*–C GCSEs prior to 20 weeks	69,370	1230	1.8	1950	2.8	12,525	18.1	35,365	51.0	7060	9.7
Did not achieve expected levels at KS2 Maths	41,030	755	1.8	1180	2.9	7360	17.9	21,160	51.6	4255	9.9
Did not achieve expected levels at KS2 English	30,700	560	1.8	860	2.8	5470	17.8	15,905	51.8	3440	10.8

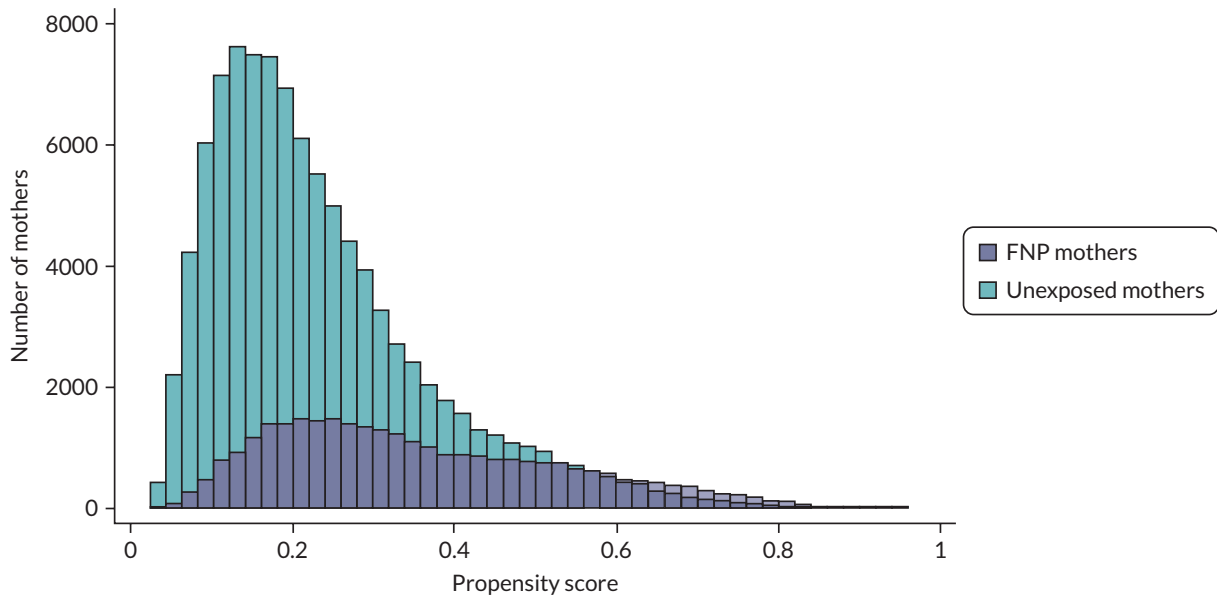
KS2, Key Stage 2.

a Includes only mothers aged 19 at LMP.

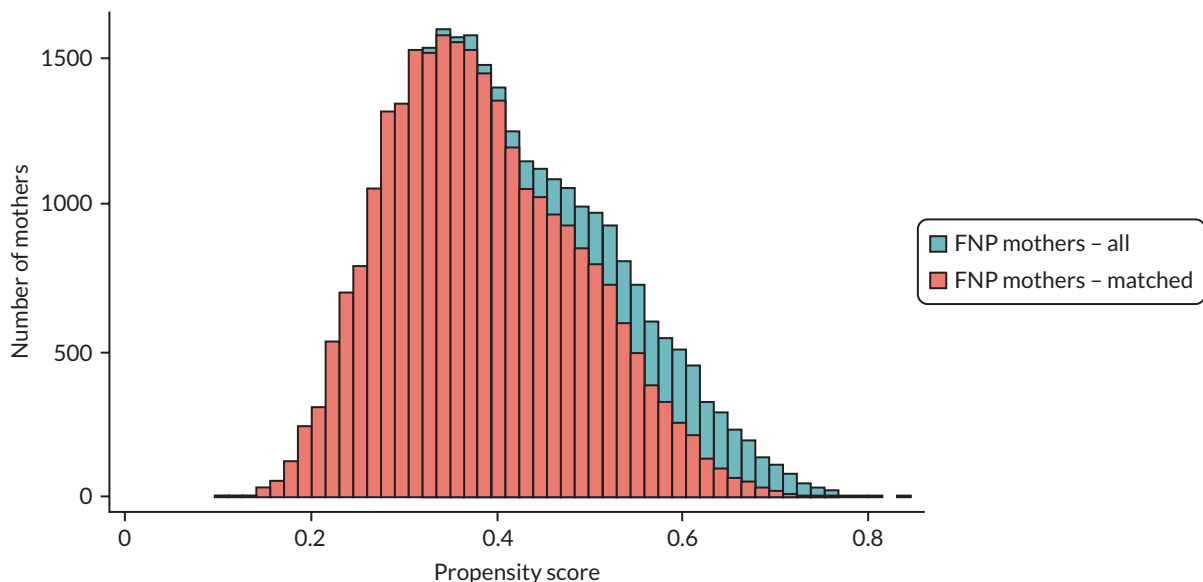
**Note**

Numbers have been rounded to the nearest 5 and cell sizes < 10 have been suppressed, in accordance with NHS Digital's and DfE's statistical disclosure rules for subnational analyses.

## Appendix 7 Additional information on Objective 2: propensity score generation and matching

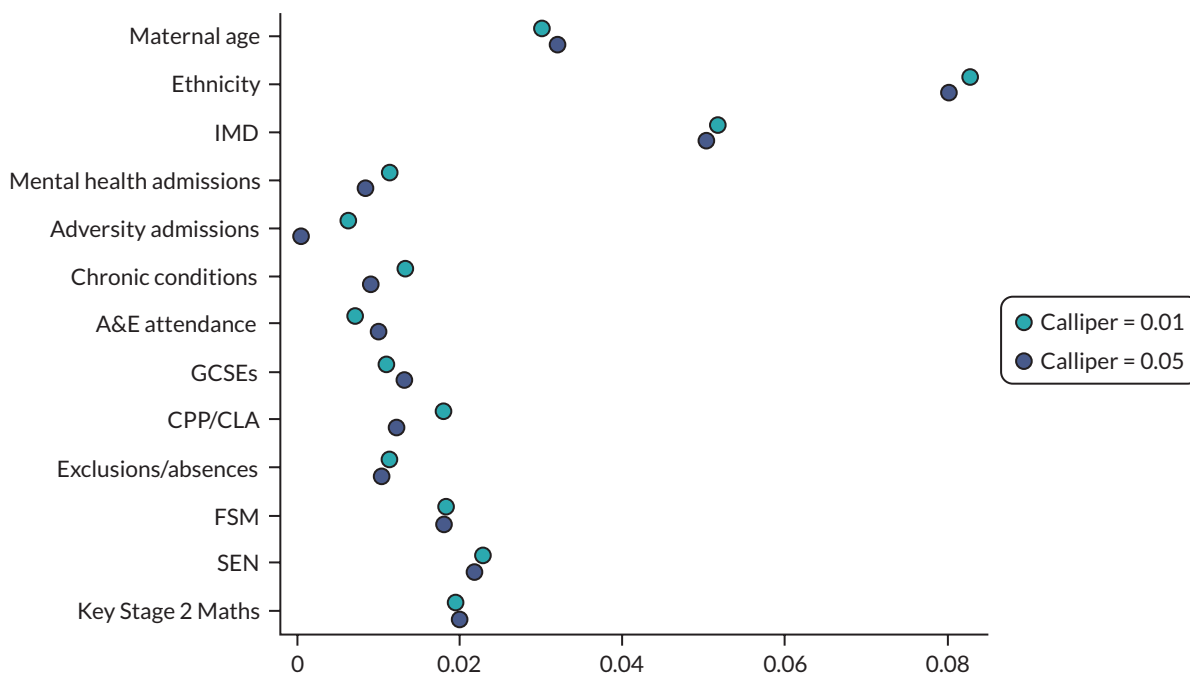


**FIGURE 28** Overlap in the distribution of propensity scores between mothers who were and were not enrolled in FNP.



**FIGURE 29** Propensity scores for all FNP mothers and those included in the matched cohort for analysis.





**FIGURE 30** Standardised differences comparing maternal risk factors in the propensity-score-matched cohort of all mothers aged 13–19 giving birth between April 2010 and March 2019. Note: The final matched cohort used a calliper width of 0.01.

**TABLE 48** Balance of maternal risk factors in the propensity-score-matched cohort of all mothers aged 13–19 giving birth between April 2010 and March 2019

	Mothers enrolled in the FNP (treated)		Mothers never enrolled in the FNP (untreated)	
	N	%	N	%
<b>Total</b>	<b>29,505</b>		<b>29,505</b>	
<b>Maternal age</b>				
13–15	955	3.2	970	3.3
16–17	9290	31.5	9460	32.1
18–19	15,650	53	15,745	53.4
20–21	3610	12.2	3325	11.3
<b>Ethnicity</b>				
White	24,810	84.1	25,635	86.9
South Asian	645	2.2	525	1.8
Black	1380	4.7	1040	3.5
Mixed/other	1595	5.4	1395	4.7
Unknown	1075	3.6	910	3.1
<b>Area-level deprivation</b>				
Least deprived	1395	4.7	1230	4.2
2	2210	7.5	2170	7.4
3	3950	13.4	3740	12.7
4	7495	25.4	7195	24.4

**TABLE 48** Balance of maternal risk factors in the propensity-score-matched cohort of all mothers aged 13–19 giving birth between April 2010 and March 2019 (continued)

	Mothers enrolled in the FNP (treated)		Mothers never enrolled in the FNP (untreated)	
	N	%	N	%
Most deprived	14,455	49.0	15,165	51.4
Year of delivery				
2010	2010	6.8	2295	7.8
2011	1850	6.3	1965	6.7
2012	2815	9.5	2890	9.8
2013	3890	13.2	4075	13.8
2014	3460	11.7	3640	12.3
2015	4695	15.9	4790	16.2
2016	4755	16.1	4520	15.3
2017	2970	10.1	2665	9.0
2018	2480	8.4	2200	7.5
2019	575	1.9	470	1.6
Quarter of delivery				
January–March	7355	24.9	7330	24.8
April–June	7260	24.6	7250	24.6
July–September	7465	25.3	7420	25.1
August–December	7420	25.2	7505	25.4
History of admissions with diagnoses within 2 years prior to 20 weeks of pregnancy				
Adversity	1825	6.2	1780	6.0
Violence	160	0.5	150	0.5
Self-harm	1365	4.6	1320	4.5
Substance misuse	1640	5.6	1615	5.5
Mental health (exc. self-harm/substance misuse)	1150	3.9	1085	3.7
Mental health (any)	2185	7.4	2115	7.2
A&E visits	20,480	69.4	20,575	69.7
Repeated A&E visits ( $\geq 4$ )	6125	20.8	5945	20.1
Did not attend $\geq 1$ outpatient appointment	10,140	37.5	9760	35.7
Gestational age at antenatal booking appointment				
Before 10 weeks	7925	26.9	8355	28.3
10–20 weeks	10,930	37	10,620	36
20 weeks or more	1775	6.0	1435	4.9
Unknown	8875	30.1	9095	30.8

continued

**TABLE 48** Balance of maternal risk factors in the propensity-score-matched cohort of all mothers aged 13–19 giving birth between April 2010 and March 2019 (*continued*)

	Mothers enrolled in the FNP (treated)		Mothers never enrolled in the FNP (untreated)	
	N	%	N	%
Linked to NPD				
Linked to NPD	26,275	89.1	26,395	89.5
Not linked to NPD	3075	10.4	2990	10.1
Not linked to NPD census	150	0.5	120	0.4
Social care and educational characteristics before 20 weeks of pregnancy				
Ever in care	2580	9.8	2485	9.4
Ever had recorded CPP	1470	5.6	1355	5.1
Ever recorded as having SEN	15,790	60.1	15,660	59.3
Ever recorded as having FSM	17,050	64.9	17,055	64.6
Ever in bottom IDACI decile	10,640	40.5	10,580	40.1
Ever excluded, in PRU or alternative provision	9495	36.1	9465	35.9
Ever recorded as persistently absent in a term	13,515	51.4	13,880	52.6
KS2 Maths				
Did not achieve expected level at KS2	12,010	47.5	12,205	48.0
Achieved expected level at KS2	13,275	52.5	13,250	52.1
KS2 English				
Did not achieve expected level at KS2	8910	35.2	9190	36.1
Achieved expected level at KS2	16,380	64.8	16,270	63.9

KS2, Key Stage 2.

## Appendix 8 Additional information on Objective 2

**TABLE 49** Description of all child health, developmental and educational outcomes among study cohort of first-time mothers aged 13–19

	All children in cohort		Children of mothers ever enrolled in FNP		Children of mothers never enrolled in FNP	
	N	%	N	%	N	%
<b>Total with information on birth outcomes (Births between April 2010 and March 2019)</b>	<b>130,415</b>		<b>31,260</b>		<b>99,150</b>	
Total with information on gestational age at birth	121,005		28,075		92,935	
Preterm birth (< 37 weeks)	9940	8.2	2650	9.4	7295	7.8
Total with information on birthweight	121,815		28,350		93,460	
Low birthweight (< 2500 g)	9395	7.7	2515	8.9	6880	7.4
<b>Total with 2 years follow-up (Births between April 2010 and March 2017)</b>	<b>108,675</b>		<b>25,630</b>		<b>83,040</b>	
≥ 1 unplanned admission (any diagnosis)	40,140	36.9	10,360	40.4	29,780	35.9
Mean no. unplanned admissions <sup>a</sup> (SD)		1.9 (1.9)		1.9 (1.9)		1.9 (1.8)
≥ 1 A&E attendance	77,725	71.5	19,570	76.3	58,155	70.0
Mean no. A&E attendances <sup>a</sup> (SD)		3.0 (2.8)		3.3 (3.0)		2.9 (2.7)
≥ 1 outpatient referral	55,630	51.2	14,310	55.8	41,320	49.8
Mean no. referrals <sup>a</sup>		2.3 (2.6)		2.4 (2.5)		2.3 (2.6)
Did not attend ≥ 1 outpatient appointment	19,745	18.2	5485	21.4	14,260	17.2
Mean no. Did not attend <sup>a</sup>		2.0 (1.7)		2.1 (1.9)		2.0 (1.6)
<b>Total with 7 years follow-up (Births between April 2010 and March 2012)</b>	<b>27,015</b>		<b>4375</b>		<b>22,640</b>	
≥ 1 unplanned admission (any diagnosis)	13,195	48.8	2225	50.8	10,975	48.5
Mean no. unplanned admissions <sup>a</sup> (SD)		2.3 (3.2)		2.5 (3.8)		2.3 (3.1)
≥ 1 A&E attendance	23,555	87.2	3985	91.0	19,570	86.4
Mean no. A&E attendances <sup>a</sup> (SD)		4.9 (4.7)		5.5 (5.3)		4.8 (4.6)
≥ 1 outpatient referral	20,450	75.7	3460	79.1	16,990	75
Mean no. referrals <sup>a</sup>		4.0 (4.3)		4.2 (4.6)		3.9 (4.2)
Did not attend ≥ 1 outpatient appointment	11,150	41.3	2010	45.9	9145	40.4
Mean no. Did not attend <sup>a</sup>		3.0 (3.1)		3.2 (3.5)		2.9 (3.1)
<b>Total with information on nursery attendance</b>	<b>25,140</b>		<b>4135</b>		<b>21,010</b>	
Attended nursery between ages 2 and 4	24,090	95.8	3955	90.4	20,135	95.8
<b>Total with information on school readiness at age 5 (EYFSP)</b>	<b>24,585</b>		<b>4035</b>		<b>20,545</b>	
Good Level of Development (across all five domains)	14,445	58.5	2325	53.1	12,120	59.0
GLD: Communication and Language	18,595	75.6	3010	74.6	15,585	75.9
GLD: Physical Development	20,340	82.7	3325	82.4	17,010	82.8
GLD: Personal, Social and Emotional Development	19,345	78.7	3130	77.6	16,215	78.9
GLD: Literacy	15,090	61.4	2435	60.3	12,655	61.6
GLD: Maths	16,630	67.6	2685	66.5	13,945	67.9
<b>Total with information at Key Stage 1</b>	<b>24,530</b>		<b>4040</b>		<b>20,490</b>	
Expected level of development at KS1 (Maths)	16,015	65.3	2580	63.9	13,435	65.6

**TABLE 49** Description of all child health, developmental and educational outcomes among study cohort of first-time mothers aged 13–19 (continued)

	All children in cohort		Children of mothers ever enrolled in FNP		Children of mothers never enrolled in FNP	
	N	%	N	%	N	%
Expected level of development at KS1 (Writing)	14,215	57.9	2255	55.9	11,960	58.4
Expected level of development at KS1 (Reading)	16,255	66.3	2635	65.3	13,620	66.5
<b>Total with information on SEN provision and FSM</b>	<b>24,925</b>		<b>4105</b>		<b>20,820</b>	
Ever recorded as having SEN provision	6175	24.8	1120	27.8	5060	24.3
Ever recorded as having FSM	11,780	47.3	2290	56.8	9485	45.6
<b>Total with information on persistent absence</b>	<b>25,155</b>		<b>4135</b>		<b>21,020</b>	
Ever persistently absent	14,700	58.4	2555	63.3	12,145	57.8

KS1, Key Stage 1.

a Among children with at least one admission/attendance/referral/did not attend.

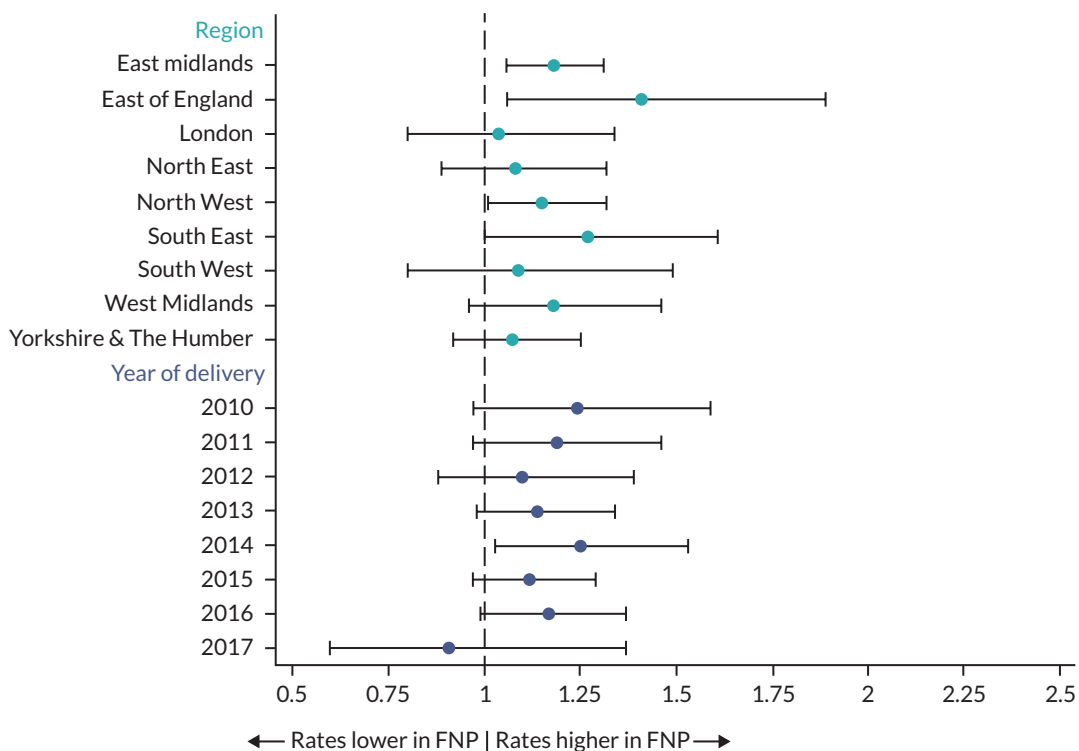
**Note**

Numbers have been rounded to the nearest 5 and cell sizes < 10 have been suppressed, in accordance with NHS Digital's and DfE's statistical disclosure rules for subnational analyses.

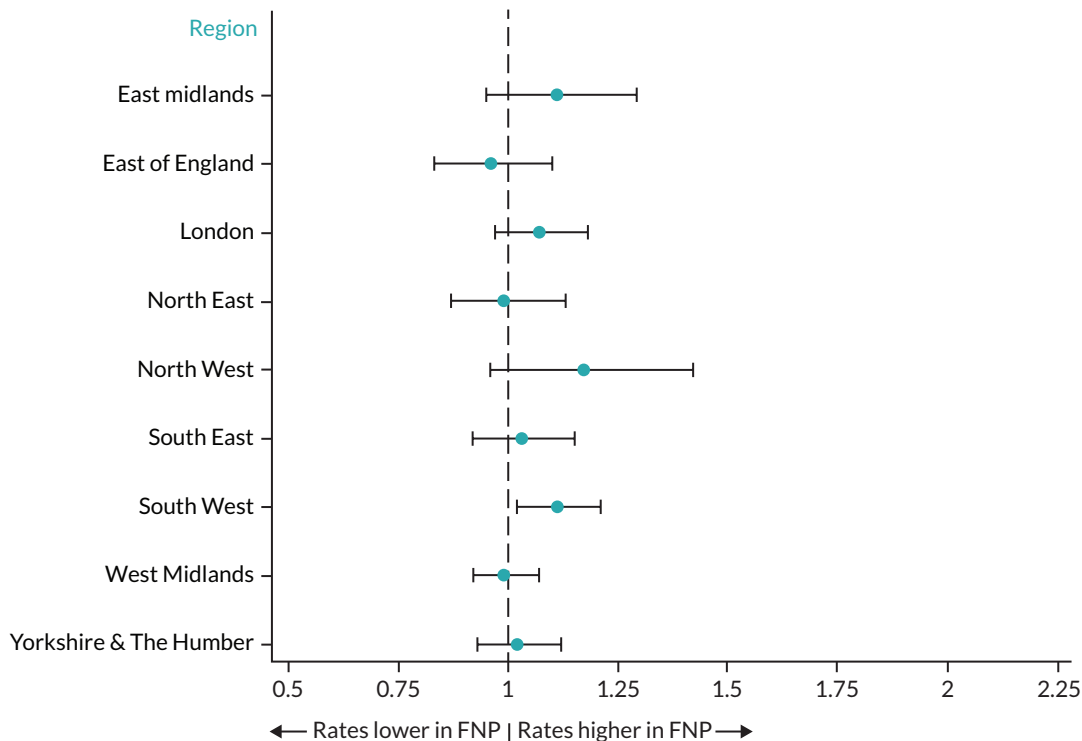
**TABLE 50** Relative risks and 95% CIs for domains of a Good Level of Development (school readiness) comparing mothers enrolled in the FNP vs. mothers who were not enrolled, for mothers aged 13–19 in the propensity-score-matched cohort

	N (%) in mothers enrolled in FNP (treated)	N (%) in mothers never enrolled in FNP (untreated)	Adjusted <sup>a</sup> RR (95% CI)
<b>Child developmental/educational outcomes – within 7 years (Births between April 2010 and March 2012)</b>			
<i>Total with information on nursery attendance</i>	4090	4040	
Nursery attendance <sup>e</sup>	3915 (89.8)	3870 (88.8)	1.00 (0.99 to 1.01)
<i>Total with information on EYFSP</i>	3990	3955	
Good Level of Development (school readiness)	2295 (57.5)	2190 (55.4)	1.05 (1.00 to 1.09)
GLD: Communication and Language	2980 (74.7)	2930 (74.1)	1.01 (0.98 to 1.04)
GLD: Physical Development	3290 (82.5)	3220 (81.4)	1.01 (0.99 to 1.04)
GLD: Personal, Social and Emotional Development	3095 (77.6)	3040 (76.9)	1.01 (0.99 to 1.03)
GLD: Literacy	2400 (60.2)	2290 (57.9)	1.04 (1.00 to 1.08)
GLD: Maths	2655 (66.5)	2570 (65.0)	1.03 (0.99 to 1.07)

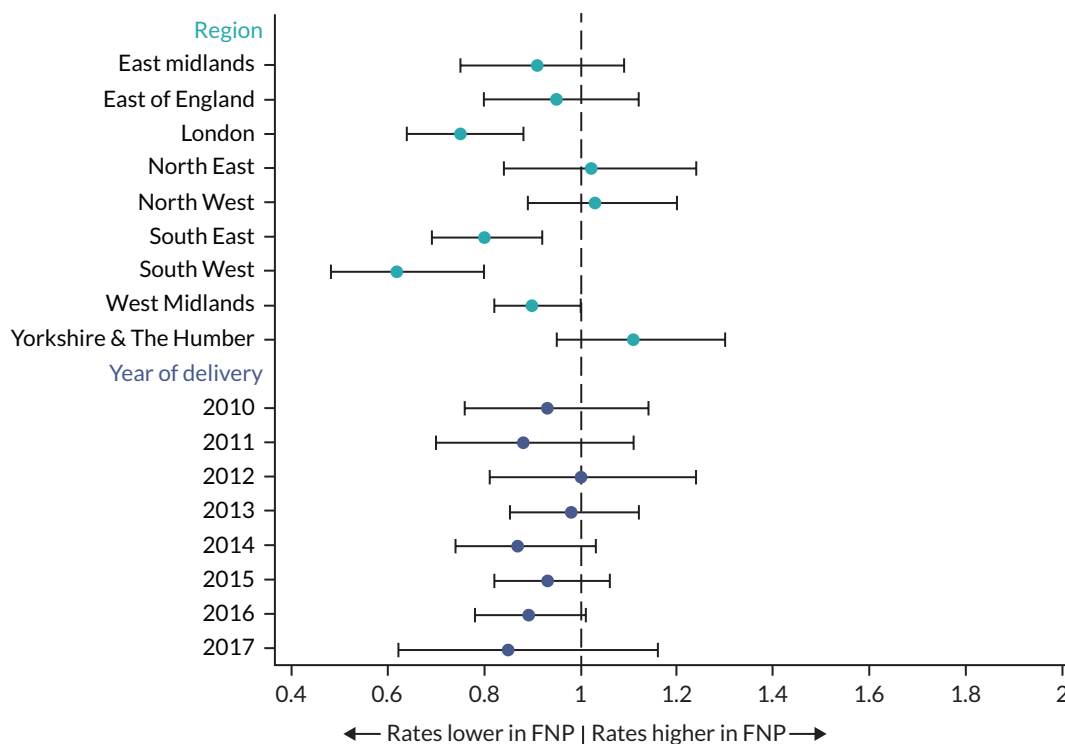
a Variables for adjustment were those from [Table 3](#); Different models were adjusted for different variables according to the model of best fit.



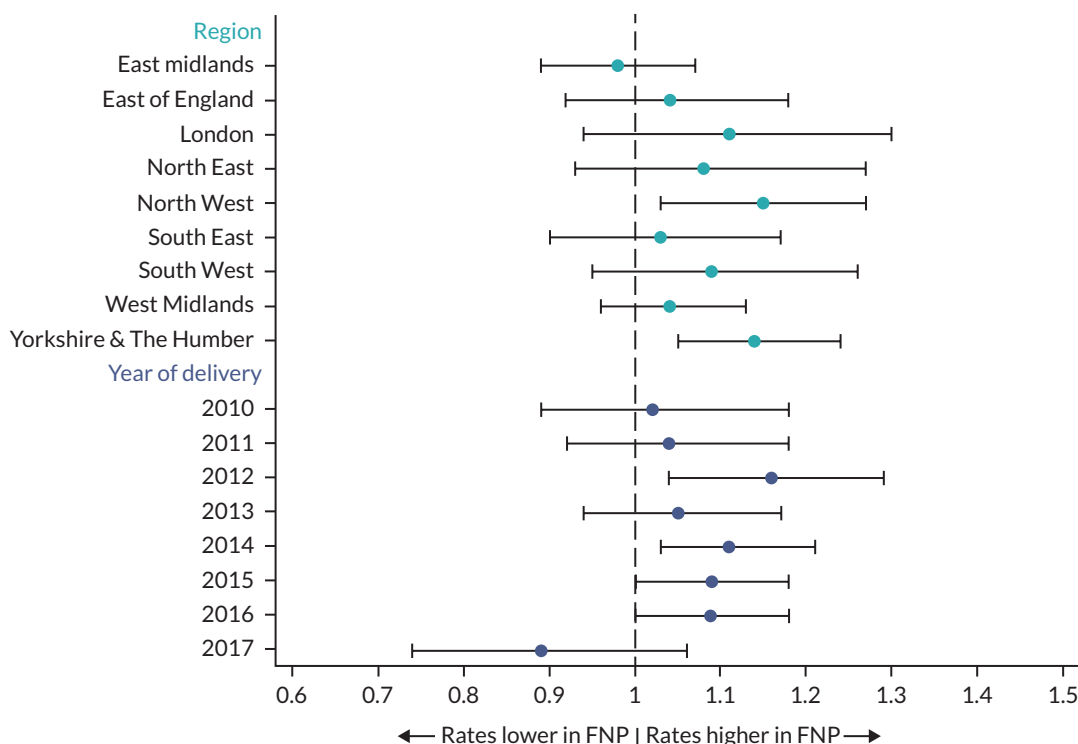
**FIGURE 31** Subgroup analysis: child unplanned admissions for maltreatment/injury up to age 2: adjusted RRs and 95% CIs comparing mothers enrolled in the FNP vs. mothers who were not enrolled, for mothers aged 13–19 and giving birth in an area in which FNP was offered at the time of pregnancy by region and year of delivery.



**FIGURE 32** Subgroup analysis: Good Level of Development (school readiness): adjusted RRs and 95% CIs comparing mothers enrolled in the FNP vs. mothers who were not enrolled, for mothers aged 13–19 and giving birth in an area in which FNP was offered at the time of pregnancy by region and year of delivery. Note: A Good Level of Development was not stratified by year of delivery since it was only assessed for children who were born before 2013 (to allow long enough follow-up).



**FIGURE 33** Subgroup analysis: subsequent births within 18 months: adjusted RRs and 95% CIs comparing mothers enrolled in the FNP vs. mothers who were not enrolled, for mothers aged 13–19 and giving birth in an area in which FNP was offered at the time of pregnancy by region and year of delivery.



**FIGURE 34** Subgroup analysis: maternal unplanned admissions for any diagnosis in the 2 years following delivery: adjusted RRs and 95% CIs comparing mothers enrolled in the FNP vs. mothers who were not enrolled, for mothers aged 13–19 and giving birth in an area in which FNP was offered at the time of pregnancy by region and year of delivery.



**TABLE 51** Subgroup analysis: RRs comparing outcomes for mothers enrolled in the FNP vs. mothers who were never enrolled in the FNP, living within an area in which FNP was offered at the time of pregnancy, within each subgroup

Subgroup	Child unplanned admission for maltreatment or injury within 2 years	Good level of development (school readiness) at age 5	Subsequent delivery within 18 months	Maternal admission for any diagnosis within 2 years
	RR (95% CI)	RR (95% CI)	RR (95% CI)	RR (95% CI)
Maternal age				
13–15	1.31 (0.93 to 1.84)	1.13 (0.94 to 1.36)	1.20 (0.74 to 1.95)	1.00 (0.84 to 1.20)
16–17	1.11 (0.99 to 1.25)	1.09 (1.01 to 1.18)	0.88 (0.80 to 0.96)	1.14 (1.06 to 1.22)
18–19	1.15 (1.03 to 1.27)	1.00 (0.95 to 1.05)	0.96 (0.88 to 1.05)	1.06 (1.01 to 1.11)
20–21	1.30 (1.04 to 1.61)	1.13 (1.00 to 1.28)	0.83 (0.71 to 0.97)	1.01 (0.91 to 1.12)
Ethnicity				
White	1.15 (1.06 to 1.24)	1.04 (0.99 to 1.09)	0.95 (0.89 to 1.01)	1.08 (1.04 to 1.13)
South Asian	1.04 (0.50 to 2.18)	1.34 (0.84 to 2.14)	1.08 (0.77 to 1.53)	1.08 (0.84 to 1.39)
Black	0.91 (0.62 to 1.33)	1.05 (0.93 to 1.20)	0.71 (0.53 to 0.94)	1.04 (0.84 to 1.30)
Mixed/other	1.36 (0.97 to 1.92)	0.96 (0.81 to 1.14)	0.70 (0.54 to 0.91)	1.02 (0.85 to 1.24)
Unknown	1.50 (0.95 to 2.36)	1.50 (1.02 to 2.22)	0.60 (0.39 to 0.90)	0.97 (0.67 to 1.40)
Area-level deprivation				
Least deprived	1.21 (0.88 to 1.65)	1.01 (0.85 to 1.20)	0.66 (0.48 to 0.92)	0.95 (0.81 to 1.12)
2	1.21 (0.94 to 1.57)	1.01 (0.85 to 1.20)	0.93 (0.72 to 1.19)	1.14 (1.00 to 1.31)
3	1.36 (1.12 to 1.65)	0.98 (0.88 to 1.08)	0.84 (0.71 to 1.00)	1.14 (1.03 to 1.25)
4	1.05 (0.89 to 1.25)	1.03 (0.95 to 1.11)	0.90 (0.80 to 1.01)	1.06 (0.98 to 1.14)
Most deprived	1.15 (1.02 to 1.28)	1.08 (1.03 to 1.13)	0.97 (0.90 to 1.04)	1.07 (1.02 to 1.12)
Social care contact				
No CPP or CLA	1.20 (1.11 to 1.30)	1.03 (0.98 to 1.08)	0.93 (0.87 to 1.00)	1.09 (1.04 to 1.14)
CPP or CLA	0.99 (0.83 to 1.18)	1.11 (0.94 to 1.31)	0.89 (0.78 to 1.02)	0.99 (0.90 to 1.09)
History of adversity				
No	1.13 (1.05 to 1.22)	1.05 (1.01 to 1.09)	0.93 (0.87 to 0.99)	1.08 (1.03 to 1.13)
Yes	1.44 (1.18 to 1.75)	1.03 (0.87 to 1.20)	0.82 (0.68 to 0.99)	1.06 (0.96 to 1.16)
History of mental health conditions				
No	1.14 (1.06 to 1.23)	1.05 (1.01 to 1.10)	0.93 (0.87 to 0.99)	1.08 (1.04 to 1.13)
Yes	1.34 (1.05 to 1.71)	0.96 (0.69 to 1.33)	0.79 (0.61 to 1.04)	1.01 (0.90 to 1.13)
Child sex				
Male	1.14 (1.04 to 1.25)	1.08 (1.00 to 1.16)	0.92 (0.85 to 1.00)	1.11 (1.05 to 1.17)
Female	1.18 (1.06 to 1.31)	1.03 (0.99 to 1.07)	0.92 (0.85 to 1.01)	1.04 (0.99 to 1.1)
Region				
East Midlands	1.18 (1.06 to 1.31)	1.11 (0.95 to 1.29)	0.91 (0.75 to 1.09)	0.98 (0.89 to 1.07)
East of England	1.41 (1.06 to 1.89)	0.96 (0.83 to 1.10)	0.95 (0.80 to 1.12)	1.04 (0.92 to 1.18)
London	1.04 (0.80 to 1.34)	1.07 (0.97 to 1.18)	0.75 (0.64 to 0.88)	1.11 (0.94 to 1.30)

**TABLE 51** Subgroup analysis – RRs comparing outcomes for mothers enrolled in the FNP vs. mothers who were never enrolled in the FNP, living within an area in which FNP was offered at the time of pregnancy, within each subgroup (*continued*)

Subgroup	Child unplanned admission for maltreatment or injury within 2 years RR (95% CI)	Good level of development (school readiness) at age 5 RR (95% CI)	Subsequent delivery within 18 months RR (95% CI)	Maternal admission for any diagnosis within 2 years RR (95% CI)
North East	1.08 (0.89 to 1.32)	0.99 (0.87 to 1.13)	1.02 (0.84 to 1.24)	1.08 (0.93 to 1.27)
North West	1.15 (1.01 to 1.32)	1.17 (0.96 to 1.42)	1.03 (0.89 to 1.02)	1.15 (1.03 to 1.27)
South East	1.27 (1.00 to 1.61)	1.03 (0.92 to 1.15)	0.80 (0.69 to 0.92)	1.03 (0.90 to 1.17)
South West	1.09 (0.80 to 1.49)	1.11 (1.02 to 1.21)	0.62 (0.48 to 0.80)	1.09 (0.95 to 1.26)
West Midlands	1.18 (0.96 to 1.46)	0.99 (0.92 to 1.07)	0.90 (0.82 to 1.00)	1.04 (0.96 to 1.13)
Yorkshire and The Humber	1.07 (0.92 to 1.25)	1.02 (0.93 to 1.12)	1.11 (0.95 to 1.30)	1.14 (1.05 to 1.24)
Year of delivery				
2010	1.24 (0.97 to 1.59)		0.93 (0.76 to 1.14)	1.02 (0.89 to 1.18)
2011	1.19 (0.97 to 1.46)		0.88 (0.70 to 1.11)	1.04 (0.92 to 1.18)
2012	1.10 (0.88 to 1.39)		1.00 (0.81 to 1.24)	1.16 (1.04 to 1.29)
2013	1.14 (0.98 to 1.34)		0.98 (0.85 to 1.12)	1.05 (0.94 to 1.17)
2014	1.25 (1.03 to 1.53)		0.87 (0.74 to 1.03)	1.11 (1.03 to 1.21)
2015	1.12 (0.97 to 1.29)		0.93 (0.82 to 1.06)	1.09 (1.00 to 1.18)
2016	1.17 (0.99 to 1.37)		0.89 (0.78 to 1.01)	1.09 (1.00 to 1.18)
2017	0.91 (0.60 to 1.37)		0.85 (0.62 to 1.16)	0.89 (0.74 to 1.06)

**Note**

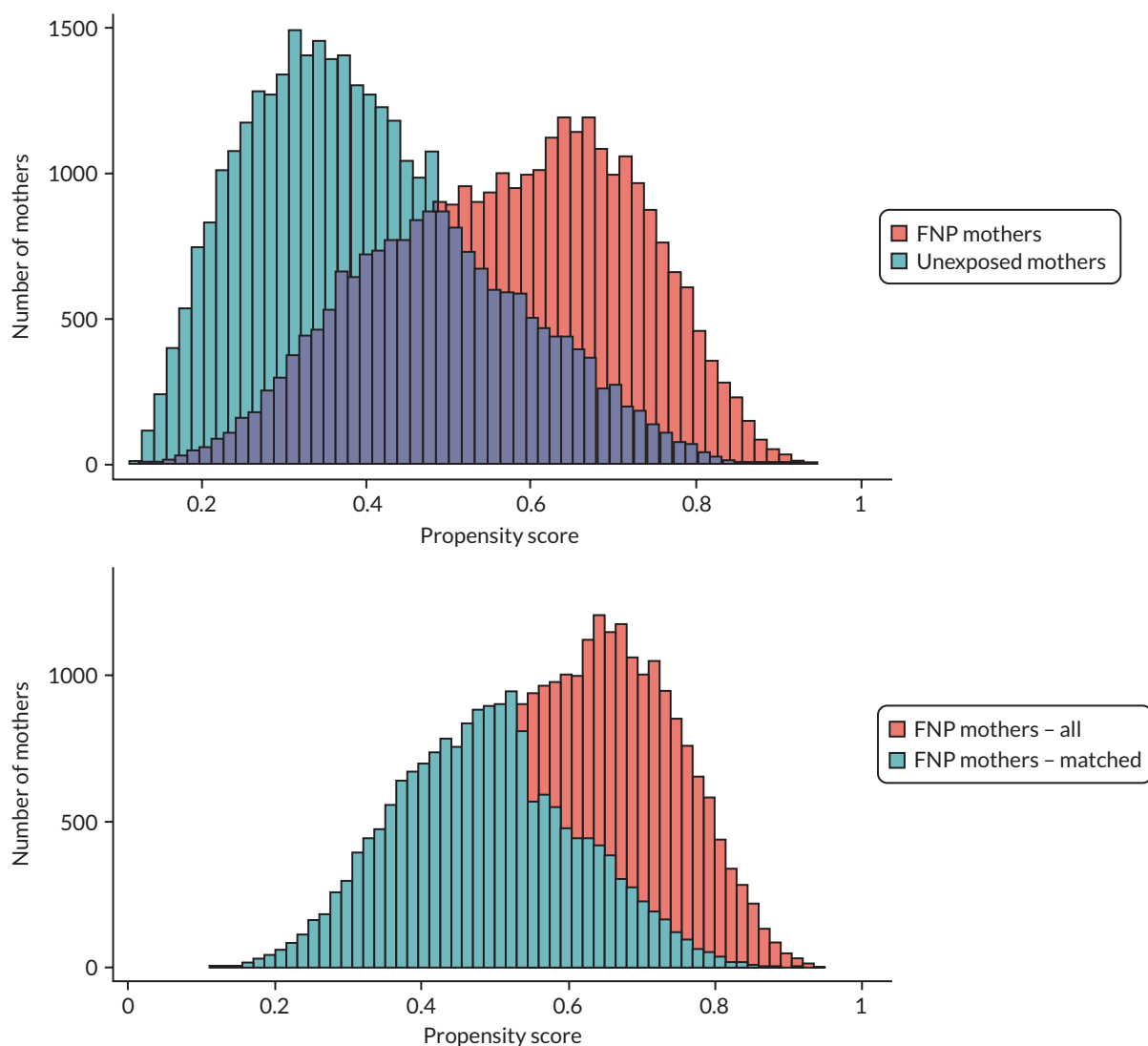
A Good Level of Development was not stratified by year of delivery since it was only assessed for children who were born before 2013 (to allow long-enough follow-up).



## Appendix 9 Additional information on Objective 2: sensitivity analyses

*Sensitivity analysis 1:* Propensity score matching within the same LA but in different time periods, allowing matches to eligible families before FNP was offered in that LA.

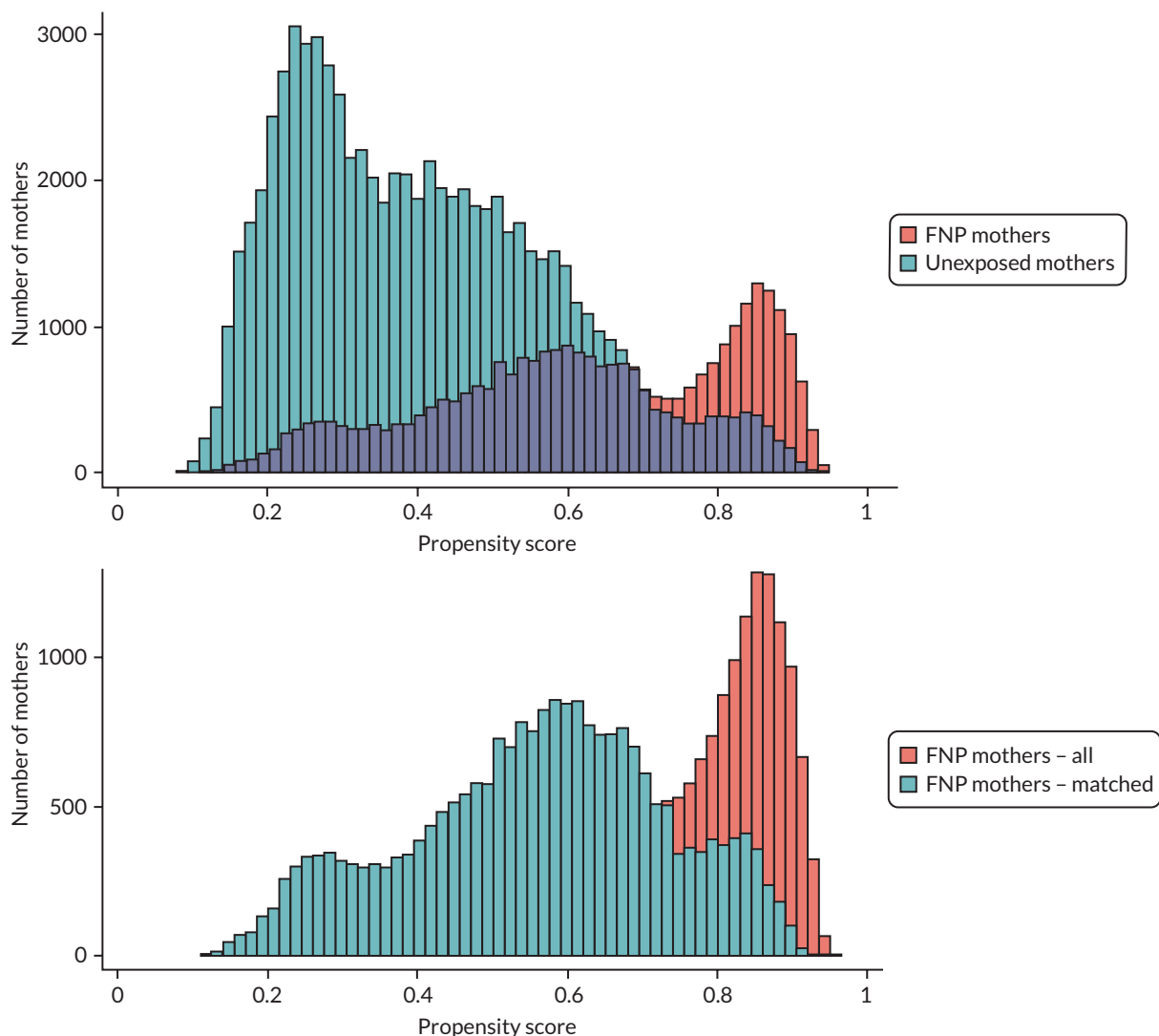
For this sensitivity analysis, fewer FNP mothers could be matched using the main analysis strategy of matching without replacement. For births outcomes (births between April 2010 and March 2019, 18,400/31,100 FNP mothers (59.2%) could be matched. For outcomes in the 2 years after birth (births between April 2010 and March 2017), 14,935/25,545 (58.5%) of FNP mothers could be matched. For outcomes in the 7 years after birth, 3375/4365 (77.3%) of FNP mothers could be matched. Due to this lower coverage, we also present results using a matching with replacement strategy. When this strategy was used, 100% of mothers in each cohort could be matched.



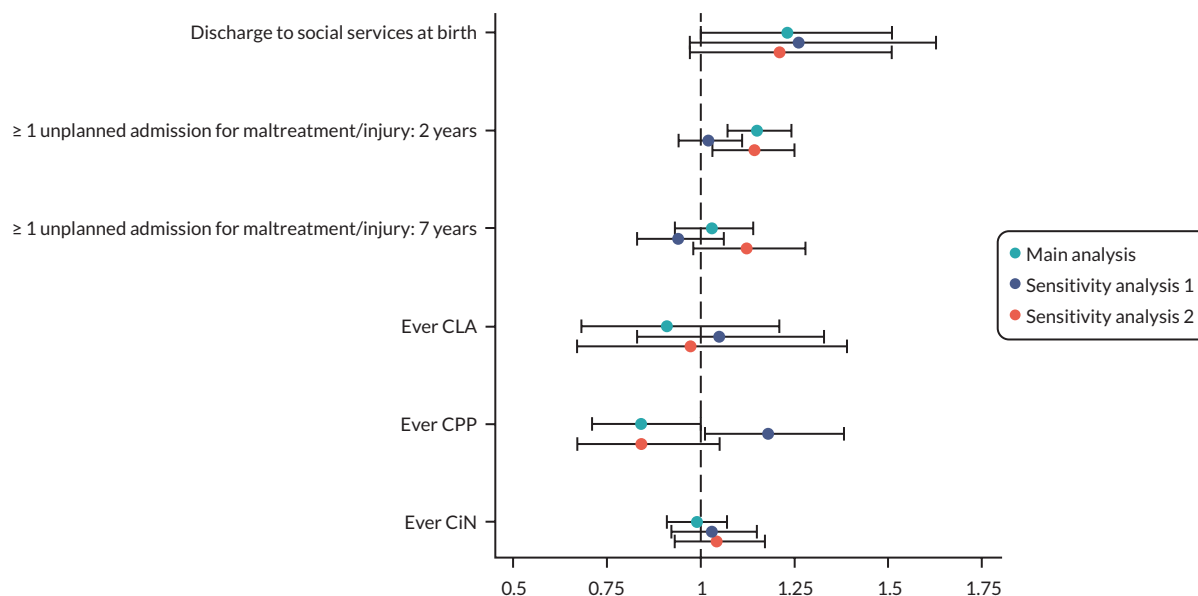
**FIGURE 35** Sensitivity analysis 1: overlap in the distribution of propensity scores between mothers who were and were not enrolled in FNP (top figure); propensity scores for all FNP mothers and those included in the matched without replacement cohort for analysis (bottom figure).

*Sensitivity analysis 2: Propensity score matching within the same time period but in different LAs, allowing matches to eligible families in LAs that did not offer FNP.*

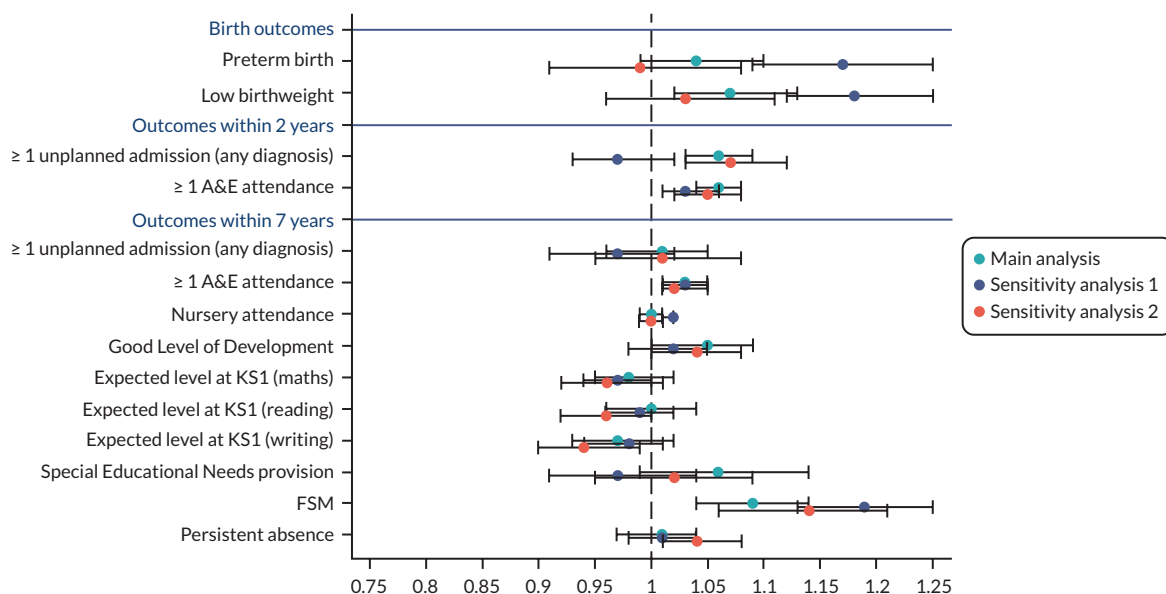
For this sensitivity analysis, fewer FNP mothers could be matched using the main analysis strategy of matching without replacement (but more were matched than in Sensitivity analysis 2). For births outcomes (births between April 2010 and March 2019), 23,405/31,100 FNP mothers (75.3%) could be matched. For outcomes in the 2 years after birth (births between April 2010 and March 2017), 17,985/25,545 (70.4%) of FNP mothers could be matched. For outcomes in the 7 years after birth, 4360/4365 (99.9%) of FNP mothers could be matched.



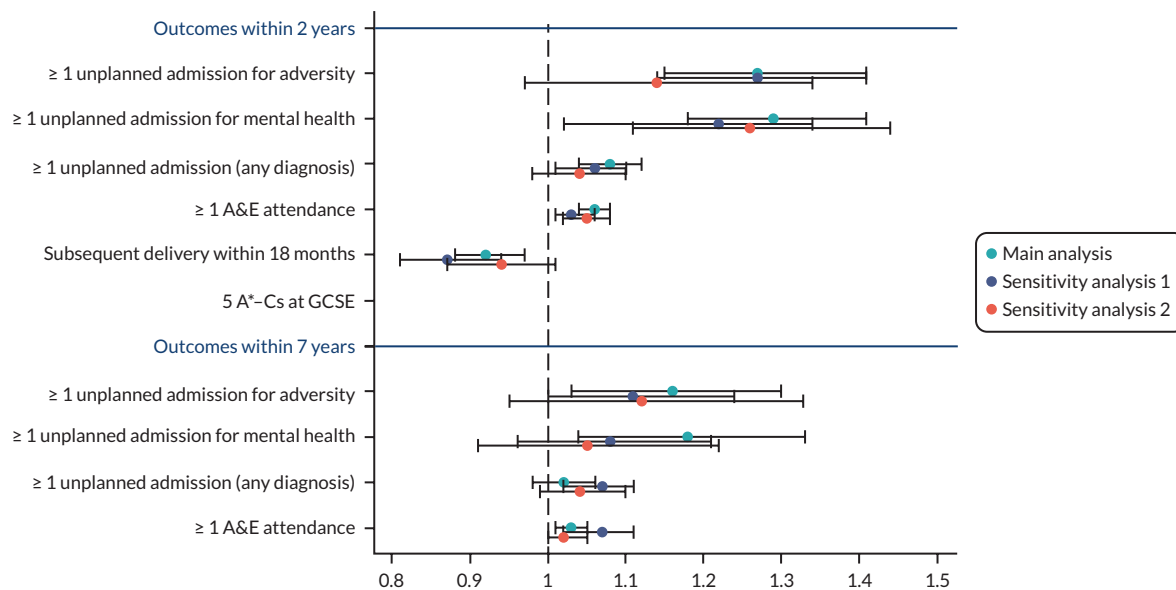
**FIGURE 36** Sensitivity analysis 2: overlap in the distribution of propensity scores between mothers who were and were not enrolled in FNP (top figure); propensity scores for all FNP mothers and those included in the matched without replacement cohort for analysis (bottom figure).



**FIGURE 37** Sensitivity analyses: RRs and 95% CIs for indicators of child maltreatment comparing mothers enrolled in the FNP vs. mothers who were not enrolled, for mothers aged 13–19 in the propensity-score-matched cohort. Note: Sensitivity analysis 1 compares mothers within the same LA but in different time periods; sensitivity analysis 2 compares mothers within the same time period but in different LAs.



**FIGURE 38** Sensitivity analyses: RRs and 95% CIs for child health, developmental and education outcomes comparing mothers enrolled in the FNP vs. mothers who were not enrolled, for mothers aged 13–19 in the propensity-score-matched cohort. Note: Sensitivity analysis 1 compares mothers within the same LA but in different time periods; sensitivity analysis 2 compares mothers within the same time period but in different LAs. KS1, Key Stage 1.



**FIGURE 39** Sensitivity analyses: RRs and 95% CIs for maternal outcomes comparing mothers enrolled in the FNP vs. mothers who were not enrolled, for mothers aged 13–19 in the propensity-score-matched cohort. Note: Sensitivity analysis 1 compares mothers within the same LA but in different time periods; sensitivity analysis 2 compares mothers within the same time period but in different LAs.

**TABLE 52** Sensitivity analyses: RRs and 95% CIs for indicators of child maltreatment comparing mothers enrolled in the FNP vs. mothers who were not enrolled, for mothers aged 13–19 in the propensity-score-matched cohort

	Sensitivity analysis 1		Sensitivity analysis 2	
	Propensity score matching without replacement	Propensity score matching with replacement	Propensity score matching without replacement	Propensity score matching with replacement
<b>Birth outcomes</b> (Births between April 2010 and March 2019)				
Discharge to social services	1.26 (0.97 to 1.63)	1.12 (0.92 to 1.35)	1.21 (0.97 to 1.51)	1.31 (0.93 to 1.85)
<b>Child outcomes – within 2 years</b> (Births between April 2010 and March 2017)				
≥ 1 unplanned admission for maltreatment or injury	1.02 (0.94 to 1.11)	0.98 (0.91 to 1.05)	1.14 (1.03 to 1.25)	1.05 (0.92 to 1.20)
<b>Child outcomes – within 7 years</b> (Births between April 2010 and March 2012)				
≥ 1 unplanned admission for maltreatment or injury	0.94 (0.83 to 1.06)	0.93 (0.84 to 1.04)	1.12 (0.98 to 1.28)	1.12 (0.98 to 1.27)
CLA	1.05 (0.83 to 1.33)	0.92 (0.73 to 1.14)	0.97 (0.67 to 1.39)	0.96 (0.65 to 1.4-)
CPP	1.18 (1.01 to 1.38)	1.24 (1.05 to 1.47)	0.84 (0.67 to 1.05)	0.77 (0.61 to 0.97)
CiN referral	1.03 (0.92 to 1.15)	1.02 (0.92 to 1.13)	1.04 (0.93 to 1.17)	1.00 (0.89 to 1.13)

**Note**  
Sensitivity analysis 1 compares mothers within the same LA but in different time periods; sensitivity analysis 2 compares mothers within the same time period but in different LAs.

**TABLE 53** Sensitivity analyses: RRs and 95% CIs for child health, developmental and education outcomes comparing mothers enrolled in the FNP vs. mothers who were not enrolled, for mothers aged 13–19 in the propensity-score-matched cohort

	Sensitivity analysis 1		Sensitivity analysis 2	
	Propensity score matching without replacement	Propensity score matching with replacement	Propensity score matching without replacement	Propensity score matching with replacement
Birth outcomes (Births between April 2010 and March 2019)				
Preterm birth (< 37 weeks of gestation)	1.17 (1.09 to 1.25)	1.18 (1.12 to 1.26)	0.99 (0.91 to 1.08)	1.08 (0.98 to 1.20)
Low birthweight (< 2500 g)	1.18 (1.12 to 1.25)	1.21 (1.17 to 1.26)	1.03 (0.96 to 1.11)	1.11 (1.01 to 1.22)
Child health outcomes – within 2 years (Births between April 2010 and March 2017)				
≥ 1 unplanned admission for any diagnosis	0.97 (0.93 to 1.02)	0.96 (0.92 to 1.00)	1.07 (1.03 to 1.12)	1.05 (1.00 to 1.10)
≥ 1 A&E attendance	1.06 (1.04 to 1.08)	1.07 (1.05 to 1.08)	1.04 (1.02 to 1.06)	1.04 (1.02 to 1.06)
≥ 1 outpatient referral	1.09 (1.05 to 1.12)	1.10 (1.06 to 1.14)	1.05 (1.01 to 1.09)	1.04 (1.00 to 1.08)
Did not attend ≥ 1 outpatient appointment	1.08 (1.02 to 1.14)	1.06 (1.02 to 1.11)	1.12 (1.05 to 1.20)	1.08 (0.99 to 1.17)
Child health outcomes – within 7 years (Births between April 2010 and March 2012)				
≥ 1 unplanned admission for any diagnosis	0.97 (0.91 to 1.02)	0.97 (0.92 to 1.03)	1.01 (0.95 to 1.08)	1.02 (0.95 to 1.09)
≥ 1 A&E attendance	1.03 (1.01 to 1.05)	1.04 (1.02 to 1.05)	1.03 (1.01 to 1.05)	1.03 (1.00 to 1.05)
≥ 1 outpatient referral	1.02 (0.99 to 1.05)	1.03 (1.00 to 1.05)	1.06 (1.02 to 1.10)	1.06 (1.02 to 1.10)
Did not attend ≥ 1 outpatient appointment	1.00 (0.94 to 1.06)	0.98 (0.93 to 1.03)	1.10 (1.03 to 1.18)	1.10 (1.02 to 1.18)
Child developmental/educational outcomes – within 7 years (Births between April 2010 and March 2012)				
Nursery attendance	1.02 (1.01 to 1.02)	1.01 (1.01 to 1.02)	1.00 (0.99 to 1.01)	1.00 (0.99 to 1.01)
Good Level of Development (school readiness)	1.02 (0.98 to 1.05)	1.01 (0.98 to 1.05)	1.04 (1.00 to 1.08)	1.05 (1.00 to 1.09)
Expected levels at KS1 (maths)	0.97 (0.94 to 1.00)	0.97 (0.94 to 1.00)	0.96 (0.92 to 1.01)	0.97 (0.93 to 1.01)
Expected levels at KS1 (reading)	0.99 (0.96 to 1.02)	0.98 (0.95 to 1.00)	0.96 (0.92 to 1.00)	0.97 (0.93 to 1.01)
Expected levels at KS1 (writing)	0.98 (0.94 to 1.01)	0.96 (0.92 to 0.99)	0.94 (0.90 to 0.99)	0.95 (0.90 to 1.00)

continued



**TABLE 53** Sensitivity analyses: RRs and 95% CIs for child health, developmental and education outcomes comparing mothers enrolled in the FNP vs. mothers who were not enrolled, for mothers aged 13–19 in the propensity-score-matched cohort (*continued*)

	Sensitivity analysis 1		Sensitivity analysis 2	
	Propensity score matching without replacement	Propensity score matching with replacement	Propensity score matching without replacement	Propensity score matching with replacement
SEN provision	0.97 (0.91 to 1.04)	0.97 (0.92 to 1.02)	1.02 (0.95 to 1.09)	1.00 (0.93 to 1.09)
FSM	1.19 (1.13 to 1.25)	1.12 (1.07 to 1.19)	1.14 (1.06 to 1.21)	1.14 (1.07 to 1.22)
Persistent absence	1.01 (0.98 to 1.04)	1.00 (0.98 to 1.03)	1.04 (1.01 to 1.08)	1.04 (1.00 to 1.08)

KS1, Key Stage 1.

**Note**  
Sensitivity analysis 1 compares mothers within the same LA but in different time periods; sensitivity analysis 2 compares mothers within the same time period but in different LAs.

**TABLE 54** Sensitivity analyses: RRs and 95% CIs for maternal outcomes comparing mothers enrolled in the FNP vs. mothers who were not enrolled, for mothers aged 13–19 in the propensity-score-matched cohort

	Sensitivity analysis 1		Sensitivity analysis 2	
	Propensity score matching without replacement	Propensity score matching with replacement	Propensity score matching without replacement	Propensity score matching with replacement
Maternal outcomes – 2 years (Births between April 2010 and March 2017)				
≥ 1 unplanned admission for adversity-related diagnoses	1.27 (1.14 to 1.41)	1.28 (1.16 to 1.41)	1.14 (0.97 to 1.34)	1.08 (0.86 to 1.35)
≥ 1 unplanned admission for mental health-related diagnoses	1.22 (1.02 to 1.34)	1.20 (1.09 to 1.31)	1.26 (1.11 to 1.44)	1.19 (1.01 to 1.40)
≥ 1 unplanned admission for any diagnosis	1.06 (1.01 to 1.10)	1.03 (0.99 to 1.07)	1.04 (0.98 to 1.10)	1.03 (0.96 to 1.10)
≥ 1 A&E attendance	1.03 (1.01 to 1.06)	1.05 (1.03 to 1.07)	1.05 (1.02 to 1.08)	1.06 (1.03 to 1.09)
Subsequent delivery within 18 months	0.87 (0.81 to 0.94)	0.91 (0.86 to 0.96)	0.94 (0.87 to 1.01)	0.96 (0.88 to 1.06)
5 A*–Cs at GCSE level	1.16 (1.02 to 1.32)	1.20 (1.09 to 1.32)	0.93 (0.81 to 1.08)	1.03 (0.86 to 1.22)
School attendance	1.05 (0.99 to 1.11)	1.01 (0.97 to 1.04)	1.04 (0.97 to 1.11)	1.01 (0.94 to 1.09)
Maternal outcomes – 7 years (Births between April 2010 and March 2012)				
≥ 1 unplanned admissions for adversity-related diagnoses	1.11 (1.00 to 1.24)	1.14 (1.03 to 1.26)	1.12 (0.95 to 1.33)	1.15 (0.96 to 1.37)
≥ 1 unplanned admission for mental health-related diagnoses	1.08 (0.96 to 1.21)	1.08 (0.97 to 1.19)	1.05 (0.91 to 1.22)	1.06 (0.91 to 1.24)
≥ 1 unplanned admission for any diagnosis	1.07 (1.02 to 1.11)	1.06 (1.02 to 1.11)	1.04 (0.99 to 1.10)	1.05 (0.99 to 1.10)
≥ 1 A&E attendance	1.03 (1.01 to 1.05)	1.02 (1.01 to 1.04)	1.02 (1.00 to 1.05)	1.02 (1.00 to 1.05)

**Note**  
Sensitivity analysis 1 compares mothers within the same LA but in different time periods; sensitivity analysis 2 compares mothers within the same time period but in different LAs.

**TABLE 55** Sensitivity analyses of modelling approaches: RRs comparing Indicators of child maltreatment for mothers enrolled in the FNP vs. mothers who were never enrolled in the FNP, living within an area in which FNP was offered at the time of pregnancy

	<b>Main analysis: propensity score matched with doubly robust analysis</b>	<b>Sensitivity analysis: multivariable regression</b>	<b>Sensitivity analysis: propensity score matched comparison</b>
	<b>RR (95% CI)</b>	<b>RR (95% CI)</b>	<b>RR (95% CI)</b>
<b>Birth outcomes</b> (Births between April 2010 and March 2019)			
Discharge to social services	1.23 (1.00 to 1.51)	1.17 (0.98 to 1.39)	1.20 (0.96 to 1.49)
<b>Child outcomes – within 2 years</b> (Births between April 2010 and March 2017)			
≥ 1 unplanned admission for maltreatment or injury	1.15 (1.07 to 1.24)	1.20 (1.14 to 1.27)	1.15 (1.07 to 1.24)
<b>Child outcomes – within 7 years</b> (Births between April 2010 and March 2012)			
≥ 1 unplanned admission for maltreatment or injury	1.03 (0.93 to 1.14)	1.11 (1.03 to 1.20)	1.03 (0.93 to 1.14)
CLA	0.91 (0.68 to 1.21)	1.01 (0.84 to 1.21)	0.91 (0.67 to 1.22)
CPP	0.84 (0.71 to 1.00)	0.96 (0.80 to 1.15)	0.84 (0.71 to 1.00)
CiN referral	0.99 (0.91 to 1.07)	1.02 (0.94 to 1.11)	0.99 (0.91 to 1.07)

**TABLE 56** Sensitivity analyses of modelling approaches: RRs comparing child health, developmental and educational outcomes for mothers enrolled in the FNP vs. mothers who were never enrolled in the FNP, living within an area in which FNP was offered at the time of pregnancy

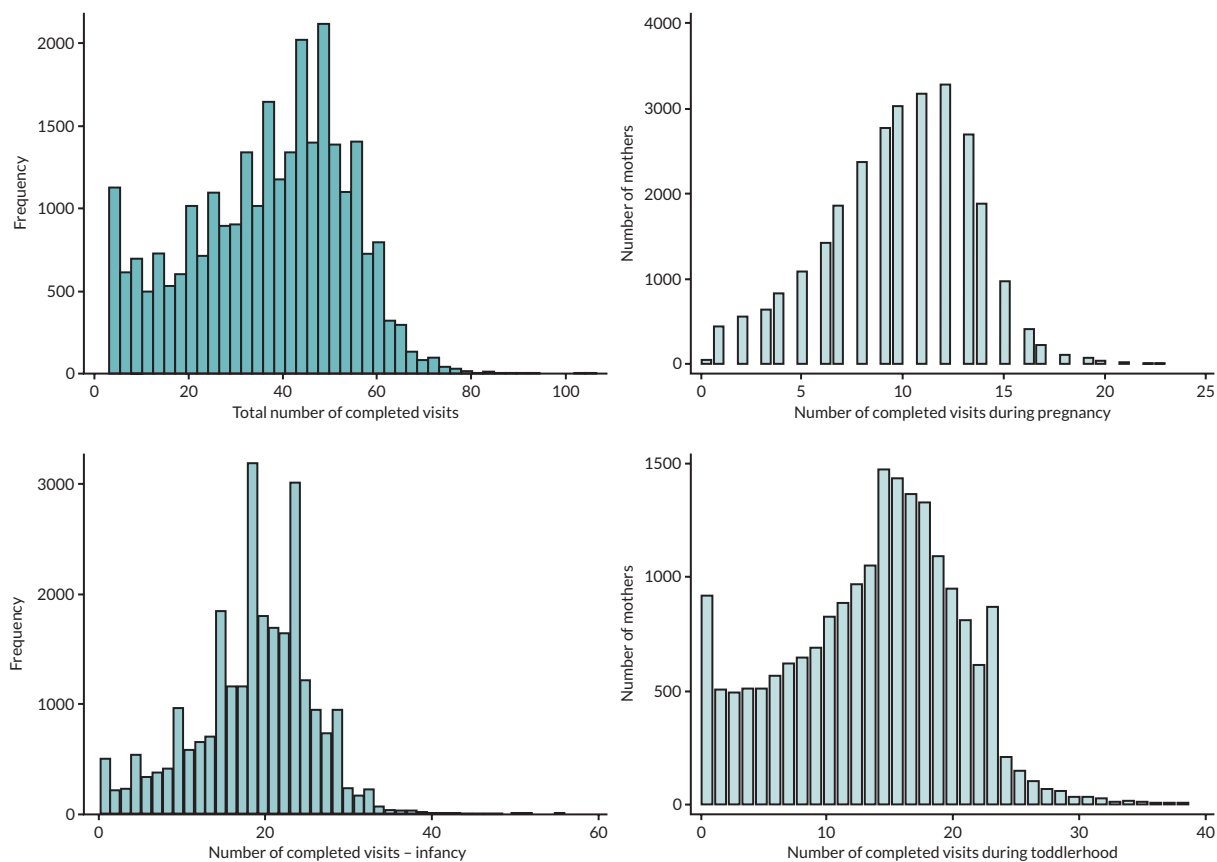
	<b>Main analysis: propensity score matched with doubly robust analysis</b>	<b>Sensitivity analysis: multivariable regression</b>	<b>Sensitivity analysis: propensity score matched comparison</b>
	<b>RR (95% CI)</b>	<b>RR (95% CI)</b>	<b>RR (95% CI)</b>
<b>Birth outcomes</b> (Births between April 2010 and March 2019)			
Preterm birth	1.04 (0.99 to 1.10)	1.04 (0.99 to 1.09)	1.05 (0.99 to 1.10)
Low birthweight	1.07 (1.02 to 1.13)	1.07 (1.02 to 1.12)	1.08 (1.03 to 1.14)
<b>Child outcomes – within 2 years</b> (Births between April 2010 and March 2017)			
≥ 1 unplanned admission for any diagnosis	1.06 (1.03 to 1.09)	1.07 (1.05 to 1.1)	1.06 (1.04 to 1.09)
≥ 1 A&E attendance	1.04 (1.03 to 1.05)	1.04 (1.03 to 1.05)	1.04 (1.03 to 1.05)
≥ 1 referral to outpatient department	1.10 (1.07 to 1.12)	1.09 (1.07 to 1.11)	1.10 (1.08 to 1.12)
≥ 1 did not attend outpatient appointment	1.11 (1.06 to 1.15)	1.10 (1.06 to 1.13)	1.11 (1.06 to 1.16)
<b>Child outcomes – within 7 years</b> (Births between April 2010 and March 2012)			
≥ 1 unplanned admission for any diagnosis	1.01 (0.96 to 1.05)	1.05 (1.01 to 1.09)	1.00 (0.96 to 1.05)
≥ 1 A&E attendance	1.03 (1.02 to 1.05)	1.04 (1.03 to 1.06)	1.03 (1.02 to 1.05)
≥ 1 referral to outpatient department	1.05 (1.02 to 1.08)	1.06 (1.04 to 1.09)	1.05 (1.02 to 1.08)
≥ 1 did not attend outpatient appointment	1.07 (1.01 to 1.12)	1.08 (1.03 to 1.13)	1.07 (1.02 to 1.13)
Nursery attendance	1.00 (0.99 to 1.01)	1.00 (1.00 to 1.01)	1.00 (0.99 to 1.01)
Good Level of Development (school readiness)	1.05 (1.00 to 1.09)	1.02 (0.99 to 1.06)	1.04 (0.99 to 1.09)
Expected levels at KS1 (maths)	0.98 (0.95 to 1.02)	0.96 (0.93 to 0.98)	0.98 (0.95 to 1.02)
Expected levels at KS1 (reading)	1.00 (0.96 to 1.04)	0.96 (0.94 to 0.99)	1.00 (0.97 to 1.04)
Expected levels at KS1 (writing)	0.97 (0.93 to 1.02)	0.93 (0.91 to 0.97)	0.97 (0.93 to 1.02)
SEN provision	1.06 (0.99 to 1.14)	1.07 (1.01 to 1.13)	1.07 (1.00 to 1.14)
FSM	1.09 (1.04 to 1.14)	1.08 (1.04 to 1.13)	1.10 (1.05 to 1.15)
Persistent absence	1.01 (0.97 to 1.04)	1.00 (0.98 to 1.03)	1.02 (0.98 to 1.06)

**TABLE 57** Sensitivity analyses of modelling approaches: RRs maternal outcomes for mothers enrolled in the FNP vs. mothers who were never enrolled in the FNP, living within an area in which FNP was offered at the time of pregnancy

	<b>Main analysis: propensity score matched with doubly robust analysis</b>	<b>Sensitivity analysis: multivariable regression</b>	<b>Sensitivity analysis: propensity score matched comparison</b>
	<b>RR (95% CI)</b>	<b>RR (95% CI)</b>	<b>RR (95% CI)</b>
<b>Maternal outcomes – 2 years</b>			
<b>Births between April 2010 and March 2017</b>			
≥ 1 unplanned admission for adversity-related diagnoses	1.27 (1.15 to 1.41)	1.30 (1.18 to 1.43)	1.26 (1.13 to 1.40)
≥ 1 unplanned admission for mental health-related diagnoses	1.29 (1.18 to 1.41)	1.35 (1.25 to 1.46)	1.29 (1.17 to 1.42)
≥ 1 unplanned admission for any diagnosis	1.08 (1.04 to 1.12)	1.07 (1.04 to 1.11)	1.08 (1.03 to 1.13)
≥ 1 A&E attendance	1.06 (1.04 to 1.08)	1.06 (1.04 to 1.07)	1.06 (1.04 to 1.08)
Subsequent delivery within 18 months	0.92 (0.88 to 0.97)	0.92 (0.88 to 0.97)	0.92 (0.86 to 0.98)
5 A*-Cs at GCSE level	1.12 (0.96 to 1.29)	1.02 (0.90 to 1.16)	1.25 (1.06 to 1.48)
School attendance	0.96 (0.92 to 1.01)	1.00 (0.96 to 1.05)	0.96 (0.91 to 1.00)
<b>Maternal outcomes – 7 years</b>			
<b>Births between April 2010 and March 2012</b>			
≥ 1 unplanned admission for adversity-related diagnoses	1.16 (1.03 to 1.30)	1.17 (1.05 to 1.30)	1.16 (1.01 to 1.32)
≥ 1 unplanned admission for mental health-related diagnoses	1.18 (1.04 to 1.33)	1.15 (1.04 to 1.26)	1.15 (1.00 to 1.32)
≥ 1 unplanned admission for any diagnosis	1.02 (0.98 to 1.06)	1.05 (1.01 to 1.09)	1.02 (0.97 to 1.06)
≥ 1 A&E attendance	1.03 (1.01 to 1.05)	1.04 (1.02 to 1.05)	1.03 (1.01 to 1.05)
<b>KS1, Key Stage 1.</b>			



## Appendix 10 Additional results for Objective 3



**FIGURE 40** Distribution of visits for each stage of the programme, for mothers giving birth between April 2010 and January 2018 aged 13–19 at LMP.

**TABLE 58** Maternal characteristics and number of visits and fidelity targets at each stage of the programme, for mothers giving birth between April 2010 and January 2018 aged 13–19 at LMP, according to HES and NPD data at enrolment

	Full programme				Pregnancy stage (up to birth)			Infancy stage (0–1 year)			Toddlerhood stage (1–2 years)		
	Total		Number of visits		Total	Met 80% target		Total	Met 65% target		Total	Met 60% target	
	N	%	Mean (SD)	Median (IQR)	N	N	%	N	N	%	N	N	%
<b>Total</b>	28,150	100	35.9 (17.0)	38 (24–49)	28,150	16,695	59.3	25,900	16,940	65.4	19,990	12,115	60.6
<b>Maternal age at delivery (years)</b>													
13–15	1345	4.8	39.0 (16.7)	41 (28–51)	1345	935	69.5	1285	940	73.2	985	610	61.9
16–17	9485	33.7	36.5 (17.1)	39 (24–49)	9485	5765	60.8	8785	5760	65.6	6785	4110	60.6
18–19	14,150	50.3	35.5 (17.1)	38 (23–48)	14,150	8190	57.9	12,910	8380	64.9	10,030	6095	60.8
20 <sup>a</sup>	3170	11.3	35.0 (16.8)	37 (22–48)	3170	1805	56.9	2925	1860	63.6	2185	1300	59.5

continued

**TABLE 58** Maternal characteristics and number of visits and fidelity targets at each stage of the programme, for mothers giving birth between April 2010 and January 2018 aged 13–19 at LMP, according to HES and NPD data at enrolment (*continued*)

	Full programme				Pregnancy stage (up to birth)			Infancy stage (0–1 year)			Toddlerhood stage (1–2 years)		
	Total		Number of visits		Total	Met 80% target		Total	Met 65% target		Total	Met 60% target	
	N	%	Mean (SD)	Median (IQR)	N	N	%	N	N	%	N	N	%
Ethnicity													
White	23,820	84.6	36.3 (17.1)	39 (24–49)	23,820	14,140	59.4	21,875	14,510	66.3	16,925	10,435	61.7
South Asian	605	2.2	34.4 (16.7)	37 (23–48)	605	355	58.7	550	355	64.5	415	260	62.7
Black	1305	4.6	34.0 (15.9)	35 (22–46)	1305	755	57.9	1235	695	56.3	955	475	49.7
Mixed/ other	1505	5.3	33.6 (16.3)	36 (22–46)	1505	900	59.8	1395	835	59.9	1040	550	52.9
Unknown	915	3.3	35.3 (17.3)	38 (23–48)	915	540	59.0	845	545	64.5	650	395	60.8
Area-level deprivation													
Least deprived	1250	4.4	36.5 (17.1)	39 (24–50)	1250	790	63.2	1140	775	68.0	905	555	61.3
2	2035	7.2	36.8 (16.7)	39 (25–49)	2035	1250	61.4	1870	1285	68.7	1475	880	59.7
3	3710	13.2	36.1 (17.2)	39 (24–49)	3710	2250	60.6	3370	2275	67.5	2620	1600	61.1
4	7060	25.1	35.9 (17.0)	38 (24–49)	7060	4150	58.8	6530	4270	65.4	4975	2990	60.1
Most deprived	13,945	49.5	35.7 (17.1)	38 (23–49)	13,945	8150	58.4	12,845	8230	64.1	9900	5995	60.6
Unknown	155	0.6	38.5 (17.7)	41 (27–51)	155	105	67.7	145	105	72.4	115	90	78.3
Region													
East Midlands	2470	8.8	35.0 (16.7)	38 (23–47)	2470	1330	53.8	2240	1395	62.3	1840	960	52.2
East of England	2305	8.2	36.0 (17.6)	38 (23–50)	2305	1335	57.9	2115	1470	69.5	1570	995	63.4
London	4115	14.6	33.1 (17.1)	34 (20–47)	4115	2295	55.8	3775	2225	58.9	2790	1585	56.8
North East	2060	7.3	34.9 (17.9)	37 (23–48)	2060	1200	58.3	1800	1205	66.9	1360	825	60.7
North West	4305	15.3	37.7 (17.1)	41 (27–50)	4305	2715	63.1	3965	2615	66.0	3190	2005	62.9
South East	4055	14.4	38.2 (17.3)	42 (26–51)	4055	2590	63.9	3750	2720	72.5	2970	2025	68.2
South West	1590	5.6	36.1 (16.3)	38 (25–48)	1590	855	53.8	1480	930	62.8	1165	675	57.9
West Midlands	3665	13.0	34.8 (15.9)	37 (23–47)	3665	2145	58.5	3435	2155	62.7	2555	1410	55.2
Yorkshire and The Humber	3585	12.7	36.8 (16.8)	39 (25–49)	3585	2220	61.9	3345	2225	66.5	2545	1635	64.2

**TABLE 58** Maternal characteristics and number of visits and fidelity targets at each stage of the programme, for mothers giving birth between April 2010 and January 2018 aged 13–19 at LMP, according to HES and NPD data at enrolment (*continued*)

	Full programme				Pregnancy stage (up to birth)			Infancy stage (0–1 year)			Toddlerhood stage (1–2 years)		
	Total		Number of visits		Total	Met 80% target		Total	Met 65% target		Total	Met 60% target	
	N	%	Mean (SD)	Median (IQR)	N	N	%	N	N	%	N	N	%
	Year of delivery												
2010	2045	7.3	37.6 (17.0)	41 (28–49)	2045	1025	50.1	1900	1035	54.5	1665	1105	66.4
2011	1860	6.6	35.8 (17.7)	40 (23–49)	1860	870	46.8	1690	1000	59.2	1405	905	64.4
2012	2865	10.2	39.9 (17.5)	44 (30–52)	2865	1865	65.1	2650	1865	70.4	2265	1510	66.7
2013	4070	14.5	40.0 (17.1)	44 (30–52)	4070	2585	63.5	3765	2665	70.8	3210	2170	67.6
2014	3590	12.8	38.0 (16.6)	41 (28–50)	3590	2190	61.0	3330	2255	67.7	2755	1715	62.3
2015	5110	18.2	35.0 (16.2)	37 (24–47)	5110	3175	62.1	4720	3180	67.4	3470	1935	55.8
2016	5260	18.7	31.9 (16.3)	32 (19–45)	5260	3105	59.0	4805	3065	63.8	3070	1665	54.2
2017	3145	11.2	32.5 (16.5)	34 (19–45)	3145	1775	56.4	2865	1785	62.3	2020	1060	52.5
2018	200	0.7	28.7 (16.3)	30 (14–41)	200	100	50.0	175	95	54.3	125	50	40.0
Season of birth													
January– March	6675	23.7	35.6 (17.0)	38 (23–48)	6675	3870	58.0	6100	4060	66.6	4675	2830	60.5
April–June	7020	24.9	36.0 (16.9)	39 (24–49)	7020	4125	58.8	6505	4235	65.1	5020	3025	60.3
July– September	7245	25.7	36.1 (17.2)	39 (24–49)	7245	4355	60.1	6655	4295	64.5	5175	3165	61.2
October– December	7210	25.6	36.1 (17.0)	38 (24–49)	7210	4340	60.2	6645	4345	65.4	5115	3090	60.4
History of admissions within 2 years prior to 20 weeks of pregnancy													
Adversity	2010	7.1	37.3 (17.9)	39 (24–50)	2010	1290	64.2	1855	1310	70.6	1375	880	64.0
Violence	175	0.6	35.4 (18.9)	36 (20–48)	175	105	60.0	160	110	68.8	110	70	63.6
Self-harm	1540	5.5	37.4 (17.8)	40 (25–50)	1540	1000	64.9	1425	1005	70.5	1050	680	64.8
Substance misuse	1810	6.4	37.4 (17.9)	39 (25–50)	1810	1160	64.1	1670	1185	71.0	1245	800	64.3
Mental health (exc. self-harm/ substance misuse)	1160	4.1	37.6 (17.5)	41 (25–50)	1160	775	66.8	1080	805	74.5	790	520	65.8
Mental health (any)	2325	8.3	37.4 (17.8)	40 (25–50)	2325	1505	64.7	2150	1530	71.2	1600	1030	64.4
Chronic condition (any, exc. mental health)	3600	12.8	36.9 (17.6)	39 (24–50)	3600	2245	62.4	3330	2305	69.2	2485	1575	63.4
A&E visits	19,635	69.7	35.9 (17.3)	38 (23–49)	19,635	11,615	59.2	18,020	11,850	65.8	13,760	8390	61.0

*continued*



**TABLE 58** Maternal characteristics and number of visits and fidelity targets at each stage of the programme, for mothers giving birth between April 2010 and January 2018 aged 13–19 at LMP, according to FNP information data at enrolment (*continued*)

	Full programme					Pregnancy stage (up to birth)			Infancy stage (0–1 year)			Toddlerhood stage (1–2 years)		
	Total		Number of visits			Total	Met 80% target		Total	Met 65% target		Total	Met 60% target	
	N	%	Mean (SD)	Median (IQR)		N	N	%	N	N	%	N	N	%
Repeated A&E visits (≥ 4)	6050	21.5	36.0 (17.7)	38 (23–49)	6050	3600	59.5	5545	3740	67.4	4095	2585	63.1	
Did not attend at least one outpatient appointment	9775	37.7	35.2 (17.4)	37 (22–48)	9775	5720	58.5	8900	5855	65.8	6635	4025	60.7	
Gestational age at antenatal booking appointment														
Before 10 weeks	7505	26.7	36.7 (17.1)	39 (25–50)	7505	4335	57.8	6890	4565	66.3	5385	3330	61.8	
10–20 weeks	10,450	37.1	36.5 (16.9)	39 (25–49)	10,450	6315	60.4	9735	6340	65.1	7575	4535	59.9	
20 weeks or more	1705	6.1	33.5 (17.4)	36 (20–47)	1705	1065	62.5	1525	995	65.2	1150	700	60.9	
Unknown	8490	30.2	35.1 (17.0)	38 (23–48)	8490	4980	58.7	7745	5040	65.1	5880	3550	60.4	
Linked to NPD														
Linked to NPD	25,185	89.5	36.1 (17.0)	39 (24–49)	25,185	14,930	59.3	23,185	15,210	65.6	17,970	10,900	60.7	
Not linked to NPD	2835	10.1	34.5 (17.4)	37 (21–48)	2835	1685	59.4	2590	1650	63.7	1915	1155	60.3	
Not linked to NPD census	135	0.5	36.6 (17.7)	39 (23–49)	135	75	55.6	125	80	64.0	105	60	57.1	
Social care and educational characteristics before 20 weeks of pregnancy														
Ever in care	2760	11.0	35.5 (17.9)	37 (21–49)	2760	1770	64.1	2545	1810	71.1	1715	1100	64.1	
Ever had recorded CPP	1530	6.1	35.0 (17.8)	35 (22–49)	1530	980	64.1	1405	1000	71.2	945	580	61.4	
Ever recorded as having SEN	15,275	60.7	36.3 (17.2)	39 (24–49)	15,275	9195	60.2	14,095	9430	66.9	10,720	6625	61.8	
Ever recorded as having FSM	16,490	65.5	36.0 (17.2)	38 (23–49)	16,490	9850	59.7	15,190	9995	65.8	11,555	7090	61.4	
Ever in bottom IDACI decile	10,235	40.6	35.3 (17.0)	37 (23–48)	10,235	5995	58.6	9405	5945	63.2	7150	4290	60.0	
Ever excluded, in PRU or alternative provision	9395	37.3	35.4 (17.4)	38 (22–49)	9395	5460	58.1	8615	5585	64.8	6495	3910	60.2	

**TABLE 58** Maternal characteristics and number of visits and fidelity targets at each stage of the programme, for mothers giving birth between April 2010 and January 2018 aged 13–19 at LMP, according to HES and NPD data at enrolment (*continued*)

	Full programme				Pregnancy stage (up to birth)			Infancy stage (0–1 year)			Toddlerhood stage (1–2 years)		
	Total		Number of visits		Total	Met 80% target		Total	Met 65% target		Total	Met 60% target	
	N	%	Mean (SD)	Median (IQR)	N	N	%	N	N	%	N	N	%
	Ever recorded as persistently absent in a term	13,745	54.6	36.5 (17.0)	39 (25–49)	13,745	8190	59.6	12,705	8300	65.3	9905	5980
GCSE attainment for those eligible	3620	17.0	36.1 (16.4)	39 (25–49)	3620	2195	60.6	3315	2215	66.8	2655	1535	57.8
KS2 Maths (achieved expected levels)	12,590	50.0	36.1 (16.8)	39 (24–49)	12,590	7415	58.9	11,570	7545	65.2	9135	5425	59.4
KS2 English (achieved expected levels)	15,550	61.7	35.9 (16.8)	38 (24–48)	15,550	9100	58.5	14,300	9235	64.6	11,220	6610	58.9

IQR, interquartile range; KS2, Key Stage 2.  
a Includes only mothers aged 19 at LMP.

**Note**

Numbers have been rounded to the nearest 5 and cell sizes < 10 have been suppressed, in accordance with NHS Digital's and DfE's statistical disclosure rules for subnational analyses.

**TABLE 59** Nurse and participant characteristics and number of visits and fidelity targets at each stage of the programme, for mothers giving birth between April 2010 and January 2018 aged 13–19 at LMP, according to FNP information at enrolment

	Full programme				Pregnancy (up to birth)			Infancy (0–1 year)			Toddlerhood (1–2 years)		
	Total		Number of visits		Total	Met 80% target		Total	Met 65% target		Total	Met 60% target	
	N	%	Mean (SD)	Median (IQR)	N	N	%	N	N	%	N	N	%
	<b>Total</b>	<b>28,150</b>	<b>100</b>	<b>35.9 (17.0)</b>	<b>38 (24–49)</b>	<b>28,150</b>	<b>16,695</b>	<b>59.3</b>	<b>25,900</b>	<b>16,940</b>	<b>65.4</b>	<b>19,990</b>	<b>12,115</b>
English as primary language													
No	1350	4.8	33.5 (15.7)	35 (22–46)	1350	835	61.9	1275	765	60.0	920	490	53.3
Yes	26,035	92.5	36.9 (16.5)	39 (25–49)	26,035	15,785	60.6	24,375	16,090	66.0	18,935	11,550	61.0
Unknown	770	2.7	7.7 (11.9)	2 (1–7)	770	75	9.7	250	85	34.0	135	75	55.6

continued

**TABLE 59** Nurse and participant characteristics and number of visits and fidelity targets at each stage of the programme, for mothers giving birth between April 2010 and January 2018 aged 13–19 at LMP, according to FNP information at enrolment (*continued*)

	Full programme				Pregnancy (up to birth)			Infancy (0–1 year)			Toddlerhood (1–2 years)		
	Total		Number of visits		Total	Met 80% target		Total	Met 65% target		Total	Met 60% target	
	N	%	Mean (SD)	Median (IQR)	N	N	%	N	N	%	N	N	%
Marital status													
Married/ civil partnership	730	2.6	34.5 (16.4)	37 (23–47)	730	425	58.2	670	425	63.4	495	310	62.6
Co-habiting	5325	18.9	36.8 (16.6)	39 (25–49)	5325	3245	60.9	4975	3330	66.9	3830	2370	61.9
Separated/ divorced	65	0.2	34.8 (16.6)	37 (28–48)	65	35	53.8	60	35	58.3	45	25	55.6
Single – never married	21,255	75.5	36.8 (16.5)	39 (25–49)	21,255	12,905	60.7	19,940	13,060	65.5	15,475	9335	60.3
Unknown	780	2.8	8.1 (12.4)	2 (1–8)	780	80	10.3	260	90	34.6	140	80	57.1
% of visits with partner present													
0	6825	24.2	27.1 (17.8)	27 (11–42)	6825	3375	49.5	5520	3045	55.2	3545	1840	51.9
1–9.9	5745	20.4	41.7 (13.1)	43 (33–51)	5745	3715	64.7	5730	3990	69.6	4930	3015	61.2
10–29.9	7295	25.9	39.2 (15.1)	41 (29–50)	7295	4505	61.8	7105	4795	67.5	5745	3570	62.1
30–49.9	3965	14.1	39.1 (15.6)	41 (29–50)	3965	2510	63.3	3810	2565	67.3	3050	1910	62.6
≥ 50	4290	15.2	33.9 (18.9)	37 (18–49)	4290	2590	60.4	3725	2550	68.5	2685	1745	65.0
% of visits with parent present													
0	8880	31.5	29.0 (18.1)	29 (13–44)	8880	4505	50.7	7350	4300	58.5	4945	2735	55.3
1–9.9	8175	29	42.3 (13.0)	43 (34–51)	8175	5355	65.5	8160	5800	71.1	7065	4485	63.5
10–29.9	6515	23.1	38.4 (15.6)	40 (28–50)	6515	4095	62.9	6305	4135	65.6	4970	3040	61.2
30–49.9	2380	8.5	37.0 (16.7)	40 (24–50)	2380	1505	63.2	2245	1500	66.8	1680	1055	62.8
≥ 50	2165	7.7	32.1 (19.1)	34 (16–48)	2165	1235	57.0	1820	1205	66.2	1290	760	58.9
Living arrangement													
Alone	15,085	53.6	37.0 (16.2)	39 (26–49)	15,085	9135	60.6	14,185	9195	64.8	11,225	6710	59.8
Foster carers/ group home/other	5440	19.3	36.4 (16.5)	39 (24–49)	5440	3310	60.8	5070	3355	66.2	3885	2375	61.1
Mother (with or without partner)	2770	9.8	36.8 (17.0)	39 (24–49)	2770	1680	60.6	2570	1705	66.3	1970	1210	61.4
Partner (with/ without others, not mother)	1620	5.8	36.5 (17.0)	38 (25–49)	1620	930	57.4	1520	975	64.1	1170	720	61.5

**TABLE 59** Nurse and participant characteristics and number of visits and fidelity targets at each stage of the programme, for mothers giving birth between April 2010 and January 2018 aged 13–19 at LMP, according to FNP information at enrolment (*continued*)

	Full programme				Pregnancy (up to birth)			Infancy (0–1 year)			Toddlerhood (1–2 years)		
	Total		Number of visits		Total	Met 80% target		Total	Met 65% target		Total	Met 60% target	
	N	%	Mean (SD)	Median (IQR)	N	N	%	N	N	%	N	N	%
Relatives/ other adults	2470	8.8	36.0 (17.4)	37 (22–49)	2470	1565	63.4	2305	1625	70.5	1605	1020	63.6
Unknown	770	2.7	7.7 (11.9)	2 (1–7)	770	75	9.7	250	85	34.0	135	75	55.6
Housing type													
Owned	5245	18.6	37.2 (15.7)	40 (27–49)	5245	3150	60.1	4915	3310	67.3	3960	2345	59.2
Rented: private	6000	21.3	35.7 (16.7)	38 (23–48)	6000	3525	58.8	5585	3525	63.1	4250	2545	59.9
Rented: housing association	3600	12.8	38.1 (16.4)	40 (27–50)	3600	2270	63.1	3410	2280	66.9	2730	1660	60.8
Rented: council	9410	33.4	37.0 (16.5)	40 (25–49)	9410	5765	61.3	8840	5770	65.3	6865	4245	61.8
Unknown	3895	13.8	30.0 (19.6)	31 (13–46)	3895	1985	51.0	3155	2055	65.1	2185	1320	60.4
Number of benefits received at enrolment													
0	15,475	55	36.5 (16.3)	39 (25–49)	15,475	9475	61.2	14,480	9500	65.6	11,215	6590	58.8
1	6050	21.5	36.8 (16.8)	40 (25–49)	6050	3580	59.2	5660	3690	65.2	4390	2785	63.4
2	3365	12	36.9 (16.8)	39 (25–50)	3365	2050	60.9	3160	2110	66.8	2425	1485	61.2
3	1835	6.5	37.2 (17.0)	40 (25–50)	1835	1115	60.8	1725	1145	66.4	1325	855	64.5
4 +	650	2.3	37.7 (16.9)	41 (26–50)	650	400	61.5	615	410	66.7	490	320	65.3
Unknown	775	2.7	7.8 (12.0)	2 (1–7)	775	75	9.7	255	85	33.3	135	80	59.3
CiN status at enrolment													
No	25,745	91.4	36.6 (16.4)	39 (25–49)	25,745	15,430	59.9	24,085	15,685	65.1	18,735	11,300	60.3
Yes	1635	5.8	39.1 (17.4)	41 (26–52)	1635	1185	72.5	1560	1170	75.0	1120	735	65.6
Unknown	775	2.7	7.9 (12.1)	2 (1–7)	775	80	10.3	255	85	33.3	135	80	59.3
CPP at enrolment													
No	26,595	94.5	36.6 (16.5)	39 (25–49)	26,595	16,025	60.3	24,895	16,255	65.3	19,350	11,695	60.4
Yes	780	2.8	38.8 (17.8)	40 (24–52)	780	590	75.6	755	595	78.8	500	340	68.0
Unknown	775	2.7	7.9 (12.1)	2 (1–7)	775	80	10.3	255	85	33.3	135	80	59.3
Alcohol or drug use in the 2 weeks prior to enrolment													
No	25,655	91.1	37.0 (16.2)	39 (25–49)	25,655	15,745	61.4	24,230	15,940	65.8	18,755	11,350	60.5
Yes	1380	4.9	38.3 (16.4)	40 (27–50)	1380	855	62.0	1325	860	64.9	1025	640	62.4
Unknown	1120	4	8.5 (13.5)	2 (1–7)	1120	95	8.5	345	135	39.1	210	125	59.5
Characteristics of family nurses													
Nurse age (years)													
21–29	1235	4.4	35.3 (15.6)	37 (24–47)	1235	710	57.5	1185	705	59.5	895	485	54.2

continued

**TABLE 59** Nurse and participant characteristics and number of visits and fidelity targets at each stage of the programme, for mothers giving birth between April 2010 and January 2018 aged 13–19 at LMP, according to FNP information at enrolment (*continued*)

	Full programme				Pregnancy (up to birth)			Infancy (0–1 year)			Toddlerhood (1–2 years)		
	Total		Number of visits		Total	Met 80% target		Total	Met 65% target		Total	Met 60% target	
	N	%	Mean (SD)	Median (IQR)	N	N	%	N	N	%	N	N	%
30–39	4525	16.1	35.3 (16.2)	37 (24–47)	4525	2675	59.1	4220	2695	63.9	3190	1810	56.7
40–49	10,580	37.6	36.1 (16.7)	39 (24–49)	10,580	6395	60.4	9760	6405	65.6	7530	4515	60.0
50–59	5935	21.1	36.7 (17.2)	39 (25–50)	5935	3545	59.7	5505	3715	67.5	4270	2640	61.8
60–69	305	1.1	31.6 (16.0)	35 (18–44)	305	125	41.0	275	145	52.7	215	105	48.8
Unknown	5570	19.8	35.8 (18.4)	39 (22–50)	5570	3245	58.3	4955	3275	66.1	3895	2560	65.7
Nurse gender													
Male	200	0.7	33.0 (17.4)	33 (19–48)	200	110	55.0	180	125	69.4	120	80	66.7
Female	22,380	79.5	36.0 (16.7)	38 (24–49)	22,380	13,335	59.6	20,770	13,540	65.2	15,970	9480	59.4
Unknown	5570	19.8	35.8 (18.4)	39 (22–50)	5570	3245	58.3	4955	3275	66.1	3895	2560	65.7
Nurse ethnicity													
White	20,770	73.8	36.4 (16.6)	39 (25–49)	20,770	12,480	60.1	19,285	12,735	66.0	14,935	8925	59.8
South Asian	210	0.7	29.8 (16.5)	30 (16–44)	210	110	52.4	185	120	64.9	120	70	58.3
Black	1335	4.7	30.9 (16.4)	32 (18–43)	1335	705	52.8	1215	670	55.1	840	460	54.8
Mixed/other	270	1	33.3 (15.4)	32 (22–45)	270	155	57.4	260	145	55.8	195	100	51.3
Unknown	5570	19.8	35.8 (18.4)	39 (22–50)	5570	3245	58.3	4955	3275	66.1	3895	2560	65.7
Nurse health visiting qualification													
No BSc HV	9805	34.8	35.8 (16.6)	38 (24–48)	9805	5780	58.9	9125	5865	64.3	6945	4120	59.3
BSc HV	12,780	45.4	36.1 (16.7)	38 (24–49)	12,780	7665	60.0	11,820	7800	66.0	9145	5440	59.5
Unknown	5570	19.8	35.8 (18.4)	39 (22–50)	5570	3245	58.3	4955	3275	66.1	3895	2560	65.7

IQR, interquartile range.

**Note**

Numbers have been rounded to the nearest 5 and cell sizes &lt; 10 have been suppressed, in accordance with NHS Digital's and DfE's statistical disclosure rules for subnational analyses.

**TABLE 60** Pregnancy targets: year of delivery and fidelity targets in pregnancy, for mothers giving birth between April 2010 and January 2018 aged 13–19 at LMP

	N mothers (% of all mothers)	N who met pregnancy target (% of group)	Adjusted RR (95% CI) <sup>a</sup>
<b>Total</b>	<b>27,360 (100)</b>	<b>16,610 (60.7)</b>	–
Year of delivery			
2010	1970 (7.2)	1020 (51.8)	1.00 (ref)
2011	1785 (6.5)	865 (48.5)	0.92 (0.84 to 1.01)
2012	2795 (10.2)	1855 (66.4)	1.22 (1.10 to 1.35)
2013	3975 (14.5)	2575 (64.8)	1.18 (1.07 to 1.31)
2014	3515 (12.8)	2185 (62.2)	1.14 (1.03 to 1.27)

**TABLE 60** Pregnancy targets: year of delivery and fidelity targets in pregnancy, for mothers giving birth between April 2010 and January 2018 aged 13–19 at LMP (*continued*)

	<b>N mothers (% of all mothers)</b>	<b>N who met pregnancy target (% of group)</b>	<b>Adjusted RR (95% CI)<sup>a</sup></b>
2015	4975 (18.2)	3165 (63.6)	1.17 (1.05 to 1.30)
2016	5130 (18.8)	3085 (60.1)	1.09 (0.97 to 1.22)
2017	3025 (11.1)	1760 (58.2)	1.05 (0.93 to 1.17)
2018	190 (0.7)	100 (52.6)	0.95 (0.81 to 1.13)

a Variables for adjustment were those from [Table 3](#); Different models were adjusted for different variables according to the model of best fit.

**TABLE 61** Infancy targets: year of delivery and fidelity targets in infancy, for mothers giving birth between April 2010 and January 2018 aged 13–19 at LMP

	<b>N mothers (% of all mothers)</b>	<b>N who met infancy target (% of group)</b>	<b>Adjusted RR (95% CI)<sup>a</sup></b>
<b>Total</b>	<b>25,635 (100)</b>	<b>16,845 (65.7)</b>	-
Year of delivery			
2010	1865 (7.3)	1030 (55.2)	1.00 (ref)
2011	1670 (6.5)	990 (59.3)	1.07 (1.00 to 1.15)
2012	2630 (10.3)	1855 (70.5)	1.15 (1.07 to 1.23)
2013	3740 (14.6)	2655 (71.0)	1.15 (1.07 to 1.24)
2014	3310 (12.9)	2240 (67.7)	1.11 (1.04 to 1.19)
2015	4675 (18.2)	3165 (67.7)	1.10 (1.02 to 1.18)
2016	4755 (18.5)	3045 (64.0)	1.04 (0.97 to 1.12)
2017	2815 (11.0)	1765 (62.7)	1.02 (0.94 to 1.11)
2018	175 (0.7)	95 (54.3)	0.89 (0.74 to 1.06)
Season			
January–March	6025 (23.5)	4030 (66.9)	1.00 (ref)
April–June	6445 (25.1)	4215 (65.4)	0.97 (0.95 to 1.00)
July–September	6590 (25.7)	4275 (64.9)	0.95 (0.93 to 0.98)
October–December	6575 (25.6)	4325 (65.8)	0.96 (0.94 to 0.99)

a Variables for adjustment were those from [Table 3](#); Different models were adjusted for different variables according to the model of best fit.

**TABLE 62** Toddlerhood targets: year and season of delivery and fidelity targets in toddlerhood, for mothers giving birth between April 2010 and January 2018 aged 13–19 at LMP

	<b>N mothers (% of all mothers)</b>	<b>N who met toddlerhood target (% of group)</b>	<b>Adjusted RR (95% CI)<sup>a</sup></b>
<b>Total</b>	<b>19,655 (100)</b>	<b>11,900 (60.5)</b>	-
Year of delivery			
2010	1625 (8.3)	1070 (65.8)	1.00 (ref)
2011	1375 (7.0)	885 (64.4)	0.92 (0.86 to 0.98)
2012	2235 (11.4)	1490 (66.7)	0.86 (0.81 to 0.91)
2013	3150 (16.0)	2130 (67.6)	0.86 (0.82 to 0.91)
2014	2725 (13.9)	1695 (62.2)	0.81 (0.76 to 0.86)
2015	3440 (17.5)	1915 (55.7)	0.71 (0.66 to 0.76)
2016	3010 (15.3)	1630 (54.2)	0.70 (0.64 to 0.76)
2017	1970 (10.0)	1030 (52.3)	0.68 (0.62 to 0.74)
2018	125 (0.6)	50 (40.0)	0.55 (0.44 to 0.69)
Season			
January–March	4580 (23.3)	2770 (60.5)	1.00 (ref)
April–June	4950 (25.2)	2985 (60.3)	0.97 (0.94 to 1.00)
July–September	5090 (25.9)	3110 (61.1)	0.98 (0.95 to 1.00)
October–December	5035 (25.6)	3040 (60.4)	0.96 (0.93 to 0.99)

<sup>a</sup> Variables for adjustment were those from [Table 3](#); Different models were adjusted for different variables according to the model of best fit.

## Appendix 11 Timeline for data access

---

October 2017	Application submitted to DfE for NPD data Application submitted to NHS Digital for linkage between FNP, HES and NPD
December 2017	Application submitted to CAG, confidentiality advisory group/National Research Ethics
January 2018	Ethics approval confirmed
February 2018	CAG provisional approval  Delays due to security assurances for DfE not being in place: NHS Digital could not release identifiers for linkage
November 2018	Amendment submitted to NHS Digital removing request for DfE data (due to delays in security assurances being confirmed). Amendment submitted to CAG to remove DfE data
January 2019	CAG amendment approved New DARS application submitted
June 2019	DfE assurances now in place Amendment submitted to CAG to allow linkage with education data (as per original CAG application)
July 2019	CAG approval for second amendment received We were advised by NHS Digital to wait until the first application (without education data) had been approved before we submitted an amendment (for the education data)
<b>September 2019</b>	<b>Grant started</b>
November 2019	NHS Digital approval for linkage of HES and FNP data
July 2020	Linked HES – FNP data received from NHS Digital
August 2020	Amendment submitted to allow linkage with education data
March 2021	NHS Digital approval of linkage with education data
September 2021	Linkage with education data completed
October 2021	Linked education and social care data available on the ONS SRS
December 2021	HES and FNP data imported into the ONS SRS

---







EME  
HSDR  
HTA  
PGfAR  
PHR

Part of the NIHR Journals Library  
[www.journalslibrary.nihr.ac.uk](http://www.journalslibrary.nihr.ac.uk)

*This report presents independent research funded by the National Institute for Health and Care Research (NIHR).  
The views expressed are those of the author(s) and not necessarily those of the NHS, the NIHR or the  
Department of Health and Social Care*

***Published by the NIHR Journals Library***